

MAINTENANCE

CLEANING

⚠ **WARNING: Turn your Weber® gas grill off and wait for it to cool before cleaning.**

Outside surfaces — Use a warm soapy water solution to clean, then rinse with water.

⚠ **CAUTION: Do not use oven cleaner, abrasive cleansers (kitchen cleansers), cleaners that contain citrus products, or abrasive cleaning pads on grill or cart surfaces.**

Slide-out grease tray — Remove excess grease, wash with warm soapy water, then rinse.

⚠ **CAUTION: Do not line the slide-out grease tray with aluminum foil.**

Flavorizer® bars and cooking grates — Clean with a suitable stainless steel bristle brush. As needed, remove from grill and wash with warm soapy water, then rinse with water.

⚠ **CAUTION: Grill brushes should be checked for loose bristles and excessive wear on a regular basis. Replace brush if any loose bristles are found on cooking grates or brush. Weber recommends purchasing a new stainless steel grill brush at the beginning of every spring.**

⚠ **CAUTION: Do not clean your Flavorizer® bars or cooking grates in a self-cleaning oven.**

For availability of replacement cooking grates and Flavorizer® bars, contact the Customer Service Representative in your area using the contact information on our website. Log onto www.weber.com.

Catch pan — Check the catch pan for grease build-up each time you use your grill. Remove excess grease with a plastic scraper. Wash the catch pan with warm, soapy water and rinse with water. Disposable Weber® drip pans are available that fit the catch pan.

Thermometer — Wipe with warm soapy water; clean with plastic scrub ball.

Cookbox — Brush any debris off of burner tubes. DO NOT ENLARGE BURNER PORTS (OPENINGS). Wash inside of cookbox with warm soapy water and a water rinse.

Inside lid — While lid is warm, wipe inside with paper towel to prevent grease build-up. Flaking built-up grease resembles paint flakes.

Stainless steel surfaces — Wash with a soft cloth and a soap and water solution. Be careful to scrub with the grain direction of the stainless steel.

Do not use cleaners that contain acid, mineral spirits, or xylene. Rinse well after cleaning.

Preserve your stainless steel — Your grill or its cabinet, lid, and control panel may be made from stainless steel. Keeping the stainless steel looking its best is a simple matter. Clean it with soap and water, rinse with clear water, and wipe dry. For stubborn particles, a non-metallic brush can be used.

⚠ **IMPORTANT: Do not use a wire brush or abrasive cleaners on the stainless steel surfaces of your grill as this will cause scratches.**

⚠ **IMPORTANT: When cleaning surfaces be sure to rub/wipe in the direction of the grain to preserve the look of your stainless steel. ♦**

WEBER® SPIDER/INSECT SCREENS

Your Weber® gas grill, as well as any outdoor gas appliance, is a target for spiders and other insects. They can nest in the venturi section (1) of the burner tubes. This blocks the normal gas flow, and can cause the gas to flow back out of the combustion air opening. This could result in a fire in and around the combustion air openings, under the control panel, causing serious damage to your grill.

The burner tube combustion air opening is fitted with a stainless steel screen (2) to prevent spiders and other insects access to the burner tubes through the combustion air openings.

We recommend that you inspect the spider/insect screens at least once a year. (Refer to "ANNUAL MAINTENANCE.") Also inspect and clean the the spider/insect screens if any of the following symptoms should ever occur:

- A) Gas is smelled in conjunction with burner flames that appear yellow and lazy.
- B) Grill does not reach temperature.
- C) Grill heats unevenly.
- D) One or more of the burners do not ignite.

⚠ DANGER

Failure to correct the above mentioned symptoms may result in a fire, which can cause serious bodily injury or death, and cause damage to property. ♦

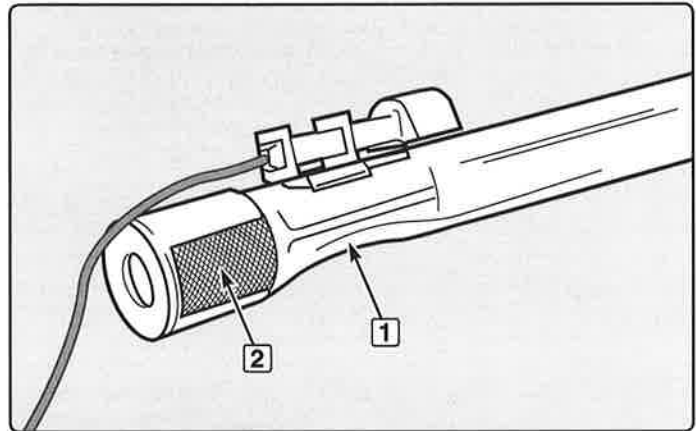

MAINTENANCE

BURNER TUBES CLEANING OR REPLACEMENT

You will need: Phillips screwdriver, flathead screwdriver, and 5/16" nut-driver.

- A) Your Weber® gas grill must be OFF and cool.
- B) Turn gas OFF at source.
- C) Remove cookbox components - warming rack, grates and Flavorizer® bars. (Heat deflectors do not need to be removed.)

Control Panel Removal

To remove control panel:

- A) Locate door pin release in door assembly. Using a screwdriver, push down on door pin release (1) until door detaches from frame assembly. Pull top of door away from frame assembly (2) and lift door off bottom adjustable hinge pin.
- B) Remove control knobs, igniter button, igniter retention nut, and battery (3).
- C) Remove screws from wind deflector (4) located underneath the control panel with a Phillips screwdriver.
- D) Tilt end of wind deflector down and slide away to remove (5).
- E) Remove igniter module from control panel (6) and remove all four wires from module.
- F) Remove screws from underside of control panel with Phillips screwdriver (7).
- G) Lift control panel up slightly, tilt up front edge and gently lift up and away (8).

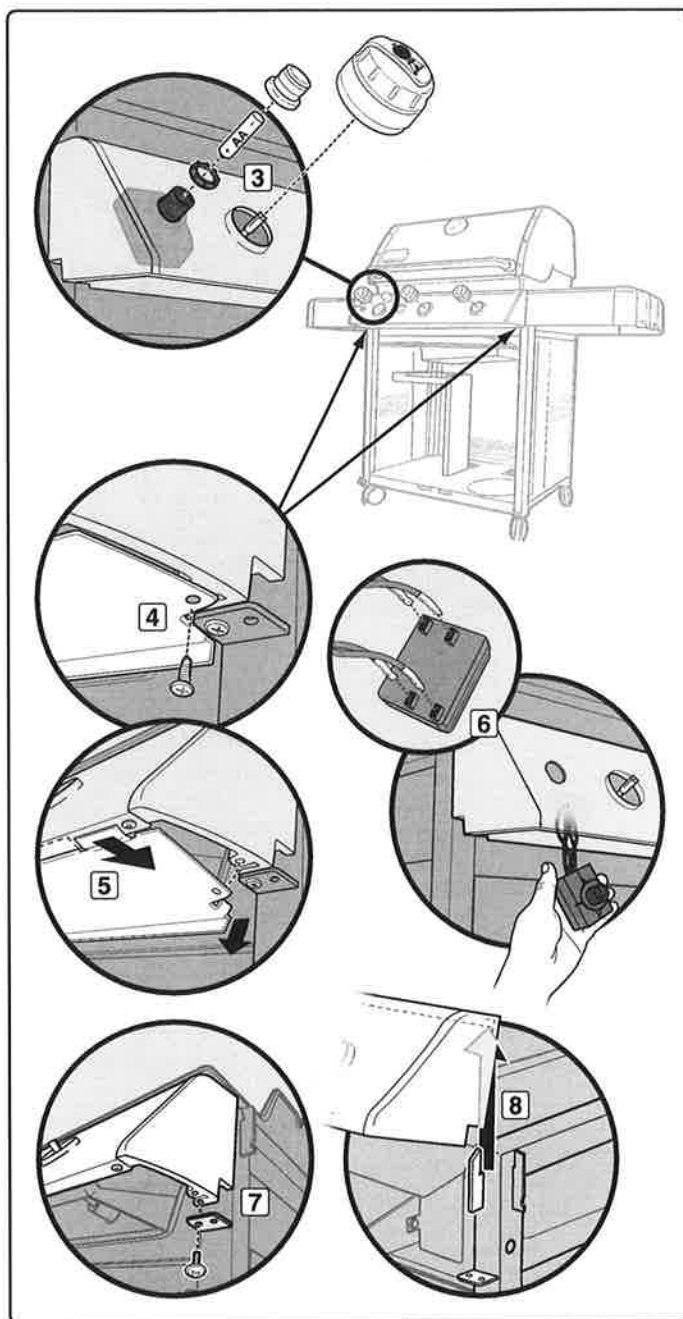
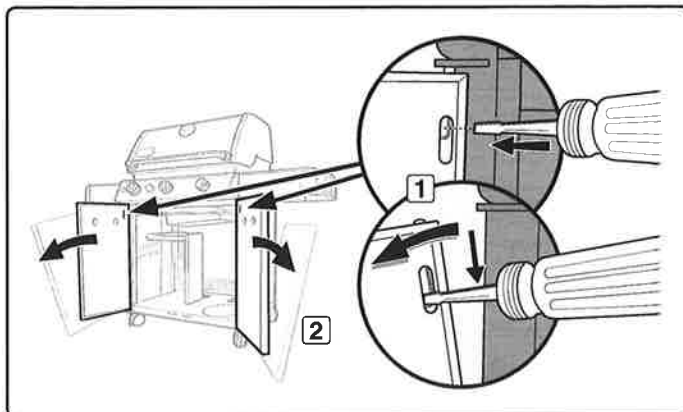

MAINTENANCE

Burner Tube Removal

To remove burner tube(s):

- Remove igniter wire(s) from igniter clip(s) (9).
- Remove screw that holds burner tube to the cookbox using a 5/16" nut-driver (10).
- Pull burner tube assembly (this includes igniter) up and out of cookbox (11).
Note: 310 units will have an additional grounding wire attached to the center burner tube (12).

Burner Tube Cleaning

To clean the burner tube(s):

- Look inside each burner with a flashlight (13).
- Clean the inside of the burners with a wire (14) (a straightened-out coat hanger will work).
- Check and clean the air shutter opening at the ends of the burners. Check and clean the valve orifices at the base of the valves. Use a steel bristle brush to clean outside of burners (15). This is to make sure all the burner ports are fully open.

⚠ **CAUTION: Do not enlarge the burner ports when cleaning.**

Burner Tube Reinstallation

To reinstall burner tubes:

- Slide burner tube and igniter wire through hole in cookbox (16). Refer to "ELECTRONIC IGNITION SYSTEM OPERATIONS" for proper burner position.
 - Align burner tube with valve.
- ⚠ **CAUTION: The burner openings (17) must be positioned properly over the valve orifices (18).**
- Re-install screw that holds the burner tube to the cookbox using a flathead screwdriver. Burner tube may seem loose (19), when screw is snug. This is normal.
 - Route wires back through igniter clips. Refer back to figure (9).

⚠ **CAUTION: All wires must be properly routed through wire clips.**

- Attach wires to module, following the numerical/color coding (20). Refer to "ELECTRONIC IGNITION SYSTEM OPERATIONS" for proper attachment of wires.

⚠ **WARNING: After reinstalling the gas lines, they should be leak checked with a soap and water solution before using the grill. (Refer to "CHECK FOR GAS LEAKS".)**

⚠ **WARNING: Make sure that all parts are assembled and hardware is fully tightened before operating the grill. Your actions, if you fail to follow this Product Warning, may cause a fire, an explosion, or structural failure resulting in serious personal injury or death as well as damage to property. ♦**

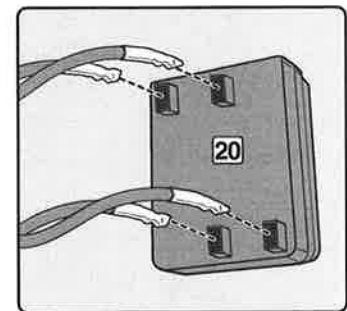
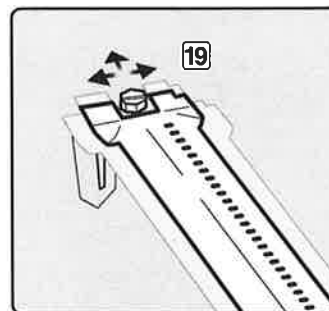
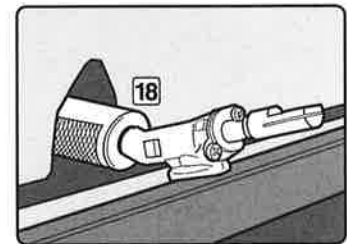
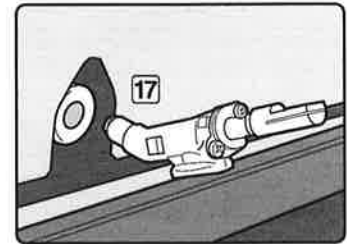
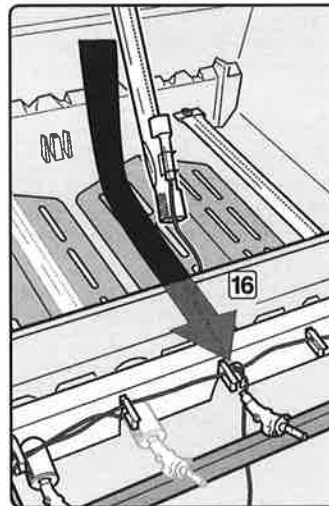
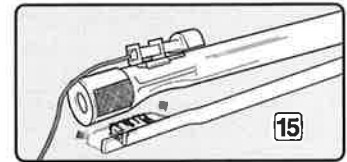
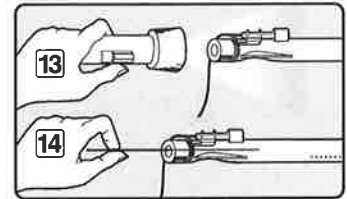
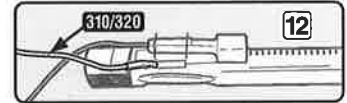
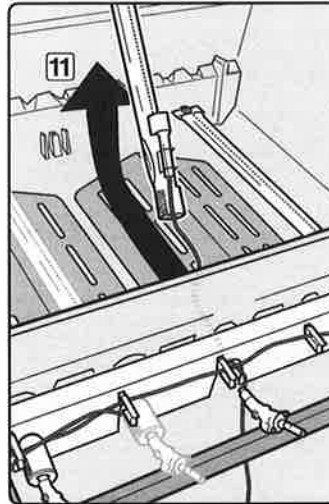
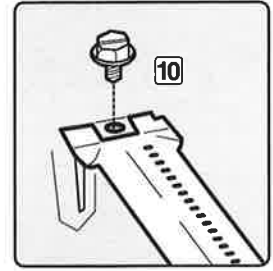
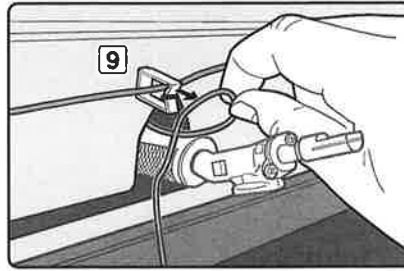

MAINTENANCE

ELECTRONIC IGNITION SYSTEM OPERATIONS

If the Electronic Ignition System fails to ignite, be sure there is gas flow by attempting to match light your burners. Refer to "MAIN BURNER MANUAL IGNITION". If match lighting is successful, the problem lies in the electronic ignition.

⚠ WARNING: All gas controls and supply valves should be in the OFF position.

- Verify that the AA battery (alkaline only) is in good condition and installed correctly (1). Some batteries have a plastic protective wrap around them. This plastic must be removed. Do not confuse this plastic with the battery label.
- Make sure the ignition wires are attached to igniter module properly. Refer to the "IGNITER MODULE WIRE GUIDE" below.
- Make sure the ceramic igniter assembly is fully positioned into burner tube igniter channel (2). If properly positioned, you will hear a snap (3).
- Make sure the Electronic Ignition button is working by listening and looking for sparks at burner.

If the Electronic Ignition System still fails to light, contact the Customer Service Representative in your area using the contact information on our web site. Log onto www.weber.com. ♦

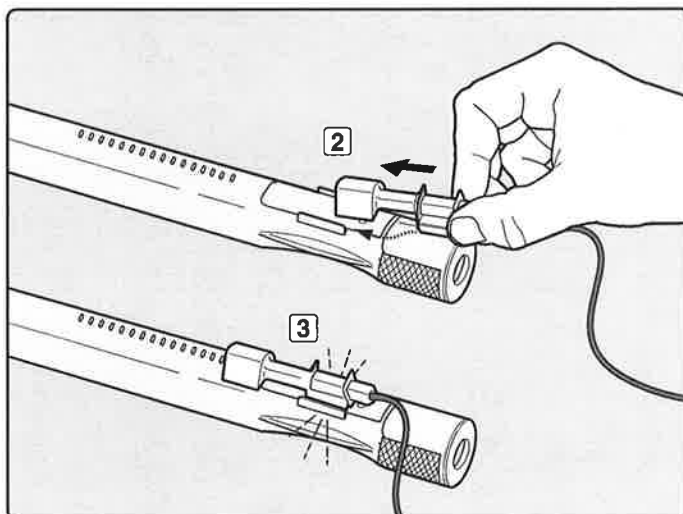
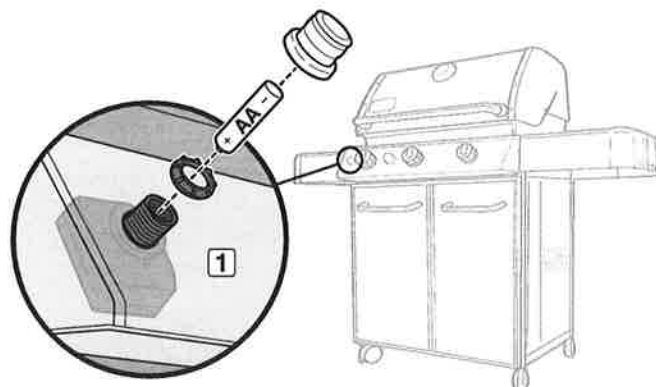

IGNITER MODULE WIRE GUIDE 310

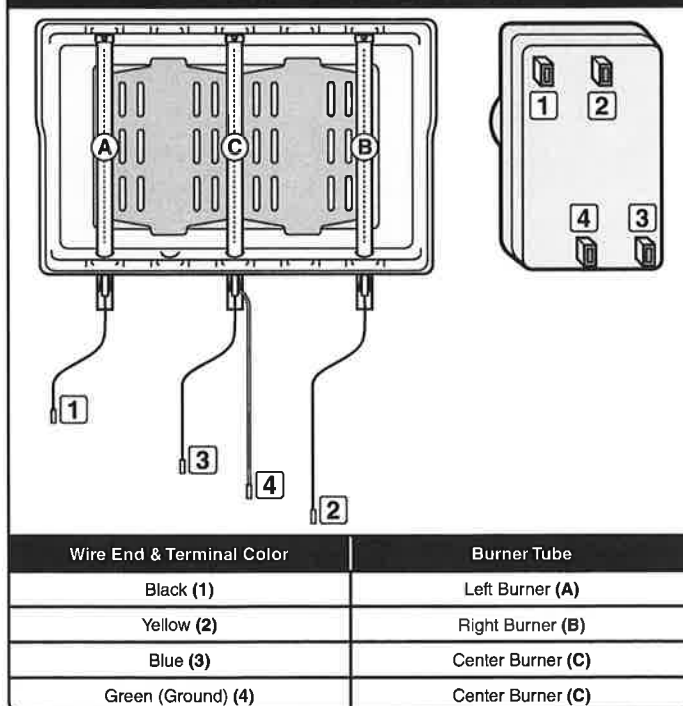

MAINTENANCE

ANNUAL MAINTENANCE

Inspection and Cleaning of the Spider/Insect Screens

To inspect the spider/insect screens, remove the control panel. If there is dust or dirt on the screens, remove the burners to clean the screens.

Brush the spider/insect screens lightly with a soft bristle brush (i.e., an old toothbrush).

⚠ CAUTION: Do not clean the spider/insect screens with hard or sharp tools. Do not dislodge the spider/insect screens or enlarge the screen openings.

Lightly tap the burner to get debris and dirt out of the burner tube. Once the spider/insect screens and burners are clean, replace the burner.

If a spider/insect screen becomes damaged or cannot be cleaned, please contact the Customer Service Representative in your area using the contact information on our web site. Log onto www.weber.com.

Burner Flame Pattern

The Weber® gas grill burners have been factory set for the correct air and gas mixture. The correct flame pattern is shown in illustration and described below:

- A) Burner tube (1)
- B) Tips occasionally flicker yellow (2)
- C) Light blue (3)
- D) Dark blue (4)

If the flames do not appear to be uniform throughout the burner tube, follow the burner cleaning procedures. ♦

