

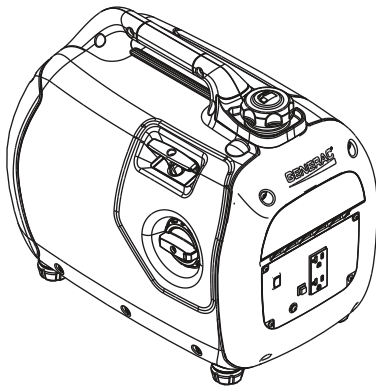

*iQ2000 Portable Generator*  
*Owner's Manual*



**MODEL:** \_\_\_\_\_

**SERIAL:** \_\_\_\_\_

**DATE PURCHASED:** \_\_\_\_\_



**WARNING**

This product is not intended to be used in a critical life support application. Failure to adhere to this warning could result in death or serious injury. (000209a)

Register your Generac product at:  
[WWW.GENERAC.COM](http://WWW.GENERAC.COM)  
1-888-GENERAC  
(1-888-436-3722)

**SAVE THIS MANUAL FOR FUTURE REFERENCE**

# Table of Contents

---

## Section 1 Introduction and Safety 1

Introduction .....	1
Safety Rules .....	1
Safety Symbols and Meanings .....	1
Exhaust and Location Hazards .....	2
Electrical Hazards .....	3
Fire Hazards .....	3
Standards Index .....	3

## Section 2 General Information and Setup 4

Know Your Generator .....	5
Emissions .....	5
Connection Plugs .....	6
PowerDial .....	6
PowerBar .....	6
Economy Switch .....	6
Generator Status Lights .....	6
Run Time Display .....	6
Fuel Sensor and Fuel Gauge .....	7
Remove Contents from Carton .....	7
Add Engine Oil .....	7
Fuel .....	8

## Section 3 Operation 9

Operation and Use Questions .....	9
Before Starting Engine .....	9
Prepare Generator for Use .....	9
Grounding the Generator When Used as a Portable .....	9
Know Generator Limits .....	9
Transporting/Tipping of the Unit ....	10
Starting Pull Start Engines .....	10
Restarting Hot Engines .....	11
Low Oil Level Shutdown System ...	11
Parallel Operation .....	11
Parallel Reset Procedure .....	12

## Section 4 Maintenance and Troubleshooting 13

Maintenance .....	13
Maintenance Schedule .....	13
Preventive Maintenance .....	13
Engine Maintenance .....	13
Storage .....	16
Troubleshooting .....	17

---

**WARNING**

California Proposition 65. Engine exhaust and some of its constituents are known to the state of California to cause cancer, birth defects, and other reproductive harm. (000004)

---

**WARNING**

California Proposition 65. This product contains or emits chemicals known to the state of California to cause cancer, birth defects, and other reproductive harm. (000005)

---

# Section 1 Introduction and Safety

## Introduction

Thank you for purchasing a Generac Power Systems Inc. product. This unit has been designed to provide high-performance, efficient operation, and years of use when maintained properly.



### WARNING

Consult Manual. Read and understand manual completely before using product. Failure to completely understand manual and product could result in death or serious injury. (000100a)

If any section of the manual is not understood, contact your nearest Independent Authorized Service Dealer (IASD), or contact Generac Customer Service at 1-888-GENERAC (1-888-436-3722), or [www.generac.com](http://www.generac.com) with any questions or concerns.

The owner is responsible for proper maintenance and safe use of the equipment. Before operating, servicing or storing this generator:

- Study all warnings in this manual and on the product carefully.
- Become familiar with this manual and the unit before use.
- Refer to **Introduction and Safety** for instructions on final assembly procedures. Follow the instructions completely.

Save these instructions for future reference. ALWAYS supply this manual to any individual that will use this machine.

The information in this manual is accurate based on products produced at the time of publication. The manufacturer reserves the right to make technical updates, corrections, and product revisions at any time without notice.

## Safety Rules

The manufacturer cannot anticipate every possible circumstance that might involve a hazard. The warnings in this manual, and on tags and decals affixed to the unit are, therefore, not all inclusive. If using a procedure, work method or operating technique that the manufacturer does not specifically recommend, verify that it is safe for others. Also make sure the procedure, work method or operating technique utilized does not render the equipment unsafe.

Throughout this publication, and on tags and decals affixed to the generator, DANGER, WARNING, CAUTION and NOTE blocks are used to alert personnel to special instructions about a particular operation that may be hazardous if performed incorrectly or carelessly. Observe them carefully. Their definitions are as follows:

### DANGER

Indicates a hazardous situation which, if not avoided, will result in death or serious injury.

(000001)

### WARNING

Indicates a hazardous situation which, if not avoided, could result in death or serious injury.

(000002)

### CAUTION

Indicates a hazardous situation which, if not avoided, could result in minor or moderate injury.

(000003)

**NOTE:** Notes contain additional information important to a procedure and will be found within the regular text of this manual.

These safety warnings cannot eliminate the hazards that they indicate. Common sense and strict compliance with the special instructions while performing the action or service are essential to preventing accidents.

## Safety Symbols and Meanings

DANGER	
Using a generator indoors CAN KILL YOU IN MINUTES. Generator exhaust contains carbon monoxide. This is a poison you cannot see or smell.	
 NEVER use inside a home or garage, EVEN IF doors and windows are open.	 Only use OUTSIDE and far away from windows, doors, and vents.

000657



### DANGER

Asphyxiation. Running engines produce carbon monoxide, a colorless, odorless, poisonous gas. Carbon monoxide, if not avoided, will result in death or serious injury. (000103)

- If you start to feel sick, dizzy, or weak after the generator has been running, move to fresh air IMMEDIATELY. See a doctor, as you could have carbon monoxide poisoning.



**⚠ DANGER**

The exhaust system must be properly maintained. Do not alter or modify the exhaust system as to render it unsafe or make it noncompliant with local codes and/or standards. Failure to do so will result in death or serious injury. (000179a)



**⚠ DANGER**

Electrocution. Water contact with a power source, if not avoided, will result in death or serious injury. (000104)



**⚠ DANGER**

Electrocution. Turn utility and emergency power supplies to OFF before connecting power source and load lines. Failure to do so will result in death or serious injury. (000116)

**⚠ WARNING**

Equipment and property damage. Do not alter construction of, installation, or block ventilation for generator. Failure to do so could result in unsafe operation or damage to the generator. (000146)



**⚠ WARNING**

Asphyxiation. Always use a battery operated carbon monoxide alarm indoors and installed according to the manufacturer's instructions. Failure to do so could result in death or serious injury. (000178a)

**⚠ WARNING**

Equipment and property damage. Do not operate unit on uneven surfaces, or areas of excessive moisture, dirt, dust or corrosive vapors. Doing so could result in death, serious injury, property and equipment damage. (000250)



**⚠ WARNING**

Moving Parts. Keep clothing, hair, and appendages away from moving parts. Failure to do so could result in death or serious injury. (000111)



**⚠ WARNING**

Hot Surfaces. When operating machine, do not touch hot surfaces. Keep machine away from combustibles during use. Hot surfaces could result in severe burns or fire. (000108)

**⚠ WARNING**

Do not insert any object through the air cooling slots. Generator can start at any time and could result in death, serious injury, and unit damage. (000142)

**⚠ WARNING**

Risk of injury. Do not operate or service this machine if not fully alert. Fatigue can impair the ability to service this equipment and could result in death or serious injury. (000215)

**⚠ WARNING**

Injury and equipment damage. Do not use generator as a step. Doing so could result in falling, damaged parts, unsafe equipment operation, and could result in death or serious injury. (000216)

- For safety reasons, it is recommended that the maintenance of this equipment be performed by an IASD. Inspect the generator regularly, and contact the nearest IASD for parts needing repair or replacement.

## Exhaust and Location Hazards



**⚠ DANGER**

Asphyxiation. Running engines produce carbon monoxide, a colorless, odorless, poisonous gas. Carbon monoxide, if not avoided, will result in death or serious injury. (000103)



**⚠ DANGER**

The exhaust system must be properly maintained. Do not alter or modify the exhaust system as to render it unsafe or make it noncompliant with local codes and/or standards. Failure to do so will result in death or serious injury. (000179a)

**⚠ WARNING**

Equipment and property damage. Do not alter construction of, installation, or block ventilation for generator. Failure to do so could result in unsafe operation or damage to the generator. (000146)



**⚠ WARNING**

Asphyxiation. Always use a battery operated carbon monoxide alarm indoors and installed according to the manufacturer's instructions. Failure to do so could result in death or serious injury. (000178a)

- If you start to feel sick, dizzy, or weak after the generator has been running, move to fresh air IMMEDIATELY. See a doctor, as you could have carbon monoxide poisoning.

---

## Electrical Hazards

---



**▲ DANGER**

Electrocution. Contact with bare wires, terminals, and connections while generator is running will result in death or serious injury. (000144)

---



**▲ DANGER**

Electrocution. Water contact with a power source, if not avoided, will result in death or serious injury. (000104)

---



**▲ DANGER**

Electrocution. In the event of electrical accident, immediately shut power OFF. Use non-conductive implements to free victim from live conductor. Apply first aid and get medical help. Failure to do so will result in death or serious injury. (000145)

---

**▲ WARNING**

Accidental Start-up. Disconnect the negative battery cable, then the positive battery cable when working on unit. Failure to do so could result in death or serious injury. (000130)

---

- The National Electric Code (NEC) requires the frame and external electrically conductive parts of the generator be properly connected to an approved earth ground. Local electrical codes may also require proper grounding of the generator. Consult with a local electrician for grounding requirements in the area.
- Use a ground fault circuit interrupter in any damp or highly conductive area (such as metal decking or steel work).

---

## Fire Hazards

---



**▲ DANGER**

Explosion and Fire. Fuel and vapors are extremely flammable and explosive. Add fuel in a well ventilated area. Keep fire and spark away. Failure to do so will result in death or serious injury. (000105)

---



**▲ DANGER**

Explosion and Fire. LP vapors are extremely flammable and explosive. Do not use or store LP cylinder in a building, garage, or enclosed area except as authorized by NFPA 58 or B149.2 (Canada). Failure to do so will result in death or serious injury. (000199)

---



**▲ DANGER**

Do not overfill fuel tank. Fill to 1/2 in. of top of tank to allow for fuel expansion. Overfilling may cause fuel to spill onto engine causing fire or explosion, which will result in death or serious injury. (000166)

---



**▲ DANGER**

Risk of fire. Allow fuel spills to completely dry before starting engine. Failure to do so will result in death or serious injury. (000174)

---

**▲ WARNING**

Do not insert any object through the air cooling slots. Generator can start at any time and could result in death, serious injury, and unit damage. (000142)

---

- Do not operate the generator if connected electrical devices overheat, if electrical output is lost, if engine or generator sparks or if flames or smoke are observed while unit is running.
- Keep a fire extinguisher near the generator at all times.

---

## Standards Index

1. National Fire Protection Association (NFPA) 70: The NATIONAL ELECTRIC CODE (NEC) available from [www.nfpa.org](http://www.nfpa.org)
2. National Fire Protection Association (NFPA) 5000: BUILDING CONSTRUCTION AND SAFETY CODE available from [www.nfpa.org](http://www.nfpa.org)
3. International Building Code available from [www.iccsafe.org](http://www.iccsafe.org)
4. Agricultural Wiring Handbook available from [www.rerc.org](http://www.rerc.org), Rural Electricity Resource Council P.O. Box 309 Wilmington, OH 45177-0309
5. ASAE EP-364.2 Installation and Maintenance of Farm Standby Electric Power available from [www.asabe.org](http://www.asabe.org), American Society of Agricultural & Biological Engineers 2950 Niles Road, St. Joseph, MI 49085

This list is not all inclusive. Check with the Authority Having Jurisdiction (AHJ) for any local codes or standards which may be applicable to your jurisdiction.

## Section 2 General Information and Setup

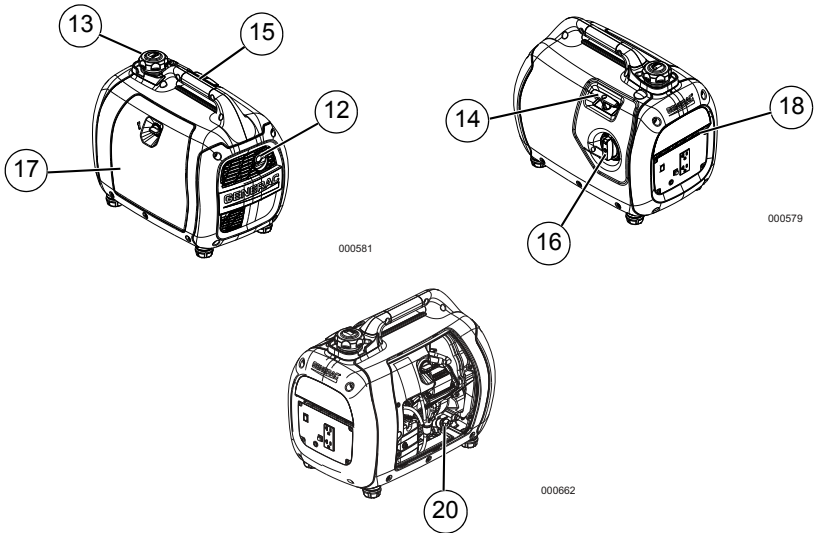

Figure 2-1. Features and Controls

TABLE 1. Generator Components

1	Parallel Ready 120 Volts AC Duplex Outlet
2	Turbo/Standard/Economy Switch
3	PowerBar
4	Grounding Location
5	Reset Button
6	Overheat LED (red)
7	Overload LED (red)
8	Low Oil LED (orange)
9	Ready to Load LED (green)
10	Fuel Gauge
11	Run Time Display
12	Muffler/Spark Arrestor
13	Fuel Cap (with vent)
14	Recoil Handle
15	Carrying Handle
16	Power Dial
17	Service Door
18	Air Intake
19	Data Label Location
20	Oil Fill

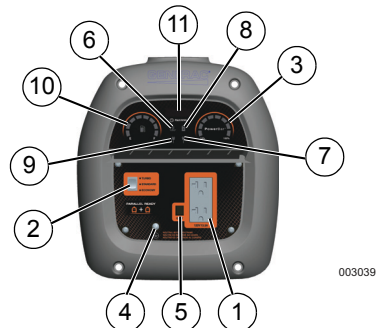

Figure 2-2. Control Panel

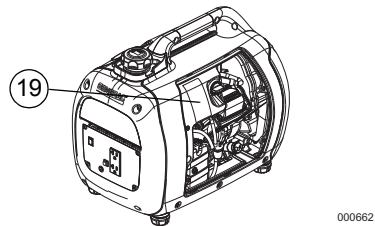

Figure 2-3. Data Label Location

## Know Your Generator



### ⚠WARNING

Consult Manual. Read and understand manual completely before using product. Failure to completely understand manual and product could result in death or serious injury. (000100a)

Replacement owner's manuals are available at [www.generac.com](http://www.generac.com).

## Emissions

The United States Environmental Protection Agency (US EPA) (and California Air Resources Board (CARB), for engines/equipment certified to California standards) requires that this engine/equipment complies with exhaust and evaporative emissions standards. Locate the emissions compliance decal on the engine to determine applicable standards. For emissions warranty information, please reference the included emissions warranty. It is important to follow the maintenance specifications in the manual to ensure that the engine complies with the applicable emissions standards for the duration of the product's life.

**TABLE 2. Product Specifications**

Generator Specifications	
Rated Power	1600 W
Starting Power	2000 W
Rated AC Voltage	120V
Rated AC Load at 120V	13.3 Amps**
Rated Frequency	60 Hz
Dimensions L x W x H (in/mm)	20.0 x 12.6 x 16.9 (507.4 x 320.8 x 428)
Weight (dry)	46.2 lb. (19.3 kg)
** Operating Temperature Range: -13 deg. C (8 deg. F) to 40 Deg. C (104 Deg. F). When operated above 25 deg. C (77 deg. F) there may be a decrease in power.	
** Maximum wattage and current are subject to, and limited by, such factors as fuel Btu content, ambient temperature, altitude, engine condition, etc.. Maximum power decreases about 3.5% for each 1,000 feet above sea level; and will also decrease about 1% for each 6° C (10° F) above 16° C (60° F) ambient temperature.	
Engine Specifications	
Engine Type	Single Cylinder, 4-stroke
Displacement	80 cc
Spark Plug Part Number	0K91470141
Spark Plug Type	NHSP LDE6RTC
Spark Plug Gap (in/mm)	0.023-0.027 (0.6-0.7)
Fuel Capacity / Type	4.0 L (1.06 U.S. gallons) / Unleaded
Oil Type	See <a href="#">Add Engine Oil</a>
Oil Capacity	0.38 L (0.4 qt.)
Run Time at 25% Load	7.7 Hours

## Connection Plugs

### 120 VAC, Duplex Receptacle

The 120 Volt outlet is overload protected by the inverter module electronic control. See [Figure 2-4](#). Each receptacle will power 120 Volt AC, single phase, 60 Hz electrical loads requiring up to 1600 watts (1.6 kW).

**NOTE:** Limit length of extension cords to fifteen feet, or less, to prevent voltage drop and overheating of wires.

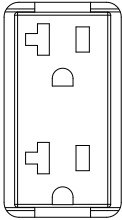

000424

Figure 2-4. 120 VAC, Duplex Receptacle

### PowerDial

The PowerDial controls the ON/OFF functions, choke and fuel valve operation. See [Figure 2-5](#).

- The START position (1) is used to start the engine. In this position, the fuel is on and the choke is fully on (closed).
- The RUN position (2) for normal operation and to gradually reduce the use of the choke.
- The STOP position (3) stops the engine and shuts off fuel flow.

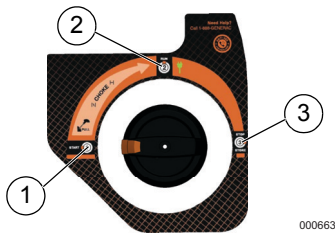

000663

Figure 2-5. PowerDial (example)

### PowerBar

See [Figure 2-6](#). The PowerBar (8) indicates the amount of power being used from the generator. Each section is approximately 12.5%.

## Economy Switch

The economy switch has 3 modes of operation:

- **Economy:** The quietest mode and best when running appliances or equipment that are resistive loads (non-motor starting), (example: TV, video game, light, radio).
- **Standard:** Best when running a both inductive (motor-starting loads) and resistive (non-motor starting loads), especially when these loads are turning on and off (example: RV, air conditioner, hairdryer).
- **Turbo:** Best when running inductive loads (appliances or equipment with motor-starting) that are continually running (examples: drill, blender, saw).

## Generator Status Lights

See [Figure 2-6](#).

- **Overheat LED (red):** Illuminates when unit temperatures exceed normal operating conditions (1). The ready LED will turn off and the inverter will cut power to the outlets. Check for airflow obstructions at front and rear panels. The engine will remain running to cool the unit with the overheat LED illuminated. Once the unit has reached normal operating temperatures, the overheat LED will turn off. The reset button must then be pressed for 1 second and released to clear the fault and restore output power.
- **Low Oil Level LED (orange):** Illuminates when oil level is below safe operating level. Engine shuts down (2).
- **Ready LED (green):** Indicates output from generator (3) (unless there is a low oil or overload condition).
- **Overload LED (red):** Indicates system overload (4). During motor starting it is normal for the overload LED to illuminate for a few seconds. If LED stays illuminated and the ready LED turns off, the engine will continue to run without output power. Remove all applied loads and determine if attached devices exceed recommended output power. Review for any faulty or shorted connections. Press and hold the reset button for 3 seconds and release. The red overload LED should turnoff. Loads can be re-applied once the green ready LED illuminates. If the red LED returns, contact an IASD.

## Run Time Display

See [Figure 2-6](#). At startup the Run Time Display (7) shows the total engine hours of the unit, then transitions to show the Run Time Remaining.





Figure 2-6. Status Indicators

## Fuel Sensor and Fuel Gauge

See [Figure 2-6](#). The fuel sensor (5) and gas gauge (6) indicate fuel remaining in the internal fuel tank. The Run Time Clock displays the amount of run time remaining for the current fuel level and applied load.

**NOTE:** The run time clock will update if load is changed to reflect different fuel consumption.

## Remove Contents from Carton

1. Open carton completely by cutting each corner from top to bottom.
2. Remove and verify carton contents prior to assembly. Carton contents should contain the following:

### TABLE 3. Accessories

Item	Qty.
Main Unit	1
Owner's Manual	1
SAE 30 Oil	1
Oil Funnel	1
Product Registration Card	3
Service Warranty	1
Emissions Warranty	1

3. Call Generac Customer Service 1-888-GENERAC (1-888-436-3722) with the unit model and serial number for any missing carton contents.
4. Record model, serial number, and date of purchase on front cover of this manual.

## Add Engine Oil

### CAUTION

Engine damage. Verify proper type and quantity of engine oil prior to starting engine. Failure to do so could result in engine damage.

(000135)

**NOTE:** The generator is shipped without oil in the engine. Add oil slowly and verify oil level often during filling process to ensure overfilling does not occur.

1. Place generator on a level surface.
2. Clean area around oil fill and oil drain plug.
3. Remove oil fill cap and wipe dipstick clean. See [Figure 2-7](#).

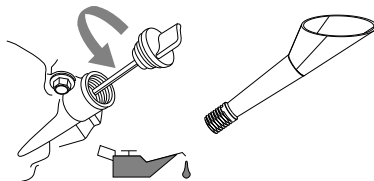

000804

Figure 2-7. Remove Dipstick

4. Screw funnel into oil fill opening. Add recommended engine oil as necessary. Climate determines proper engine oil viscosity. See chart to select correct viscosity.

**NOTE:** Use petroleum based oil (supplied) for engine break-in before using synthetic oil.

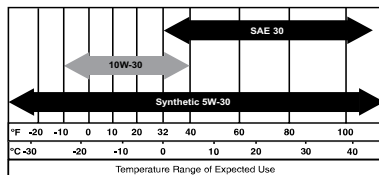

000399

5. To check oil level, remove funnel and insert dipstick into oil filler neck **without** screwing it in. See [Figure 2-8](#).

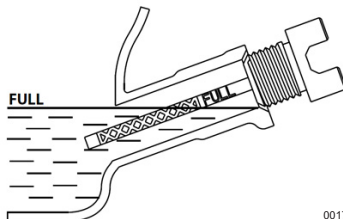

001792

Figure 2-8. Safe Operating Range

- Remove dipstick and verify oil level is within safe operating range.

**NOTE:** Verify oil level often during filling process to ensure overfilling does not occur.

- Install oil fill cap/dipstick and hand-tighten.

## Fuel



### **▲DANGER**

Explosion and Fire. Fuel and vapors are extremely flammable and explosive. Add fuel in a well-ventilated area. Keep fire and spark away. Failure to do so will result in death or serious injury.

(000105)



### **▲DANGER**

Do not overfill fuel tank. Fill to 1/2 in. of top of tank to allow for fuel expansion. Overfilling may cause fuel to spill onto engine causing fire or explosion, which will result in death or serious injury.

(000166)

Fuel requirements are as follows:

- Clean, fresh, unleaded gasoline.
  - Minimum rating of 87 octane/87 AKI (91 RON).
  - Up to 10% ethanol (gasohol) is acceptable.
  - DO NOT use E85.
  - DO NOT use a gas oil mix.
  - DO NOT modify engine to run on alternate fuels. Stabilize fuel prior to storage.
1. Verify unit is OFF and cooled entirely prior to fueling.
  2. Place unit on level ground in a well ventilated area.
  3. Clean area around fuel cap and turn vent on fuel cap to ON. See [Figure 2-9](#).

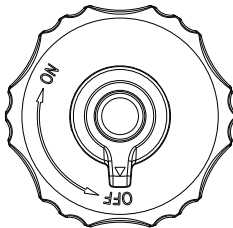

000112

**Figure 2-9. Fuel Cap**

4. Turn cap slowly to remove.
5. Slowly add recommended fuel. DO NOT overfill.
  - Fill to red insert inside filler neck. See [Figure 2-10](#).
6. Install fuel cap.
7. Turn vent on fuel cap to OFF for transportation and storage.

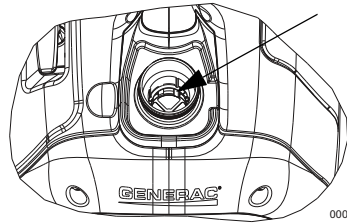

000820

**Figure 2-10. Internal Fuel Tank Level**

**NOTE:** Allow spilled fuel to evaporate before starting unit.

**IMPORTANT NOTE:** It is important to prevent gum deposits from forming in fuel system parts such as the carburetor, fuel hose or tank during storage. Alcohol-blended fuels (called gasohol, ethanol or methanol) can attract moisture, which leads to separation and formation of acids during storage. Acidic gas can damage the fuel system of an engine while in storage. To avoid engine problems, the fuel system should be emptied before storage of 30 days or longer. See the [Storage](#) section. Never use engine or carburetor cleaner products in the fuel tank as permanent damage may occur.

## Section 3 Operation

### Operation and Use Questions

Call Generac customer service at 1-888-GENERAC (1-888-436-3722) with questions or concerns about equipment operation and maintenance.

### Before Starting Engine

1. Verify engine oil level is correct.
2. Verify fuel level is correct.
3. Verify unit is secure on level ground, with proper clearance and is in a well ventilated area.

### Prepare Generator for Use



#### **⚠ DANGER**

Asphyxiation. Running engines produce carbon monoxide, a colorless, odorless, poisonous gas. Carbon monoxide, if not avoided, will result in death or serious injury. (000103)



#### **⚠ DANGER**

The exhaust system must be properly maintained. Do not alter or modify the exhaust system as to render it unsafe or make it noncompliant with local codes and/or standards. Failure to do so will result in death or serious injury. (000179a)



#### **⚠ WARNING**

Risk of fire. Do not use generator without spark arrestor installed. Failure to do so could result in death or serious injury. (000118a)



#### **⚠ WARNING**

Asphyxiation. Always use a battery operated carbon monoxide alarm indoors and installed according to the manufacturer's instructions. Failure to do so could result in death or serious injury. (000178a)



#### **⚠ WARNING**

Risk of Fire. Hot surfaces could ignite combustibles, resulting in fire. Fire could result in death or serious injury. (000110)



#### **⚠ WARNING**

Hot Surfaces. When operating machine, do not touch hot surfaces. Keep machine away from combustibles during use. Hot surfaces could result in severe burns or fire. (000108)

#### **⚠ CAUTION**

Equipment and property damage. Disconnect electrical loads prior to starting or stopping unit. Failure to do so could result in equipment and property damage. (000136)

### Grounding the Generator When Used as a Portable

The generator is equipped with a terminal for the connection of a grounding electrode system. Article 250.34 (A) does not require the frame of the generator to be connected to a grounding electrode system when the generator only supplies power to cord and plug connected equipment through the receptacles on the generator.

When the generator supplies power to a 3-pole manual transfer switch or distribution panel boards for temporary power, a grounding electrode system shall be installed and connected to the grounding electrode terminal on the generator. See NEC 250.30, 250.34 and 250.52 for clarification.

See [Figure 3-1](#).

- Neutral Bonded to Frame

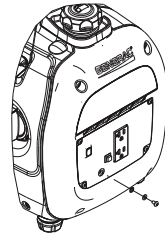

000808

Figure 3-1. Grounding the Generator

### Know Generator Limits

Overloading a generator can result in damage to the generator and connected electrical devices. Observe the following to prevent overload:

- Add up the total wattage of all electrical devices to be connected at one time. This total should NOT be greater than the generator's wattage capacity.
  - The rated wattage of lights can be taken from light bulbs. The rated wattage of tools, appliances, and motors can be found on a data label or decal affixed to the device.
  - If the appliance, tool, or motor does not give wattage, multiply volts times ampere rating to determine watts (volts x amps = watts).
  - Some electric motors, such as induction types, require about three times more watts of power for starting than for running. This surge of power lasts only a few seconds when starting such motors. Make sure to allow for high starting wattage when selecting electrical devices to connect to the generator:
1. Figure the watts needed to start the largest motor.

2. Add to that figure the running watts of all other connected loads.

**Wattage Reference Guide** is provided to assist in determining how many items the generator can operate at one time.

**NOTE:** All figures are approximate. See data label on appliance for wattage requirements.

**Wattage Reference Guide**

Device	Running Watts
*Air Conditioner (12,000 Btu)	1700
*Air Conditioner (24,000 Btu)	3800
*Air Conditioner (40,000 Btu)	6000
Battery Charger (20 Amp)	500
Belt Sander (3")	1000
Chain Saw	1200
Circular Saw (6-1/2")	800 to 1000
*Clothes Dryer (Electric)	5750
*Clothes Dryer (Gas)	700
*Clothes Washer	1150
Coffee Maker	1750
*Compressor (1 HP)	2000
*Compressor (3/4 HP)	1800
*Compressor (1/2 HP)	1400
Curling Iron	700
*Dehumidifier	650
Disc Sander (9")	1200
Edge Trimmer	500
Electric Blanket	400
Electric Nail Gun	1200
Electric Range (per element)	1500
Electric Skillet	1250
*Freezer	700
*Furnace Fan (3/5 HP)	875
*Garage Door Opener	500 to 750
Hair Dryer	1200
Hand Drill	250 to 1100
Hedge Trimmer	450
Impact Wrench	500
Iron	1200
*Jet Pump	800
Lawn Mower	1200
Light Bulb	100
Microwave Oven	700 to 1000
*Milk Cooler	1100
Oil Burner on Furnace	300

Oil Fired Space Heater (140,000 Btu)	400
Oil Fired Space Heater (85,000 Btu)	225
Oil Fired Space Heater (30,000 Btu)	150
*Paint Sprayer, Airless (1/3 HP)	600
Paint Sprayer, Airless (hand-held)	150
Radio	50 to 200
*Refrigerator	700
Slow Cooker	200
*Submersible Pump (1-1/2 HP)	2800
*Submersible Pump (1 HP)	2000
*Submersible Pump (1/2 HP)	1500
*Sump Pump	800 to 1050
*Table Saw (10")	1750 to 2000
Television	200 to 500
Toaster	1000 to 1650
Weed Trimmer	500
* Allow 3 times the listed watts for starting these devices.	

**Transporting/Tipping of the Unit**

Do not store or transport the unit at an angle greater than 15 degrees.

**Starting Pull Start Engines**



**WARNING**

Recoil Hazard. Recoil could retract unexpectedly. Kickback could result in death or serious injury.

(000183)

**CAUTION**

Equipment and property damage. Disconnect electrical loads prior to starting or stopping unit. Failure to do so could result in equipment and property damage.

(000136)

1. Turn fuel cap vent ON. See **Figure 2-9**.
2. See **Figure 3-2**. Rotate the PowerDial to START (1).
3. Switch Economy switch to TURBO.
4. Firmly grasp recoil handle and pull slowly until increased resistance is felt. Pull rapidly up and away.

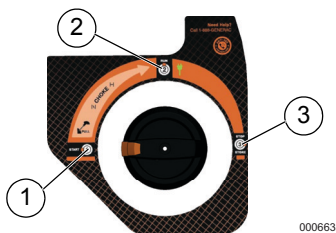

**Figure 3-2. PowerDial Positions**

- See [Figure 3-2](#). When engine starts, rotate PowerDial to RUN (2). Choke operation is reduced as PowerDial is rotated towards RUN. If engine falters, rotate PowerDial counterclockwise to START (1) to increase choke. When engine runs smoothly, rotate back to RUN.

**NOTE:** If engine fires, but does not continue to run, rotate the PowerDial to START and repeat starting instructions.

**IMPORTANT NOTE:** Do not overload generator or individual panel receptacles. See [Figure 3-3](#). If an overload occurs, the overload LED (A) will illuminate and AC output ceases. Press and hold the reset button for 3 seconds to reset the fault condition while the unit is running. Read [Know Generator Limits](#) carefully.



**Figure 3-3. Shutdown Fault Generator Shut Down**

**CAUTION**

Equipment and property damage. Disconnect electrical loads prior to starting or stopping unit. Failure to do so could result in equipment and property damage.

(000136)

- Shut off all loads and unplug electrical loads from generator panel receptacles.
- Let engine run at no-load for several minutes to stabilize internal temperatures of engine and generator.
- See [Figure 3-2](#). Rotate PowerDial clockwise to STOP (3).
- Turn fuel cap OFF.

## Restarting Hot Engines

**CAUTION**

Equipment and property damage. Disconnect electrical loads prior to starting or stopping unit. Failure to do so could result in equipment and property damage.

(000136)

- See [Figure 3-2](#). Turn PowerDial counterclockwise, from STOP until just past RUN. This will open the fuel valve and permit starting.
- Firmly grasp recoil handle and pull slowly until increased resistance is felt. Pull rapidly up and away.
- Turn PowerDial clockwise to RUN.

## Low Oil Level Shutdown System

The engine is equipped with a low oil level sensor that shuts down the engine automatically when the oil level drops below a specified level to prevent engine damage. See [Figure 3-3](#) (B). The engine will not run until the oil has been filled to the proper level.

If the engine shuts down and there is sufficient fuel, check engine oil level.

## Parallel Operation

For output power up to 3200W, two iQ2000 inverters can operate in parallel using Generac's Smart Parallel Kit (optional). See the Smart Parallel Kit Operator's Manual or contact an IASD.

**NOTE:** All connections to the parallel kit should be made while both inverters are turned off and all loads disconnected.

- The economy switch for both units must be matching and set to either standard or turbo.
- Make appropriate parallel connections to the 120V duplex outlets on each iQ2000 inverter as outlined in the owner's manual supplied with the kit.

**NOTE:** Do not disconnect any parallel kit connections once the units are running.

- Start both units per starting instructions. Once the green output indicator illuminates, devices can be connected and turned on using the parallel kit outlet.
- Follow [Generator Shut Down](#) instructions.

**NOTE:** Load applied to the parallel kit is not to exceed 3200 watts.

**NOTE:** Only use Generac approved parallel kit.

---

## Parallel Reset Procedure

1. Turn OFF all loads applied to generators.
2. See [Figure 3-4](#). Remove the 30A plug from parallel kit. DO NOT unplug parallel kit from generators.

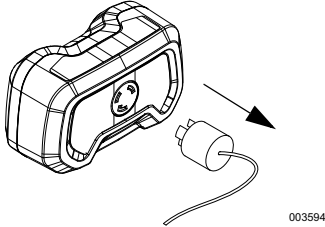

**Figure 3-4. Remove 30A Plug**

3. See [Figure 3-5](#). Press and hold the Reset button (1) on unit A for three (3) seconds, then release.
4. See [Figure 3-5](#). Wait for the red Overload light (2) to turn OFF and the green Ready light (3) to turn ON.



**Figure 3-5. Reset Button and Status Lights**

5. See [Figure 3-5](#). Repeat steps 3 and 4 for unit B.
6. Insert 30A plug into parallel kit.
7. Apply loads. After each load is applied, observe power usage displayed on Powerbar. DO NOT exceed 100%.

**NOTE:** See [Figure 3-5](#). If red Overload light (2) persists after five (5) attempts, contact Generac customer service at 1-888-GENERAC (1-888-436-3722).

## Section 4 Maintenance and Troubleshooting

### Maintenance

Regular maintenance will improve performance and extend engine/equipment life. Generac Power Systems, Inc. recommends that all maintenance work be performed by an Independent Authorized Service Dealer (IASD). Regular maintenance, replacement, or repair of the emissions control devices and systems may be performed by any repair shop or person of the owner's choosing. To obtain emissions control warranty service free of charge, the work must be performed by an IASD. See the emissions warranty.

**NOTE:** Call 1-888-GENERAC (1-888-436-3722) with questions about component replacement.

### Maintenance Schedule

Follow maintenance schedule intervals, whichever occurs first according to use.

**NOTE:** Adverse conditions will require more frequent service.

**NOTE:** All required service and adjustments should be each season as detailed in the following chart.

At Each Use
Check engine oil level
Every 50 Hours
Clean/Replace Air Filter**
Every 100 Hours or Every Season*
Change oil †
Replace Spark Plug
Clean Spark Arrestor
Valve Clearance Adjustment
Every 200 Hours or Every Season
Inspect/clean air cleaner filter**
Replace Fuel Filter +
† Change oil after first 30 hours of operation, then every season. + To be performed by IASD * Change oil every month when operating under heavy load or in high temperatures. ** Clean more often under dirty or dusty operating conditions. Replace air filter parts if they cannot be adequately cleaned. *** Check valve clearance and adjust if necessary after first 50 hours of operation and every 100 hours thereafter.

### Preventive Maintenance

Dirt or debris can cause improper operation and equipment damage. Clean generator daily or before each use. Keep area around and behind muffler free from combustible debris. Inspect all cooling air openings on generator.

#### **WARNING**

Do not insert any object through the air cooling slots. Generator can start at any time and could result in death, serious injury, and unit damage.

(000142)

- Use a damp cloth to wipe exterior surfaces clean.
- Use a soft bristle brush to loosen caked on dirt, oil, etc.
- Use a vacuum to pick up loose dirt and debris.
- Low pressure air (not to exceed 25 psi) may be used to blow away dirt. Inspect cooling air slots and openings on generator. These openings must be kept clean and unobstructed.

**NOTE:** DO NOT use a garden hose to clean generator. Water can enter engine fuel system and cause problems. If water enters generator through cooling air slots, some water will be retained in voids and crevices of rotor and stator winding insulation. Water and dirt buildup on generator internal windings will decrease insulation resistance of windings.

### Engine Maintenance

#### **WARNING**

Accidental start-up. Disconnect spark plug wires when working on unit. Failure to do so could result in death or serious injury.

(000141)

### Engine Oil Recommendations

To maintain the product warranty, the engine oil should be serviced in accordance with the recommendations of this manual. For your convenience, maintenance kits designed and intended for use on this product are available from the manufacturer that include engine oil, oil filter, air filter, spark plug(s), a shop towel and funnel. These kits can be obtained from an Independent Authorized Service Dealer (IASD).

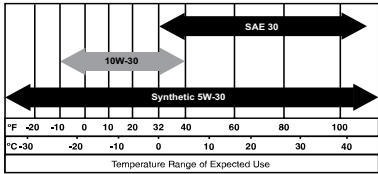

000399

## Inspect Engine Oil Level



### WARNING

Risk of burns. Allow engine to cool before draining oil or coolant. Failure to do so could result in death or serious injury.

(000139)

Inspect engine oil level prior to each use, or every 8 hours of operation.

1. Place generator on a level surface.
2. Clean area around oil fill, and oil drain plug.
3. Remove oil fill cap and wipe dipstick clean. See [Figure 4-1](#).

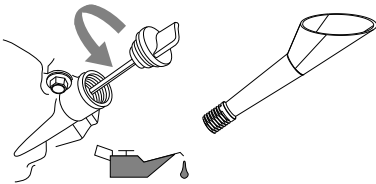

000804

**Figure 4-1. Engine Oil Fill**

4. To check oil level, insert dipstick into oil filler neck without screwing it in. See [Figure 4-2](#).

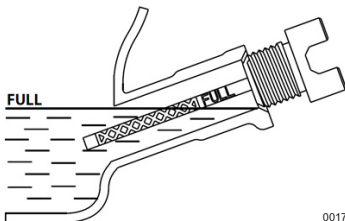

001792

**Figure 4-2. Safe Operating Range**

5. Remove dipstick and verify oil level is within safe operating range.
6. Add recommended engine oil as necessary.

**NOTE:** Verify oil level often during filling process to ensure overfilling does not occur.

7. Replace oil fill cap and hand-tighten.

**NOTE:** Some units have more than one oil fill location. It is only necessary to use one oil fill point.

## Change Engine Oil

### WARNING

Accidental start-up. Disconnect spark plug wires when working on unit. Failure to do so could result in death or serious injury.

(000141)

When using generator under extreme, dirty, dusty conditions, or in extremely hot weather, change oil more frequently.

**NOTE:** Don't pollute. Conserve resources. Return used oil to collection centers.

Change oil while engine is still warm from running, as follows:

1. Place generator on a level surface.
2. Disconnect the spark plug wire from the spark plug and place the wire where it cannot contact spark plug.
3. Clean area around oil fill and oil drain plug.
4. Remove oil fill cap and wipe dipstick clean. Screw funnel into oil fill opening. See [Figure 4-3](#).

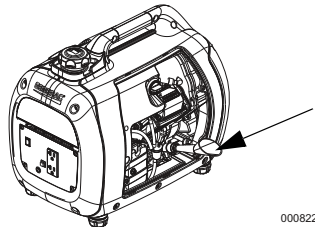

000822

**Figure 4-3. Oil Fill Opening With Funnel**

5. Tip unit and drain oil completely into a suitable container.
  6. Once oil is sufficiently drained from unit, tip unit back to a level position.
  7. Add recommended engine oil as necessary.
  8. To check oil level, remove funnel and insert dipstick into oil filler neck without screwing it in. See [Figure 4-2](#).
  9. Remove dipstick and verify oil level is within safe operating range.
- NOTE:** Verify oil level often during filling process to ensure overfilling does not occur.
10. Replace oil fill cap and hand-tighten.
  11. Wipe up any spilled oil.
  12. Properly dispose of oil in accordance with all applicable regulations.



## Air Filter

Engine will not run properly and may be damaged if run with a dirty air filter. Service air filter more frequently in dirty or dusty conditions.

To service air filter:

1. See **Figure 4-4**. Turn knob and remove service door (A).
2. Unscrew bolt (B) and remove air filter cover (C).
3. Wash filter (D) in soapy water. Squeeze dry in clean cloth (DO NOT TWIST).
4. Clean air filter cover before re-installing it.

**NOTE:** To order a new air filter, contact the nearest authorized service center at 1-888-GENERAC (1-888-436-3722).

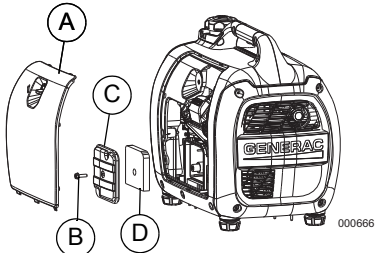
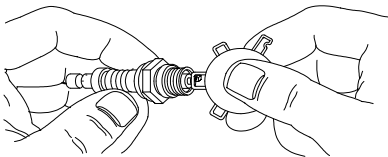

Figure 4-4. Air Filter Assembly

## Service Spark Plug

To service spark plug:

1. Clean area around spark plug.
2. Remove and inspect spark plug.
3. Inspect electrode gap with wire feeler gauge and reset spark plug gap to 0.6 - 0.7mm (0.024 - 0.028 in). See **Figure 4-5**.



000211

Figure 4-5. Spark Plug

**NOTE:** Replace spark plug if electrodes are pitted, burned or porcelain is cracked. Use ONLY recommended replacement plug. See Specifications.

4. Install spark plug finger tight, and tighten an additional 3/8 to 1/2 turn using spark plug wrench.

## Inspect Muffler and Spark Arrester

**NOTE:** It is a violation of California Public Resource Code, Section 4442, to use or operate the engine on any forest-covered, brush-covered, or grass-covered land unless the exhaust system is equipped with a spark arrester, as defined in Section 4442, maintained in effective working order. Other states or federal jurisdictions may have similar laws.

Contact original equipment manufacturer, retailer, or dealer to obtain a spark arrester designed for exhaust system installed on this engine.

**NOTE:** Use ONLY original equipment replacement parts.

Inspect muffler for cracks, corrosion, or other damage. Remove spark arrester, if equipped, inspect for damage or carbon blockage. Replace parts as required.

## Inspect Spark Arrester Screen



### WARNING

Hot Surfaces. When operating machine, do not touch hot surfaces. Keep machine away from combustibles during use. Hot surfaces could result in severe burns or fire. (000108)

## Clean Spark Arrestor Screen (50 State)

The engine exhaust muffler has a spark arrestor screen. Inspect and clean the screen every 100 hours of operation or once each year, whichever comes first.

To service spark arrestor:

1. See **Figure 4-6**. Remove the clamp (A) to remove retainer (B).
2. Slide spark arrestor screens (C) out from the muffler outlet tube (D).
3. Inspect screens and replace if torn, perforated or otherwise damaged. Do NOT use a defective screen. If screen is not damaged, clean with a commercial solvent.
4. Replace the screens, and retainer, and secure with clamp.

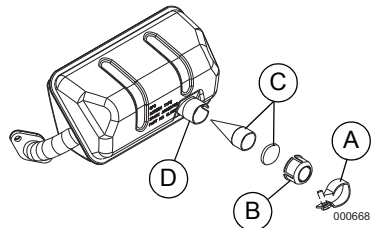

Figure 4-6. Spark Arrestor Screen

---

## Valve Clearance

**IMPORTANT NOTE: If uncomfortable about doing this procedure, or the proper tools are not available, take generator to the nearest service center to have valve clearance adjusted.**

Check valve clearance after the first fifty-hours of operation. Adjust as necessary.

- Intake — 0.10 ± 0.02mm (cold), (0.004" ± 0.001" inches)
- Exhaust — 0.10 ± 0.02mm (cold) (0.004" ± 0.001" inches)

## Storage

### General

**⚠ DANGER**

Explosion and Fire. Fuel and vapors are extremely flammable and explosive. Store fuel in a well ventilated area. Keep fire and spark away. Failure to do so will result in death or serious injury. (000143)

**⚠ WARNING**

Risk of Fire. Verify machine has properly cooled before installing cover and storing machine. Hot surfaces could result in fire. (000109)

It is recommended to start and run the generator for 30 minutes, every 30 days. If this is not possible, refer to the following list to prepare unit for storage.

- DO NOT place a storage cover on a hot generator. Allow unit to cool to room temperature before storage.
- DO NOT store fuel from one season to another unless properly treated.
- Replace fuel container if rust is present. Rust in fuel will cause fuel system problems.
- Cover unit with a suitable protective, moisture resistant cover.
- Store unit in a clean, dry area.
- Always store generator and fuel away from heat and ignition sources.

## Prepare Fuel System/Engine for Storage

Fuel stored over 30 days can go bad and damage fuel system components. Keep fuel fresh, use fuel stabilizer.

If fuel stabilizer is added to fuel system, prepare and run engine for long term storage. Run engine for 10-15 minutes to circulate stabilizer throughout fuel system. Adequately prepared fuel can be stored up to 24 months.

**NOTE:** If fuel has not been treated with fuel stabilizer, it must be drained into an approved container. Run engine until it stops from lack of fuel. Use of fuel stabilizer in fuel storage container is recommended to keep fuel fresh.

1. Change engine oil.
2. Remove spark plug.
3. Pour tablespoon (5-10cc) of clean engine oil or spray a suitable fogging agent into cylinder.

**⚠ WARNING**

Vision Loss. Eye protection is required to avoid spray from spark plug hole when cranking engine. Failure to do so could result in vision loss. (000181)

4. Pull starter recoil several times to distribute oil in cylinder.
5. Install spark plug.
6. Pull recoil slowly until resistance is felt. This will close valves so moisture cannot enter engine cylinder. Gently release recoil.

## Change Oil

Change engine oil before storage. See, [Change Engine Oil](#).

## Troubleshooting

PROBLEM	CAUSE	CORRECTION
Engine won't start.	<ol style="list-style-type: none"> <li>1. PowerDial turned off.</li> <li>2. Out of fuel.</li> <li>3. Defective spark plug.</li> <li>4. Plugged fuel filter.</li> <li>5. Defective or stuck PowerDial assembly.</li> <li>6. Incorrect engine oil level.</li> <li>7. Defective ignition coil.</li> <li>8. Fuel cap vent OFF.</li> <li>9. Carb is flooded.</li> <li>10. Throttle plate closed.</li> </ol>	<ol style="list-style-type: none"> <li>1. Turn on PowerDial.</li> <li>2. Fill fuel tank.</li> <li>3. Replace spark plug.</li> <li>4. Contact IASD.</li> <li>5. Contact IASD.</li> <li>6. Check/fill engine oil.</li> <li>7. Contact IASD.</li> <li>8. Turn fuel cap vent ON.</li> <li>9. Drain carb.</li> <li>10. Open throttle plate (push toward back of unit).</li> </ol>
Engine starts, then shuts down.	<ol style="list-style-type: none"> <li>1. Out of fuel.</li> <li>2. Incorrect engine oil level.</li> <li>3. Contaminated fuel.</li> <li>4. Defective low oil level switch.</li> <li>5. Fuel cap vent OFF.</li> </ol>	<ol style="list-style-type: none"> <li>1. Fill fuel tank.</li> <li>2. Check engine oil level.</li> <li>3. Contact IASD.</li> <li>4. Contact IASD.</li> <li>5. Turn fuel cap vent ON.</li> </ol>
Engine will not start; or starts and runs rough.*	<ol style="list-style-type: none"> <li>1. Choke is stuck or left on.</li> <li>2. Dirty or clogged air filter.</li> <li>3. Defective or dirty spark plug.</li> <li>4. Dirty fuel filter.</li> <li>5. Dirty or gummed up carburetor.</li> <li>6. Unit not warmed up.</li> <li>7. Fuel cap vent OFF.</li> </ol>	<ol style="list-style-type: none"> <li>1. Turn choke off.</li> <li>2. Clean or replace air filter.</li> <li>3. Replace spark plug.</li> <li>4. Replace fuel and fuel filter.</li> <li>5. Clean carburetor.</li> <li>6. Gradually adjust PowerDial and reduce choke until engine runs smoothly in RUN position.</li> <li>7. Turn fuel cap vent ON.</li> </ol>
No AC output.	<ol style="list-style-type: none"> <li>1. Generator is overloaded.</li> <li>2. Inverter module is overheated.</li> <li>3. Short circuit in electrical device.</li> <li>4. Defective inverter assembly.</li> </ol>	<ol style="list-style-type: none"> <li>1. Disconnect all loads. Shut down generator to reset module. Reduce loads, restart generator.</li> <li>2. Verify service door is ON. Let cool 15 minutes by running engine without AC output. Press and hold Reset button on control panel, restart generator.</li> <li>3. Verify condition of extension cords and items being powered. Press and hold Reset button on control panel.</li> <li>4. Contact IASD.</li> </ol>
Fuel leaks from drain hoses.	<ol style="list-style-type: none"> <li>1. Carburetor drain in bowl is not closed.</li> </ol>	<ol style="list-style-type: none"> <li>1. Turn valve clockwise to close.</li> </ol>
* Engine speed increases and decreases — This is normal as generator starts up and loads vary.		



Part No. 1000003992 Rev. A 09/23/2016  
©2016 Generac Power Systems, Inc. All rights reserved.  
Specifications are subject to change without notice.  
No reproduction allowed in any form without prior written consent from Generac Power Systems, Inc.

Generac Power Systems, Inc.  
S45 W29290 Hwy. 59  
Waukesha, WI 53189  
1-888-GENERAC (1-888-436-3722)  
[generac.com](http://generac.com)