



Model: 796.4100\*

# Kenmore Elite<sup>®</sup>

## Front-Loading Automatic Washer

\* = color number



MFL68005553

Sears Brands Management Corporation  
Hoffman Estates, IL 60179 U.S.A.  
[www.kenmore.com](http://www.kenmore.com)

Sears Canada Inc.  
Toronto, Ontario, Canada M5B 2C3  
[www.sears.ca](http://www.sears.ca)



## TABLE OF CONTENTS

<b>IMPORTANT SAFETY INSTRUCTIONS</b> .....	3-5
<b>GROUNDING REQUIREMENTS</b> .....	5
<b>FEATURES AND BENEFITS</b>	
Key Parts and Components .....	6
Included Accessories .....	6
Optional Accessories.....	6
<b>INSTALLATION REQUIREMENTS</b>	
Key Dimensions and Specifications .....	7
Choose the Proper Location.....	7
Flooring .....	7
Clearances.....	7
<b>INSTALLATION INSTRUCTIONS</b>	
Unpacking and Removing Shipping Bolts.....	8
Connecting the Water Lines.....	9
Connecting the Drain Hose .....	10
Connecting to the Power Supply.....	10
Leveling the Washer.....	11
Installation of Non-Skid Pads (optional).....	11
<b>HOW TO USE</b>	
Control Panel Features.....	12
Operating the Washer .....	13
Cycle Guide .....	14-15
Sorting Wash Loads.....	16
About the Dispenser Drawer.....	17
Detergent and Dispenser Use .....	18
Time and Status Display.....	19
Cycle Modifier Buttons.....	20
Steam Cycles and Options.....	21-22
Special Functions.....	23
Dry .....	24
<b>CARE AND CLEANING</b>	
Regular Cleaning .....	25-26
Maintenance.....	27-28
Cleaning the Water Inlet Filters.....	27
Cleaning the Drain Pump Filter.....	28
<b>DIAGNOSTICS</b>	
Using Diagnostics .....	29
<b>TROUBLESHOOTING GUIDE</b>	
Normal Sounds You May Hear.....	30
Before Calling for Service .....	30-32
<b>WARRANTY</b> .....	33

## PRODUCT RECORD

In the space below, record the date of purchase, model, and serial number of your product. You will find the model and serial number printed on an identification plate located inside the washer door. Have these items of information available whenever you contact Sears concerning your product.

Model No. \_\_\_\_\_

Date of Purchase \_\_\_\_\_

Serial No. \_\_\_\_\_

Save these instructions and your sales receipt for future reference.

## SAFETY MESSAGES

There are many important safety messages in this manual and on your appliance. Always read and obey all safety messages.



This is the safety alert symbol. This symbol alerts you to potential hazards that can result in property damage and/or serious bodily harm or death.

All safety messages will follow the safety alert symbol and the word WARNING.  
This word means:

### WARNING

Indicates a hazardous situation which, if not avoided, could result in death or serious injury.

All safety messages will tell you what the potential hazard is, tell you how to reduce the chance of injury, and tell you what can happen if the instructions are not followed.

## IMPORTANT SAFETY INSTRUCTIONS

### WARNING

**To reduce the risk of fire, electric shock, or injury to persons when using this appliance, follow basic precautions, including the following.**

- Before use, the washer must be properly installed as described in this manual.
- Do not wash articles that have been previously cleaned in, washed in, soaked in, or spotted with gasoline, dry cleaning solvents, or other flammable or explosive substances, as they give off vapors that could ignite or explode.
- Do not add gasoline, dry cleaning solvents, or other flammable or explosive substances to the wash water. These substances give off vapors that could ignite or explode.
- Under certain conditions, hydrogen gas may be produced in a hot water system that has not been used for two weeks or more. **HYDROGEN GAS IS EXPLOSIVE.** If the hot water system has not been used for such a period, before using the washer, turn ON all hot water faucets and let the water flow from each for several minutes. This will release any accumulated hydrogen gas. As the gas is flammable, do not smoke or use an open flame during this time.
- Do not allow children to play on or in the washer. Close supervision of children is necessary when the washer is used near children.
- Before the washer is removed from service or discarded, remove the door to prevent children from climbing inside.
- Do not install or store the washer where it will be exposed to the weather or freezing temperatures.
- Do not tamper with controls.
- Do not repair or replace any part of the washer or attempt any servicing other than as described in this manual. We strongly recommend that any service be performed by a qualified technician.
- See Installation Instructions for grounding requirements.
- ALWAYS follow the fabric care instructions supplied by the garment manufacturer.
- Do not place items exposed to cooking oil in your washer. Items contaminated with cooking oils may contribute to a chemical reaction that could cause a load to catch fire.
- Use fabric softeners or products to eliminate static only as recommended by the manufacturer.
- This washer is not designed for maritime use or for mobile installations such as in RVs, aircraft, etc.
- Turn OFF the water faucets and unplug the washer if the machine is to be left for an extended period of time, such as during vacations.
- Packaging material can be dangerous for children. **There is a risk of suffocation.** Keep all packaging from children.
- Always check the inside of the washer for foreign objects before loading laundry. Keep the door closed when not in use.

### **⚠ WARNING**

To reduce the risk of fire, electric shock, or injury to persons when using this appliance, follow basic precautions, including the following.

- **Unplug the washer before cleaning** to avoid the risk of electric shock.
- **Never use harsh chemicals, abrasive cleaners, or solvents to clean the washer.** They will damage the finish.
- **Do not put oily or greasy rags or clothing on top of the washer.** These substances give off vapors that could ignite the materials.
- **Do not wash items that are soiled with vegetable or cooking oil.** These items may contain some oil after laundering and may catch fire.
- **Disconnect this appliance from the power supply before attempting any user maintenance.** Turning the controls to the OFF position does not disconnect this

appliance from the power supply. Failure to follow this warning can cause serious injury, fire, electric shock, or death.

- **Do not combine detergents, fabric softeners, and/or other laundry products from different manufacturers for use in a load, unless specified on the fabric label.**
- **Do not mix chlorine bleach with ammonia or acids such as vinegar.** Follow package directions when using laundry products. Incorrect usage can produce poisonous gas, resulting in serious injury or death.
- **Do not reach into the washer while parts are moving. Before loading, unloading, or adding items, push in the cycle selector knob and allow the drum to coast to a complete stop before reaching inside.** Failure to follow this warning can cause serious injury, fire, electric shock or death.

### **⚠ WARNING**

- **Refer to INSTALLATION INSTRUCTIONS for detailed grounding procedures.** Installation instructions are packed in the washer for the installer's reference. If the washer is moved to a new location, have it checked and reinstalled by a qualified service technician. Failure to follow this warning can cause serious injury, fire, electric shock, or death.
- **Do not, under any circumstances, cut or remove the third (ground) prong from the power cord.** Failure to follow this warning can cause serious injury, fire, electric shock, or death.
- **For personal safety, this appliance must be properly grounded.** Failure to follow this warning can cause serious injury, fire, electric shock, or death.
- **The power cord of this appliance is equipped with a 3-prong (grounding) plug which mates with a standard 3-prong (grounding) wall outlet** to minimize the possibility of electric shock hazard from this appliance.
- **This washer must be plugged into a 120VAC, 60Hz grounded outlet.** Failure to follow this warning can cause serious injury, fire, electric shock, or death.
- **Have the wall outlet and circuit checked by a qualified electrician to make sure the outlet is properly grounded.** Failure to follow this warning can cause serious injury, fire, electric shock, or death.
- **Where a standard 2-prong wall outlet is encountered, it is your personal responsibility and obligation to have it replaced with a properly grounded 3-prong wall outlet.** Failure to follow this warning can cause serious injury, fire, electric shock, or death.
- **Do not install on carpet. Install the washer on a solid floor.** Failure to follow this warning can cause serious leak damage.
- **Do not remove grounding prong. Do not use an adapter or extension cord. Plug into a grounded 3-prong outlet.** Failure to follow these warnings can cause serious injury, fire, electric shock, or death.

- **The washer should always be plugged into its own individual electrical outlet which has a voltage rating that matches the rating plate.** This provides the best performance and also prevents overloading house wiring circuits which could cause a fire hazard from overheated wires.
- **Never unplug your washer by pulling on the power cord.** Always grip plug firmly and pull straight out from the outlet. Failure to follow this warning can cause serious injury, fire, electric shock, or death.
- **Immediately repair or replace all power cords that have become frayed or otherwise damaged. Do not use a cord that shows cracks or abrasion damage along its length or at either end.** Consult with a qualified service technician. Failure to follow this warning can cause serious injury, fire, electric shock, or death.
- **When installing or moving the washer, be careful not to pinch, crush, or damage the power cord.** Failure to follow this warning can cause serious injury, fire, electric shock, or death.
- **The washer must be installed and electrically grounded by a qualified service technician in accordance with local codes** to prevent shock hazard and assure stability during operation.
- **The washer is heavy. Two or more people may be needed to install and move the appliance.** Failure to do so can result in damage to property or serious bodily injury.
- **Store and install the washer where it will not be exposed to temperatures below freezing or exposed to outdoor weather conditions.** Failure to follow this warning can cause serious leak damage.
- **To reduce the risk of electric shock, do not install the washer in humid spaces.** Failure to follow this warning can cause serious injury, fire, electric shock, or death.

**⚠ WARNING: RISK TO CHILDREN**

- Do not allow children to play on or in the washer. Close supervision of children is necessary when the washer is used near children. As children grow, teach them the proper, safe use of all appliances. Failure to comply with these warnings could result in serious personal injury.
- Destroy the carton, plastic bag, and other packing materials after the washer is unpacked. Children might use them for play. Cartons covered with rugs, bedspreads, or plastic sheets can become airtight chambers. Failure to comply with these warnings could result in serious personal injury
- Keep laundry products out of children's reach. To prevent personal injury, observe all warnings on product labels. Failure to comply with these warnings could result in serious personal injury.
- Before your washer is removed from service or discarded, remove the door to the washing compartment to avoid the danger of children or small animals getting trapped inside. Failure to do so can result in serious personal injury or death.

**GROUNDING REQUIREMENTS**

**IMPORTANT: Please read carefully. TO CONNECT ELECTRICITY**

**⚠ WARNING**

Improper connection of the equipment-grounding conductor can result in risk of electric shock. Check with a qualified electrician or service technician if you are in doubt as to whether the appliance is properly grounded. Do not modify the plug provided with the appliance. If it does not fit the outlet, have a proper outlet installed by a qualified electrician. Failure to follow these warnings can cause serious injury, fire, electric shock, or death.

**GROUNDING INSTRUCTIONS**

This appliance must be grounded. In the event of malfunction or breakdown, grounding will reduce the risk of electric shock by providing a path of least resistance for electric current. This appliance is equipped with a cord having an equipment-grounding conductor and grounding plug. The plug must be plugged into an appropriate outlet that is properly installed and grounded in accordance with all local codes and ordinances.

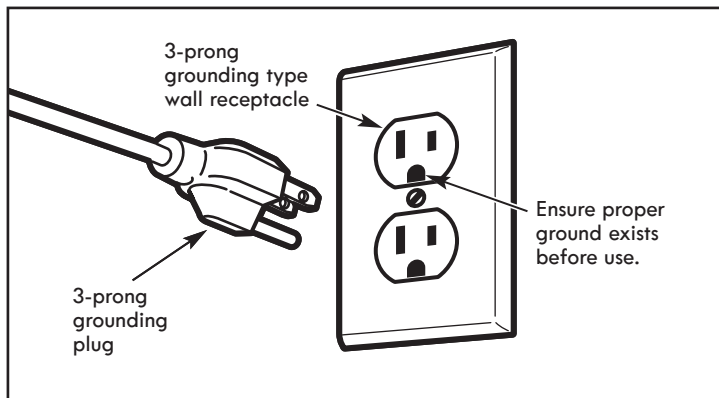

KEY PARTS AND COMPONENTS

- A DETERGENT DISPENSER**  
There are four compartments. One each for prewash, main wash, liquid bleach, and liquid fabric softener.
- B CONTROL PANEL WITH LED DISPLAY**  
The easy-to-read LED display shows cycle options, settings, cycle status, and estimated time remaining during operation.  
**NOTE:** Sensors in the washer automatically detect the size of the wash load to optimize washing time, based on the selected cycle and options.
- C DIRECT-DRIVE MOTOR**  
The direct-drive motor provides improved performance and reliability while increasing energy efficiency. (Motor is not visible.)
- D LARGE-CAPACITY STAINLESS STEEL DRUM**  
The ultra-large stainless steel drum offers extreme durability and is tilted to improve efficiency and allow easier access for large items.
- E EASY-ACCESS LOCKING DOOR**  
The extra-large door locks during operation. The door will not open until it is safe to do so.
- F FILTER ACCESS PANEL**  
Provides easy access to the drain pump filter, which allows you to clean the filter or retrieve lost items without a service call.
- G LEVELING FEET**  
Four leveling feet (two in the front and two in the back) adjust to improve washer stability on uneven floors. Feet are adjusted and locked in place using the adjusting wrench included with the washer.
- H HIGH-EFFICIENCY STEAM CYCLES**  
During high-efficiency steam cycles, hot steam interacts with fabrics to help remove tough stains.
- I DOOR MAGNET**  
Safely and conveniently keeps the door ajar. There are two door closed positions, fully closed and slightly ajar. In the latter position, the door is only closed to the door magnet to keep the door slightly open when the washer is not in use. This will promote air circulation and allow the interior of the machine to dry. To use this feature, close the door just until it contacts the door magnet.

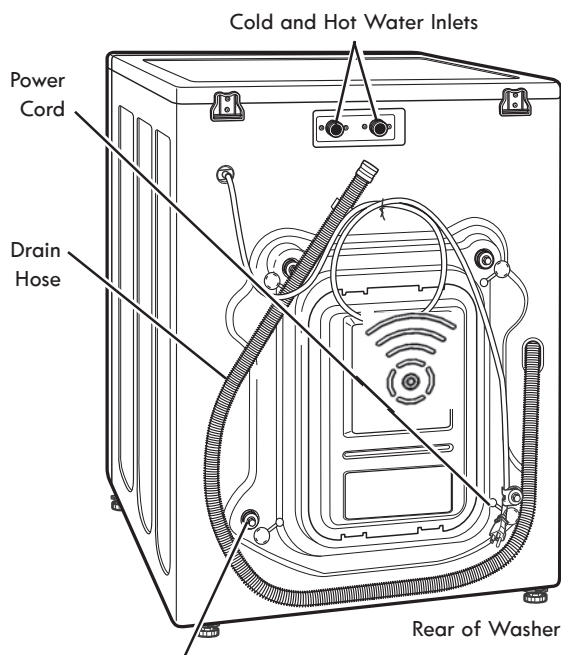
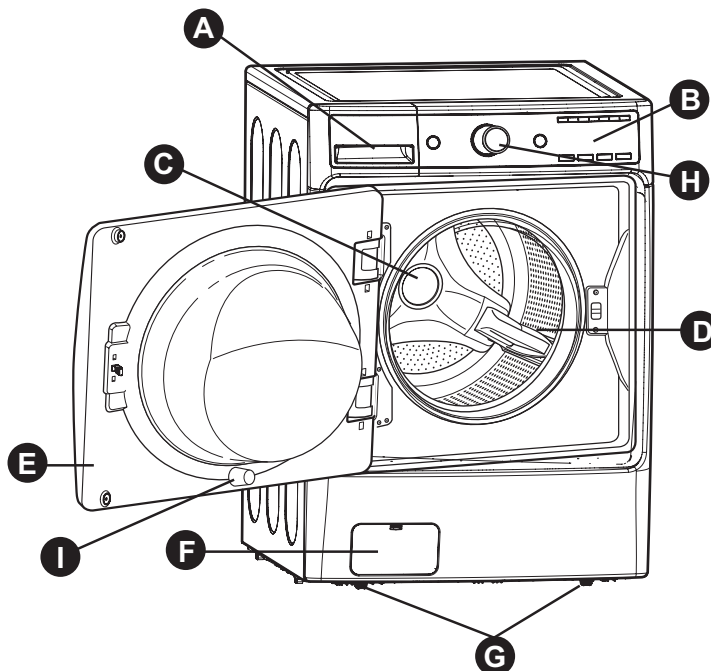

Shipping Bolts/Retainers (4)  
**NOTE: Bolts/Retainers MUST be removed prior to operation. Keep for future use.**

Included Accessories

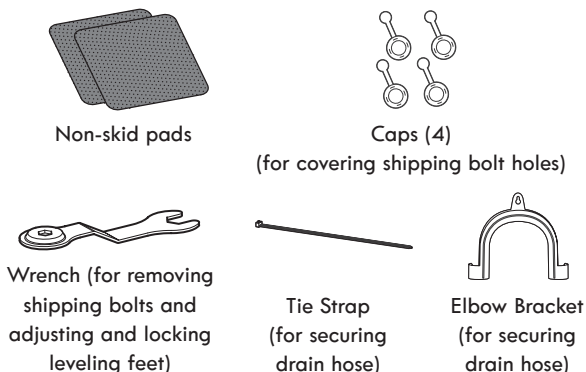

Optional Accessories

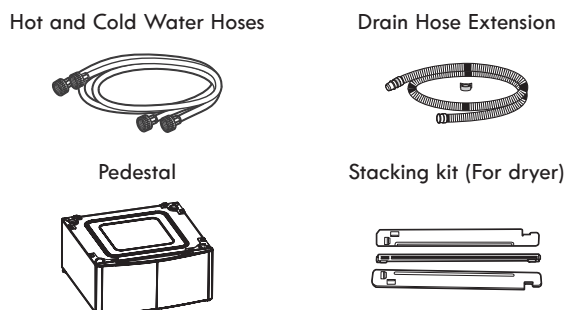

Wrench appearance may vary.

# INSTALLATION REQUIREMENTS

## KEY DIMENSIONS AND SPECIFICATIONS

Description	Front-Loading Washer
Electrical Requirements	120 VAC, 60 Hz
Max. Water Pressure	20 - 120 psi (138 - 827 kPa)
Dimensions	27"(W) X 30 1/4"(D) X 39"(H), 55" (D with door open) 70 cm(W) X 77 cm(D) X 99 cm(H), 139.6 cm (D with door open)
Net Weight	220 lbs (100 kg)
Max. Spin Speed	1,300 RPM

## CHOOSE THE PROPER LOCATION

### WARNING

- This washer is heavy. Two or more people are required when moving and unpacking the washer. Failure to do so may result in damage to property or serious bodily harm.
- Store and install the washer where it will not be exposed to temperatures below freezing or exposed to outdoor weather conditions. Failure to follow this warning can cause serious injury, fire, electric shock, or death.
- Properly ground the washer to conform with all electric governing codes and ordinances. Failure to follow this warning can cause serious injury, fire, electric shock, or death.
- To reduce the risk of electric shock, do not install the washer in humid spaces. Failure to follow this warning can cause serious injury, fire, electric shock, or death.
- To ensure proper air flow, do not block the large opening on the bottom of the washer with carpeting or other materials.
- Do not remove ground prong. Do not use an adapter or extension cord. Plug into a grounded 3-prong outlet. Failure to follow this warning can cause serious injury, fire, electric shock, or death.
- Certain internal parts are intentionally not grounded and may present a risk of electric shock only during servicing. Service personnel - Do not contact the following parts while the appliance is energized: pump, valve, motor, control board.

**NOTE:** Installing the washer in a humid space, or installing or storing the washer where it will be exposed to the weather or freezing temperatures, may result in rust or other damage that is not covered by the product warranty.

### Power Outlet

- The power outlet must be within 60 in. (1.5 m) of either side of the washer.
- The appliance and outlet must be positioned so that the plug is easily accessible.
- Do not overload the outlet with more than one appliance.
- The outlet must be grounded in accordance with current wiring electric codes and regulations.
- Time-delay fuse or circuit breaker is recommended.

**NOTE:** It is the personal responsibility and obligation of the product owner to have a proper outlet installed by a qualified service technician.

## FLOORING

- To minimize noise and vibration, the washer MUST be installed on a solidly constructed floor. See the NOTE at right.
- Allowable slope under the entire washer is a maximum 1 in. difference from side to side or from front to back.
- Installing on carpeting and soft tile surfaces is not recommended.
- Never install the washer on a platform or weakly supported structure.

## CLEARANCES

Allow at least 24 3/4 in. (62.6 cm) in front of the washer to open the door.

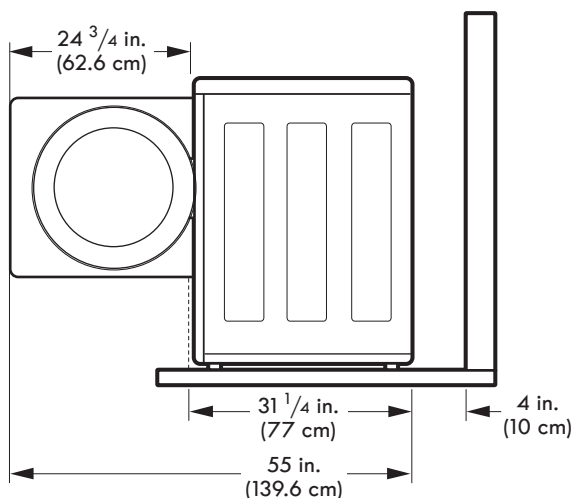

To ensure sufficient clearance for water lines and airflow, allow minimum clearances of at least 1 in. (2.5 cm) at the sides and 4 in. (10 cm) behind the unit. Be sure to allow for wall, door, or floor moldings that may increase the required clearances.

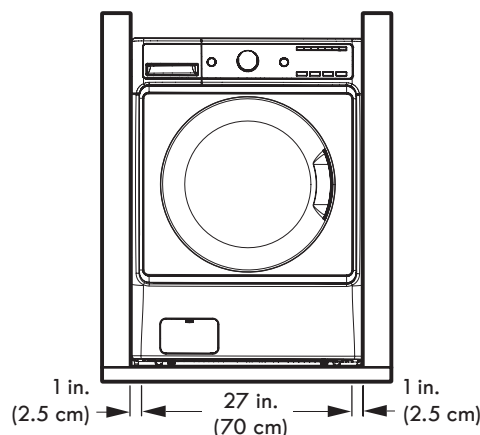

**NOTE:** The floor must be strong and rigid enough to support the weight of the washer, when fully loaded, without flexing or bouncing. If your floor has too much flex, reinforce it to make it more rigid. A floor that is adequate for a top-loading washer may not be rigid enough for a front loading washer, due to the difference in the spin speed and direction. If the floor is not solid, your washer may vibrate and you may hear and feel the vibration throughout your house.

## UNPACKING AND REMOVING SHIPPING BOLTS

When removing the washer from the carton base, be sure to remove the foam drum support in the middle of the carton base. See drawing below.

If you must lay the washer down to remove the base packaging materials, always protect the side of the washer and lay it carefully on its side. **DO NOT** lay the washer on its front or back.

To prevent internal damage during transport, the washer is equipped with four shipping bolts and plastic retainers.

### IMPORTANT:

- These shipping bolts and retainers **MUST NOT** be removed until just before moving the washer into its final position.
- These bolts and retainers **MUST** be removed before operating the washer.
- Failure to remove shipping bolts and retainers may cause severe vibration and noise, which can lead to permanent damage to the washer.

**NOTE:** The power cord is secured to the back of the washer with a shipping bolt to help prevent operation with shipping bolts in place.

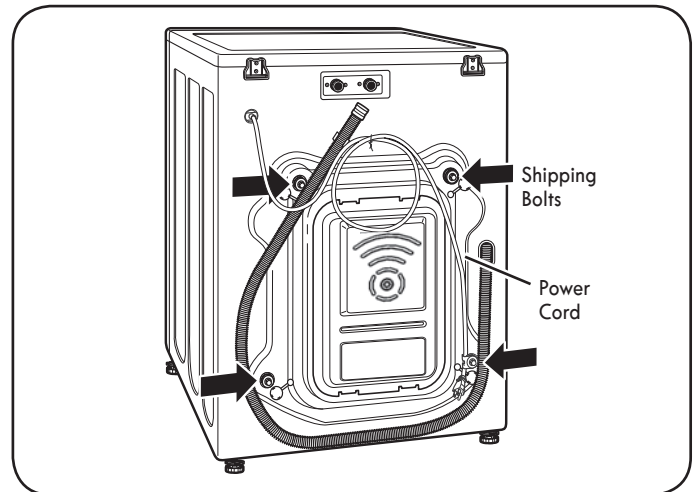
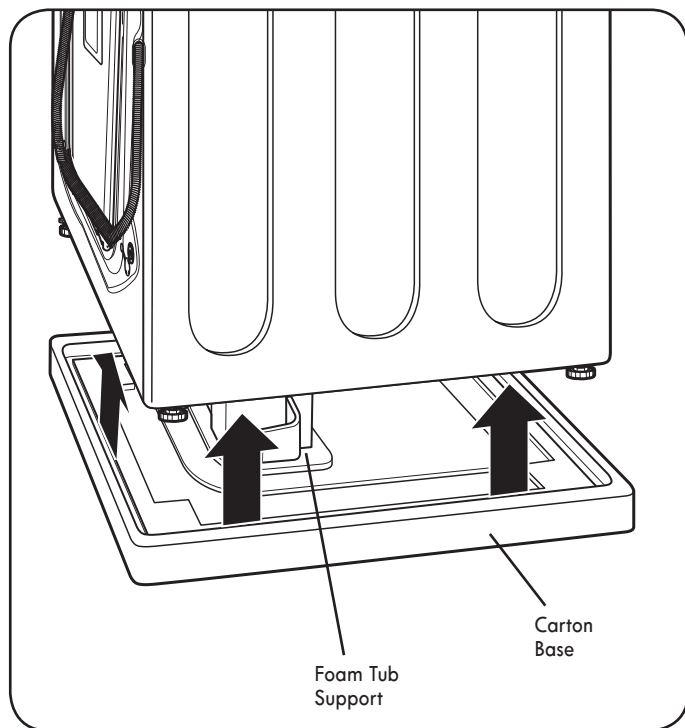

1. Starting with the bottom two shipping bolts, use the wrench (included) to fully loosen all four shipping bolts by turning them counterclockwise.

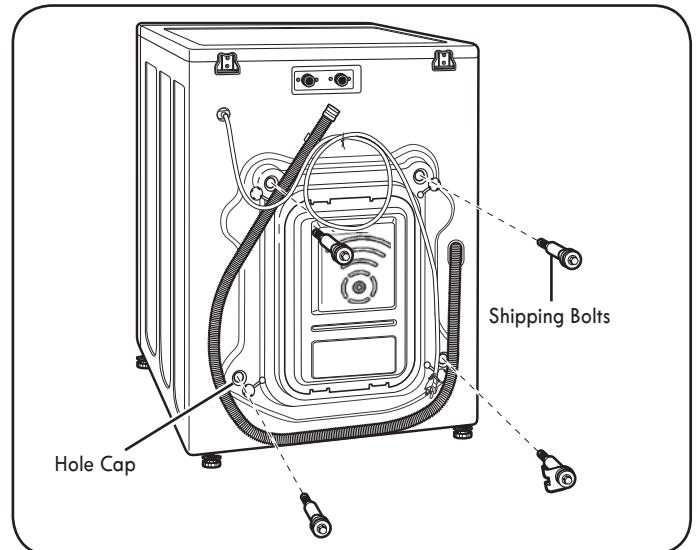

2. Remove the bolt assemblies by wiggling them slightly while pulling.
3. Locate the four hole caps included in the accessory pack and install them in the shipping bolt holes.

**NOTE:** Save the bolt assemblies for future use. To prevent damage to internal components, **DO NOT** transport the washer without reinstalling the shipping bolts.



## CONNECTING THE WATER LINES

- **IMPORTANT:** Use new hoses when installing the washer. Do NOT reuse old hoses.
- **IMPORTANT:** ONLY use new, high-quality inlet hoses when installing this laundry product. Aftermarket hoses are not guaranteed to fit or function correctly. Other hoses may not tighten correctly and could cause leaks. Subsequent damage to product or property will not be covered under the terms of the product warranty.
- Water supply pressure must be between 20 psi and 120 psi (138 - 827 kPa). If the water supply pressure is more than 120 psi, a pressure reducing valve must be installed.
- Periodically check the hose for cracks, leaks, and wear, and replace the hose if necessary.
- Make sure that the water lines are not stretched, pinched, crushed, or kinked.
- The washer should never be installed or stored in a location subject to freezing temperatures. Damage to the water lines and internal mechanisms of the washer can result. If the washer was exposed to freezing temperatures prior to installation, allow it to stand at room temperature for several hours before use and check for leaks prior to operation.

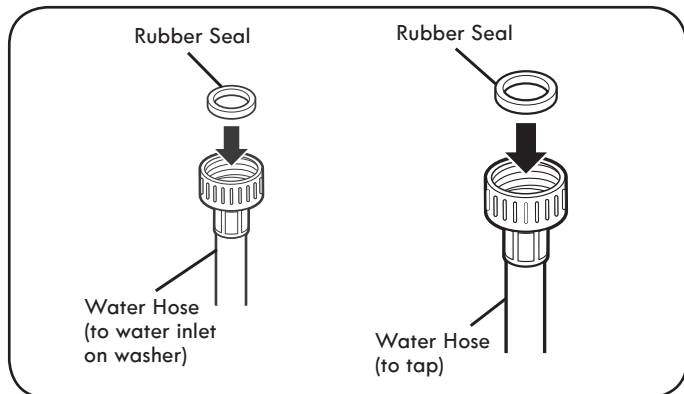

1. Inspect the threaded fitting on each hose and make sure there is a rubber seal in place in both ends.

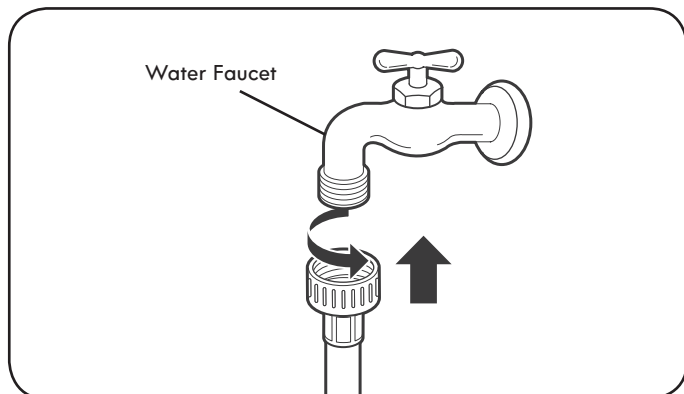

2. Connect the water supply hoses to the HOT and COLD water faucets tightly by hand and then tighten another  $\frac{2}{3}$  turn with pliers.

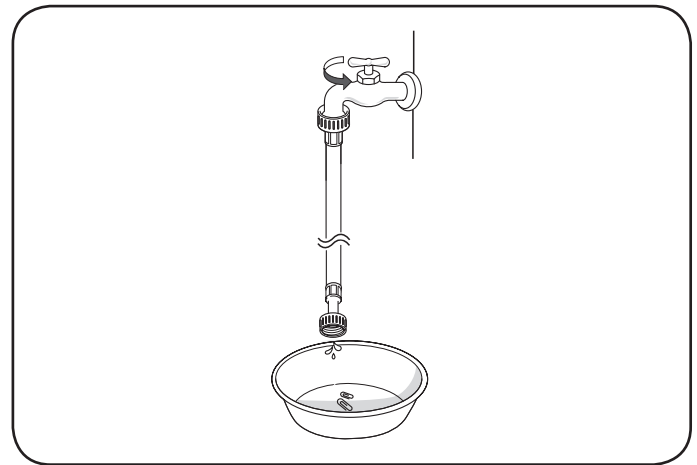

3. Always run a gallon or two (4L) of water through each inlet hose to flush dirt, scale and other debris out of the water lines. Doing so will help prevent future problems with clogged filter screens, and will also allow you to verify which hose is hot and which is cold.

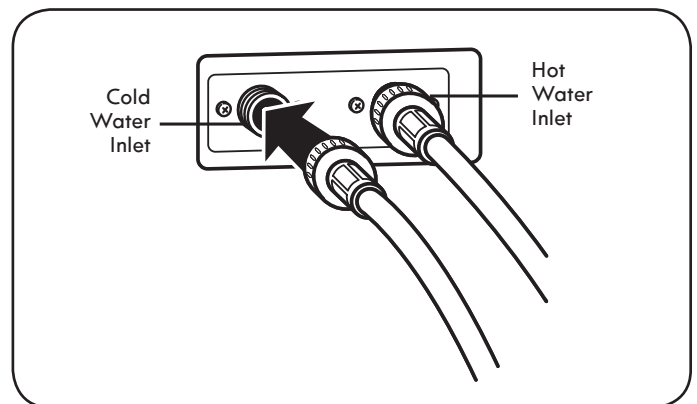

4. Attach the (red) hot water line to the hot water inlet on the back of the washer. Attach the (blue) cold water line to the cold water inlet on the back of the washer. Tighten the fittings securely.

**NOTE:** When installing the hoses onto the water inlet valves, be careful not to cross-thread the hose fittings. DO NOT overtighten the hoses; this could cause damage to internal components, the valve or the hose gasket. Overtightening could result in property damage from leaks.

## CONNECTING THE DRAIN HOSE

- The drain hose should always be properly secured. Failure to properly secure the drain hose can result in flooding and property damage.
- Do not install the end of the drain hose lower than 29 in. (73.7 cm) or higher than 96 in. (243.8 cm) above the bottom of the washer.
- The drain must be installed in accordance with any applicable local codes and regulations.
- Make sure that the drain hose is not stretched, pinched, crushed, or kinked.

### NOTE:

A drain hose extension kit is available if the drain hose is not long enough. Do not extend the drain hose more than 6 feet, as this will cause poor draining, which will result in poor wash and spin performance.

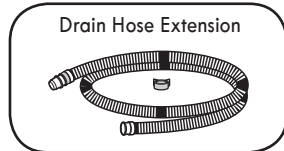

### Option 1: Standpipe

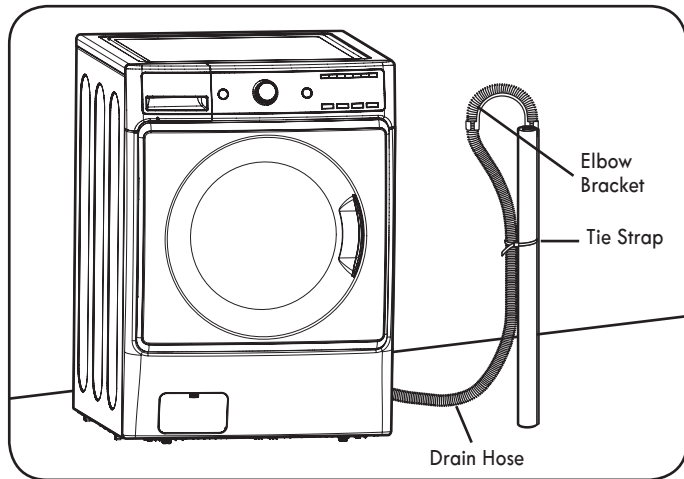

Install the end of the drain hose into the elbow bracket. Do not extend the drain hose more than 4 inches (10 cm) past the end of the elbow bracket. Use a tie strap to secure the drain hose in place.

### NOTE:

- Total height of the hose end should not exceed 96 in. (243.8 cm) from the bottom of the washer.
- The drain hose should be inserted no more than 8–12 inches into the standpipe. Inserting more than 8–12 inches (20–30 cm) can cause mold or microorganisms to spread to the inside of the washer.

If the water valves and drain are built into the wall, fasten the drain hose to one of the water hoses with the tie strap.

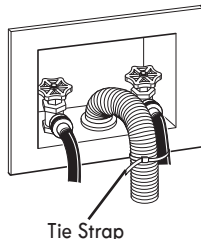

### Option 2: Laundry Tub

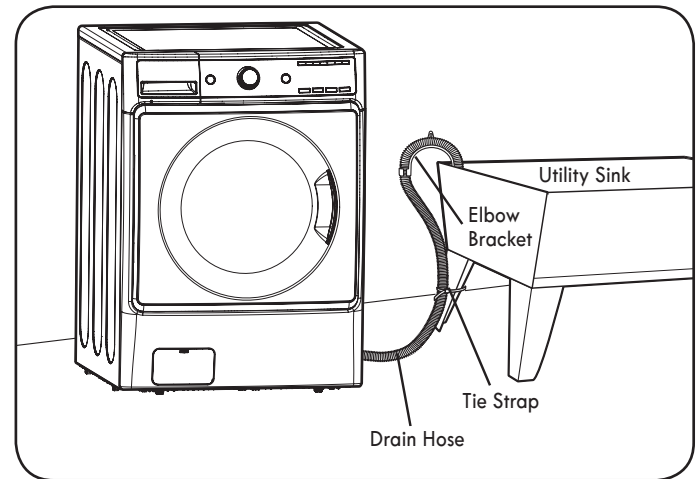

Install the elbow bracket near the end of the drain hose. Hang the end of the drain hose over the side of the utility sink. Use a tie strap to secure the drain hose in place.

## CONNECTING TO THE POWER SUPPLY

Washer should be plugged into a 120-VAC, 60-Hz grounded 3-prong outlet. Plug in the washer.

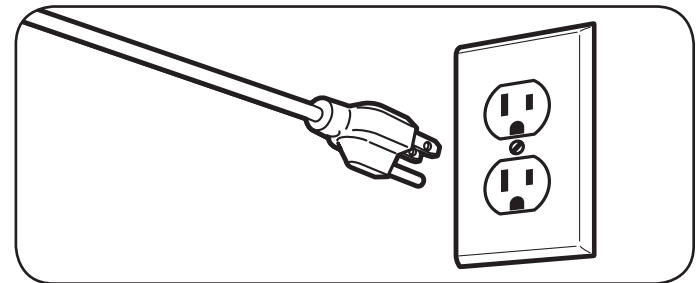

## LEVELING THE WASHER

The drum of your new washer spins at very high speeds. To minimize vibration, noise, and unwanted movement, the floor must be a level, solid surface.

**NOTE:** Adjust the leveling feet only as far as necessary to level the washer. Extending the leveling feet more than necessary can cause the washer to vibrate.

**NOTE:** Before installing the washer, make sure that the floor is clean, dry and free of dust, dirt, water and oils so the washer feet cannot slide easily. Leveling feet that move or slide on the floor can contribute to excess vibration and noise due to poor contact with the floor. See **INSTALLATION OF NON-SKID PADS** for more information.

**NOTE:** If a drip pan must be used, make sure to follow the instructions provided with the drip pan and make sure the leveling feet are adjusted for firm and even contact with the pan. Use of drip pans and failure to properly level the machine may result in increased vibration and noise during operation.

All four leveling feet must rest solidly on the floor. Rock the washer from corner to corner to make sure that all four leveling feet are in firm and even contact with the floor.

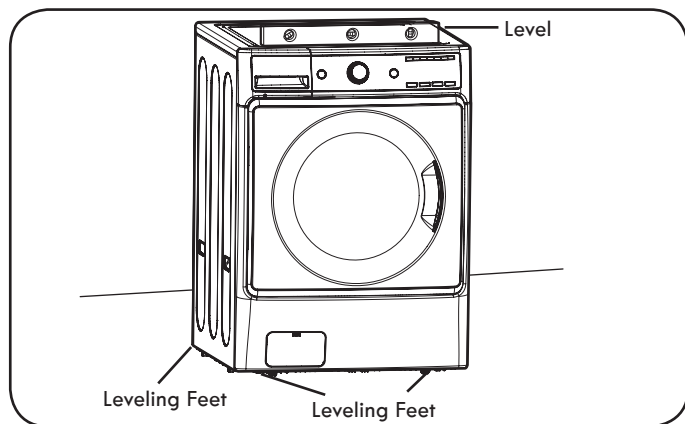

1. Position the washer in its final location, taking special care not to pinch, strain, or crush the water and drain lines. Place a level across the top of the washer.

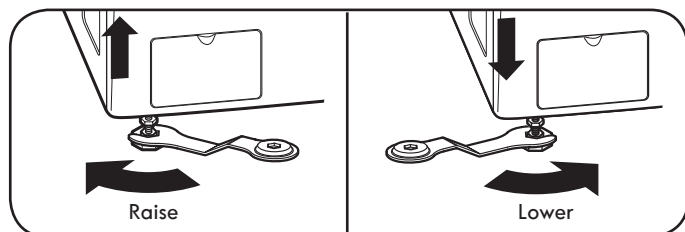

2. Loosen the locknuts on all four leveling feet with the wrench until you can adjust the feet (wrench appearance may vary). Use the wrench to turn the feet clockwise to raise the washer, and counterclockwise to lower the washer. Using a level, adjust the feet until the washer is level from side to side and front to back. Make sure that all four feet are in firm contact with the floor.

**NOTE:** If you are installing the washer on the optional pedestal, the washer leveling feet should be fully retracted. Use the leveling feet on the pedestal to level the washer.

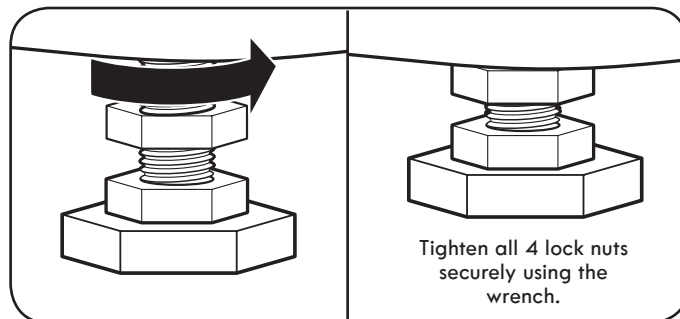

3. Once the washer is level from side to side and front to back, use the adjusting wrench to tighten all four lock nuts securely to prevent the legs from getting out of adjustment during operation. Make sure that all four leveling feet are in firm contact with the floor.

**NOTE:** To make sure that the washer is properly level, run the washer with a test load: place a medium-sized load of laundry in the machine. Then, press **POWER**, select **RINSE & SPIN**, and press the **START/PAUSE** button.

See the following sections for additional information on cycle selection and operation. Verify that the washer does not rock or vibrate excessively during the spin cycle. If the washer vibrates or shakes, adjust the leveling feet, while the washer is spinning, until the vibrations are reduced.

## INSTALLATION OF NON-SKID PADS (optional)

Some floor surfaces are too slippery to prevent the washer from moving on the floor during heavily unbalanced loads. While it is normal for an occasional load to be out of balance, excess noise and vibration can result from the washer moving out of position. If these conditions are encountered, follow the instructions below for installation of the non-skid pads. These pads will help prevent the washer from moving during heavy, out of balance conditions, thereby reducing noise and vibration.

**NOTE:** Non-skid pads are included in the installation packet.

### Non-skid pads

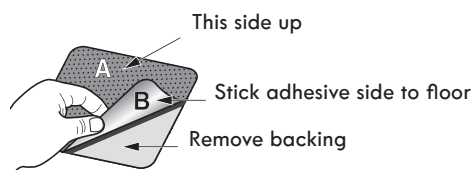

- \* Place the pads under both front feet.

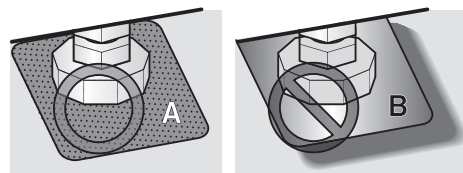

**WARNING:** To reduce the risk of fire, electric shock, or injury to persons, read and follow this entire Use & Care Guide, including the Important Safety Instructions, before operating this washer.

## CONTROL PANEL FEATURES

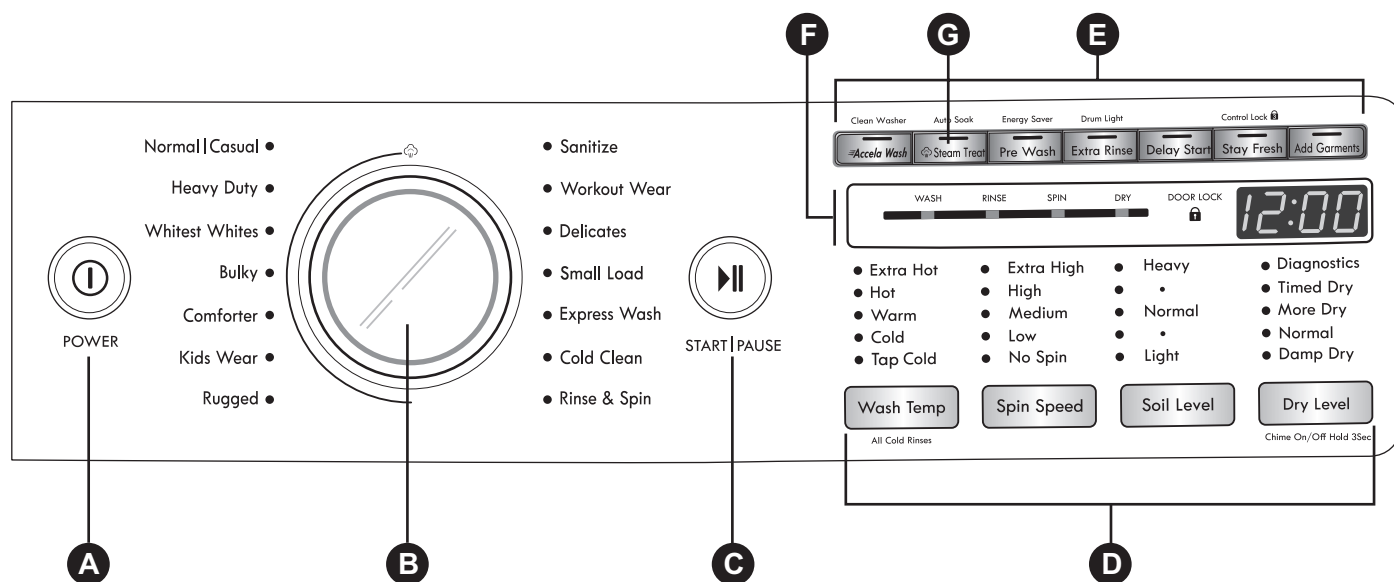

### A POWER (ON/OFF) BUTTON

Press to turn the washer ON or OFF.

**NOTE:** Pressing the POWER button during a cycle will cancel that cycle and any load settings will be lost. The door will unlock after a brief pause, unless the water level or temperature is too high.

### B CYCLE SELECTOR KNOB

Turn this knob to select the desired cycle. Once the desired cycle has been selected, the standard presets will appear in the display. These settings can be adjusted using the cycle setting buttons any time before starting the cycle.

### C START/PAUSE BUTTON

Press this button to start the selected cycle. If the washer is running, use this button to pause the cycle without losing the current settings.

**NOTE:** If you do not press the START/PAUSE button within one hour of selecting a cycle, the washer automatically turns OFF.

### D CYCLE MODIFIER BUTTONS

Use these buttons to adjust the settings for the selected cycle. The settings light up above the buttons to show the current selection.

### E SPECIAL CYCLE AND OPTION BUTTONS

These buttons are used to activate special cycles or options.

### F TIME AND STATUS DISPLAY

The display shows the cycle status, door lock status and estimated time remaining.

### G STEAM TREAT BUTTON

Select the STEAM TREAT button to add steam to the selected cycle for added cleaning power.

**NOTE:** The steam option is not available on all cycles.

**NOTE:** To protect your clothing, not all settings are available on all cycle selections.

## OPERATING THE WASHER



### 1 SORT LAUNDRY AND LOAD WASHER

Sort laundry by fabric type, soil level, color and load size, as needed. Open the door and load selected items into the washer.

### 2 TURN ON THE WASHER

Press the POWER button to turn ON the washer. The lights around the cycle selector knob will illuminate and a chime will sound.

- Normal | Casual
- Heavy Duty
- Whitest Whites
- Bulky
- Comforter
- Kids Wear
- Rugged

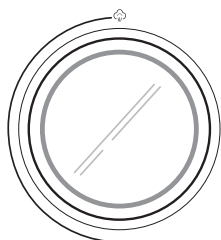

- Sanitize
- Workout Wear
- Delicates
- Small Load
- Express Wash
- Cold Clean
- Rinse & Spin

### 3 SELECT A CYCLE

Turn the cycle selector knob in either direction to select the desired cycle. The preset Wash Temperature, Spin Speed, Soil Level, and Option settings for that cycle will be shown.

- |             |              |          |               |
|-------------|--------------|----------|---------------|
| • Extra Hot | • Extra High | • Heavy  | • Diagnostics |
| • Hot       | • High       | • •      | • Timed Dry   |
| • Warm      | • Medium     | • Normal | • More Dry    |
| • Cold      | • Low        | • •      | • Normal      |
| • Tap Cold  | • No Spin    | • Light  | • Damp Dry    |

### 4 SELECT CYCLE MODIFIERS

Default settings for the selected cycle can now be changed if desired. Use the cycle modifier buttons.

**NOTE:** To protect your fabrics, not all modifiers are available on all cycles.

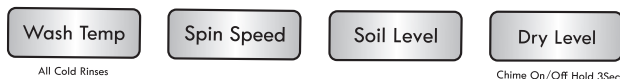

All Cold Rinses

Chime On/Off Hold 3Sec

### 5 SELECT CYCLE OPTIONS

Cycle options can be added using the option buttons.

**NOTE:**

- Not all options are available on all cycles. A different chime will sound and the LED will not come on if the selection is not allowed.

### 6 ADD DETERGENT

Add High-Efficiency (HE) detergent to the detergent dispenser drawer. For proper wash performance, always measure the detergent using the measuring device provided by the detergent manufacturer.



































































### 7 BEGIN CYCLE

Press the START/PAUSE button to begin the cycle. The door will lock, the washer will briefly tumble the load without water to measure its weight, and then the washer will begin the selected wash cycle.

Pressing the START/PAUSE button will pause the cycle and the door will unlock. Press the START/PAUSE button again to resume the wash cycle.

**CYCLE GUIDE**

The cycle guide below shows the default settings, available options and recommended fabric types for each cycle. Allowable modifier adjustments are shown below the default setting for each cycle.  = Available Option  = Default Setting

Cycle	Fabric or Load Type	Load Sensing	Wash Option	Wash Temp.	Spin Speed	Soil Level	Accela Wash	Steam Treat	Pre Wash	Extra Rinse	Delay Start	Stay Fresh	Auto Soak	Energy Saver	Dry	
Normal/ Casual	Cotton, linen, towels, shirts, sheets, jeans, mixed loads.	Yes	Yes	Warm	High	Normal										
				Extra Hot	Extra High	Heavy										
				Hot	Medium	Light										
Heavy Duty	Heavily soiled cotton fabrics.	Yes	Yes	Warm	Extra High	Heavy										
				Extra Hot	High	Normal										
				Hot	Medium	Light										
Whitest Whites	Heavily to normally soiled white cottons.	Yes	Yes	Hot	High	Normal										
				Warm	Extra High	Heavy										
				Cold	Medium	Light										
Bulky	Large items such as blankets and comforters.	No	Yes	Warm	Medium	Normal										
				Hot	Low	Heavy										
				Cold	No Spin	Light										
Comforter	Comforters, blankets, rugs.	No	Yes	Warm	High	Normal										
				Hot	Medium	Heavy										
				Cold	Low	Light										
Kids Wear	Specially designed to clean and thoroughly rinse kids wear.	Yes	Yes	Hot	High	Heavy										
				Warm	Extra High	Normal										
				Cold	Medium	Light										
Rugged	Heavily soiled hard and thick items such as jeans and construction work wear.	Yes	Yes	N/A	High	N/A										
					Extra High											

**\*CERTIFIED BY NSF:** NSF International (formerly the National Sanitation Foundation), certifies that this wash cycle reduces 99.9% of bacteria on laundry through high temperature, when used with powdered detergent.

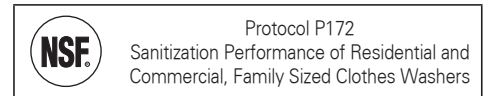

**NOTE:**

- To protect your garments, not every wash temperature, spin speed, soil level, or option is available with every cycle. A chime will sound and the LED will not light if the selection is not allowed.
- The washer automatically adjusts the wash time for the amount of laundry, water pressure, water heating time and other operating conditions.
- These cycles use various wash motions to enhance cleaning and/or fabric care performance. The wash motions may sound different at different stages of the wash cycle. This is normal.
- The recommended load size for the Sanitize cycle is 10 lb. (4.5 kg).
- When the Accela Wash option is selected, the drum spins to rinse the clothes. To use the No Spin option, you must deselect the Accela Wash option.

**CYCLE GUIDE (continued)**

The cycle guide below shows the default settings, available options and recommended fabric types for each cycle. Allowable modifier adjustments are shown below the default setting for each cycle. ● = Available Option □ = Default Setting

Cycle	Fabric or Load Type	Load Sensing	Wash Option	Wash Temp.	Spin Speed	Soil Level	Accela Wash	Steam Treat	Pre Wash	Extra Rinse	Delay Start	Stay Fresh	Auto Soak	Energy Saver	Dry
Sanitize*	Heavily soiled items such as work clothes, diapers, etc.	Yes	Yes	Extra Hot	High	Normal	●	●	●	●	●	●	●	●	●
					Extra High Medium Low No Spin	Heavy Light									
Workout Wear	Permanent press, synthetic items.	No	Yes	Warm	Medium	Normal				●	●	●	●		
				Cold Tap Cold	Low No Spin	Heavy Light									
Delicates	Dress shirts, blouses, nylons, sheer or lacy garments.	No	Yes	Cold	Medium	Normal			●	●	●	●	●		
				Warm Tap Cold	Low No Spin	Heavy Light									
Small Load	Normally soiled and small loads.	Yes	Yes	Warm	High	Normal			●	●	●	●			●
				Hot Cold Tap Cold	Extra High Medium Low No Spin	Heavy Light									
Express Wash	Lightly soiled clothing and small loads.	No	Yes	Hot	Extra High	Light	●			●	●	●	●		
				Warm Cold Tap Cold	High Medium Low No Spin	Normal Heavy									
Cold Clean	Small loads of cotton, linen, towels, shirts, sheets, jeans, mixed loads.	Yes	Yes	Cold	High	Normal			●	●	●	●	●		●
				Tap Cold	Extra High Medium Low No Spin	Light									
Rinse & Spin	Loads that only need to be rinsed.	No	No	Cold	High	N/A				●	●	●			●
					Extra High Medium Low No Spin										

\***CERTIFIED BY NSF:** NSF International (formerly the National Sanitation Foundation), certifies that this wash cycle reduces 99.9% of bacteria on laundry through high temperature, when used with powdered detergent.

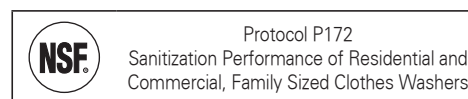













**NOTE:**

- To protect your garments, not every wash temperature, spin speed, soil level, or option is available with every cycle. A chime will sound and the LED will not light if the selection is not allowed.
- The washer automatically adjusts the wash time for the amount of laundry, water pressure, water heating time and other operating conditions.
- These cycles use various wash motions to enhance cleaning and/or fabric care performance. The wash motions may sound different at different stages of the wash cycle. This is normal.
- The recommended load size for the Sanitize cycle is 10 lb. (4.5 kg).
- When the Accela Wash option is selected, the drum spins to rinse the clothes. To use the No Spin option, you must deselect the Accela Wash option.

## SORTING WASH LOADS

### Fabric Care Labels

Many articles of clothing include a fabric care label. Using the chart below, adjust the cycle and option selections to care for your clothing according to the manufacturer's recommendations.

<b>Fabric Care Labels</b>			
Machine wash cycle	 Normal	 Permanent press/ wrinkle resistant	 Gentle/ delicate
	 Hand wash	 Do not wash	 Do not wring
Water temperature	 Hot	 Warm	 Cold/cool
Bleach symbols	 Any bleach (when needed)	 Only non-chlorine bleach (when needed)	 Do not bleach

### Grouping Similar Items

For the best washing results, and to reduce the possibility of damage to clothing, care should be taken to sort the clothing into loads that are made up of similar items. Mixing different fabric types and/or soil levels can result in poor wash performance, color transfer or discoloration, fabric damage or linting. Fabrics should be sorted into groups as described below.

#### Colors

Sort articles by color. Wash dark clothes together in a separate load from light colors or whites. Mixing dark clothes with light clothes can result in dye transfer or discoloration of the lighter clothes.

#### Soil Level

Wash heavily soiled clothing together. Washing lightly soiled clothing in the same load with heavily soiled clothing could result in poor wash performance for the lightly soiled clothing.

#### Fabric Type

Delicate articles should not be mixed with heavier or sturdier fabric types. Washing delicates in a load with heavy fabrics can result in damage to the more delicate fabrics. Washing heavier fabrics in a delicate load can result in poor wash performance for the heavier fabrics and possible damage to the delicates.

#### Lint Type

Some fabrics attract and bind lint to them while others give off lint in the laundry process. Avoid mixing these lint collectors and lint producers in the same load. Mixing these fabrics will result in pilling and linting on the lint collectors. (For example, lint collector – knit sweater; lint producer – terrycloth towels.)

### Loading the Washer

- Check all pockets to make sure that they are empty. Items such as clips, matches, pens, coins, and keys can damage both your washer and your clothes.
- Close zippers, hooks, and drawstrings to prevent these items from snagging or tangling on other clothes.
- Pretreat heavily stained areas for best results.
- Combine large and small items in a load. Load large items first.
- Large items should not be more than half of the total wash load.
- The drum should not be tightly packed with items. The door of the washer should close easily.
- To prevent an out-of-balance load, do not wash single items. Add one or two similar items to the load. Large, bulky items, such as a blanket, comforter, or bedspread, should be washed individually.
- Do not wash or spin waterproof items, such as rain coats, sleeping bags, etc.
- When unloading the washer, check under the door seal for small items.

**NOTE:** Make sure that the door seal area is clear when closing the door. Overloading the washer can cause items to get caught between the door and the seal. This can damage both the items and the seal.



Sort Laundry...

- For best performance, load clothes as shown.

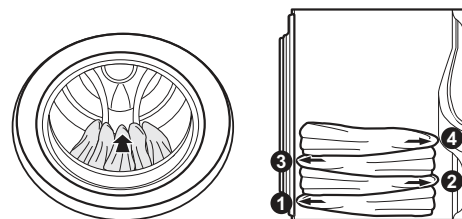

- Load clothes loosely, and do not overfill the drum. Clothes need room to circulate in order to get clean.
- Do not press down on items while stacking them in the drum.



## ABOUT THE DISPENSER DRAWER

The automatic dispenser consists of four compartments which hold:

- Liquid chlorine bleach.
- Liquid fabric softener.
- Liquid or powdered detergent for prewash.
- Liquid or powdered detergent and color-safe bleach for main wash.

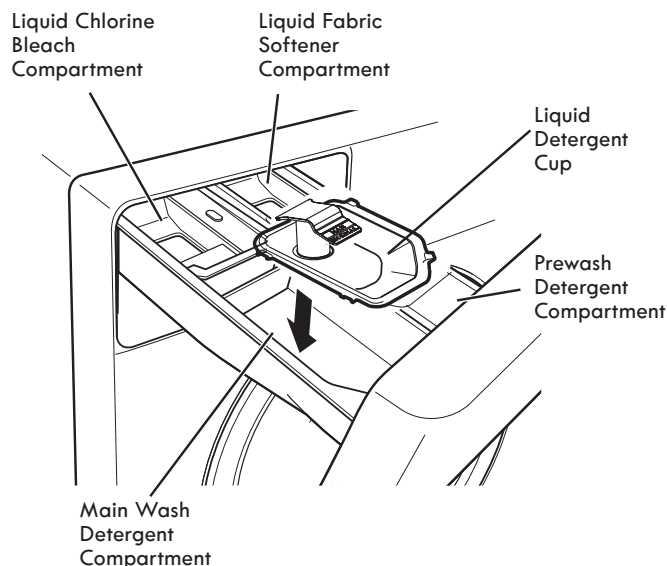

### Pre-Wash Detergent Compartment

Add liquid or powdered detergent to this compartment when using the Pre-Wash option. Always use High-Efficiency (HE) detergent with your washing machine.

The amount of detergent added for the Pre-Wash option should be  $\frac{1}{2}$  the amount recommended for the main wash cycle. For example, if the main wash cycle requires  $\frac{1}{2}$  measure of detergent, add  $\frac{1}{4}$  measure to the Pre-Wash compartment.

**NOTE:** If using liquid detergent for the main wash when using the Pre-Wash option, the liquid detergent cup accessory must be used in the main wash dispenser. This will prevent the main wash liquid detergent from being dispensed immediately.

### Main Wash Detergent Compartment

This compartment holds laundry detergent for the main wash cycle. The detergent is added to the load at the beginning of the cycle. Always use High-Efficiency (HE) detergent with your washing machine. Either powdered or liquid detergent may be used.

**Never** exceed the manufacturer's recommendations when adding detergent. Using too much detergent can result in detergent buildup in clothing and the washer.

**NOTE:** Liquid or powdered color-safe bleach may be added to the main wash compartment with detergent of the same type. **DO NOT** add liquid or powdered color-safe bleach to the bleach dispenser. **DO NOT** mix liquid and powdered cleaning agents within the same compartment.

### Liquid Bleach Compartment

This compartment holds liquid chlorine bleach, which is dispensed automatically at the proper time during the wash cycle.

- Do not add powdered or liquid color-safe bleach to this compartment. The bleach compartment is designed to dispense liquid chlorine bleach only. Powdered or liquid color-safe bleach will not dispense properly.
- Always follow the manufacturer's recommendations when adding bleach. Do not exceed the maximum fill line since this can cause the bleach to be dispensed immediately, causing damage to fabrics. Using too much bleach can damage fabrics.
- Never pour undiluted liquid chlorine bleach directly onto the load or into the drum. Fabric damage can occur.

### Fabric Softener Compartment

This compartment holds liquid fabric softener, which is automatically dispensed during the final rinse cycle.

Never exceed the manufacturer's recommendations when adding softener. Using too much fabric softener can result in buildup in clothing and the washer. Either powdered or liquid fabric softener may be used.

- Always follow the manufacturer's recommendations when adding fabric softener. Do not exceed the maximum fill line. Using too much fabric softener may stain clothes.
- Dilute concentrated fabric softeners with warm water. Do not exceed the maximum fill line.
- Never pour fabric softener directly onto the load or into the drum.

## DETERGENT AND DISPENSER USE

### A Word About Detergents

High-Efficiency (HE) detergents produce fewer suds, dissolve more efficiently to improve washing and rinsing performance, and help to keep the interior of your washer clean. Using detergent that is not HE may cause oversudsing and unsatisfactory performance which could result in error codes, cycle failure, and machine damage.

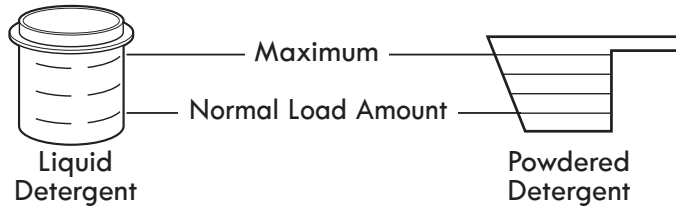

For proper wash performance, always measure the detergent using the measuring device provided by the detergent manufacturer.

The normal amount of HE detergent needed, for average loads, is less than  $\frac{1}{2}$  of the recommended maximum. **Use less detergent** for soft water, light soil or smaller loads. **Never** use more than the maximum amount recommended by the detergent manufacturer.



### Designed to use only High-Efficiency (HE) detergent

**IMPORTANT:** Your washing machine is designed for use with only High-Efficiency (HE) detergents. HE detergents are formulated specifically for front-load washers and contain suds-reducing agents. Always look for the HE symbol when purchasing detergent.

**IMPORTANT:** Not all detergents are the same. Pay careful attention to the amount of detergent used to avoid oversudsing, poor rinsing and detergent buildup in clothing, and residue buildup that can contribute to odors in the machine. **NEVER** use a cup or scoop other than the one supplied by the manufacturer of the detergent you are using. Never use more than the maximum amount of detergent recommended by the manufacturer.

Always measure the detergent amount. While HE detergents are designed for this type of washing machine, be careful when measuring the detergent. For most normal loads, no more than  $\frac{1}{4}$  to  $\frac{1}{2}$  of cap or scoop of HE detergent should be used.

**NOTE:** Extra care must be exercised when using **2X** and **3X** concentrated detergents because even a little bit extra can contribute to the problems mentioned above.

**NOTE:** Detergents designated as HE compatible may not provide optimal results.

### Filling the Dispenser

To add detergent, bleach, and fabric softener to the automatic dispenser:

- 1 Open the dispenser drawer.
- 2 Load the laundry products into the appropriate compartments.
- 3 Close the drawer before starting the cycle.

**NOTE:** It is normal for a small amount of water to remain in the bleach and softener compartments at the end of the cycle.

**IMPORTANT:** Do not place or store laundry products, such as detergent, bleach, or liquid fabric softener, on top of your washer or dryer. Wipe up any spills immediately. These products can damage the finish and controls.

## TIME AND STATUS DISPLAY

The time and status display shows the estimated time remaining, cycle progress, and door lock status.

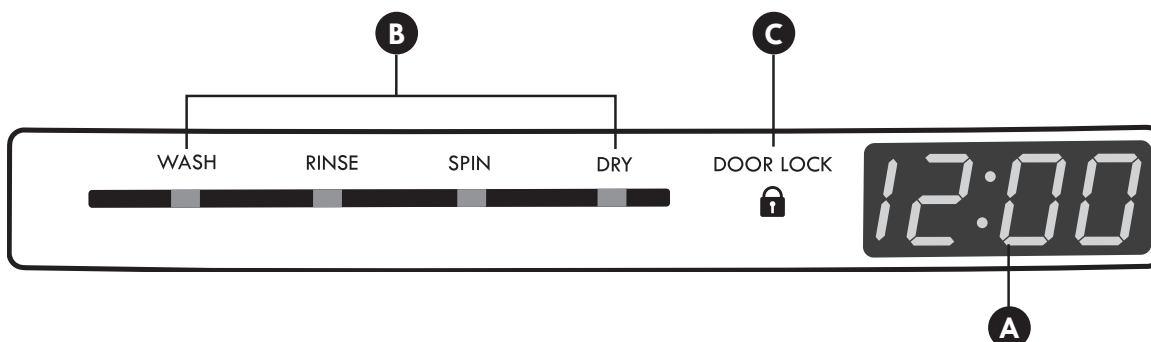

### A ESTIMATED TIME REMAINING

When the START/PAUSE button is pressed, the washer will automatically detect the load size for cycles that use load sensing. The control will then optimize the wash and rinse times, based on the selected cycle, modifiers and options. When the load size has been determined, the display will change from dashes (- - -) to the estimated time for that cycle. For non-load sensing cycles, the estimated time will display when the cycle is selected.

#### NOTE:

- The time shown is only an estimate. For example, the time displayed may pause for a period of time while the machine is heating the water or balancing the load. Under certain conditions, the machine can pause for extended periods of time.
- Estimated time is based on normal operating conditions. Several external factors (load size, room temperature, incoming water temperature, etc.) also affect the length of estimated time vs. actual time.

### B CYCLE STATUS INDICATOR

These status LEDs illuminate to indicate which stage of the cycle is currently running. A blinking light indicates the active stage of the cycle. When that stage is complete, the light will remain steady.

### C DOOR LOCK INDICATOR

Indicates that the door is locked. The washer door will lock while the washer is operating. The door can be unlocked by pressing START/PAUSE to pause the washer.

#### NOTE:

- If the temperature in the washer is too high, the door cannot be unlocked until the washer has cooled.
- If the water level is too high, the door will not unlock. To drain the water, press POWER, then press the SPIN SPEED button without selecting a cycle. Press START/PAUSE and the water will drain and the clothes will spin out. Do not try to force the door open, as this will damage the door.

## CYCLE MODIFIER BUTTONS

Each cycle has default settings that are selected automatically. You may also customize these settings using the cycle modifier buttons. Press the button for the desired modifier until the indicator light for the desired value is lit. The washer automatically adjusts the water level for the type and size of wash load for best results and maximum efficiency. Due to the high-efficiency nature of this product, water levels may be much lower than expected. This is normal operation and cleaning/rinsing performance will not be compromised.

**NOTE:** To protect your garments, not every wash temperature, spin speed, soil level, or option is available with every cycle. A chime will sound and the LED will not light if a selection is not allowed.

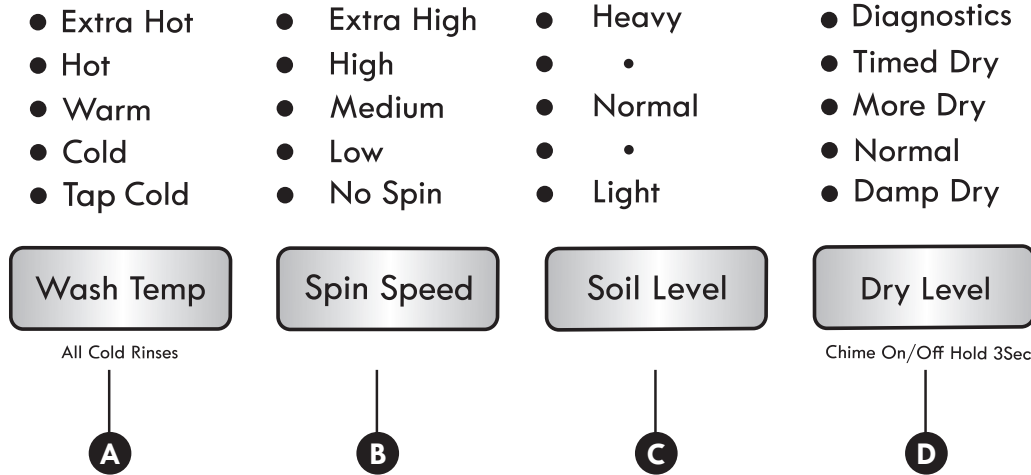

### A WASH TEMP

Wash Temp selects the wash and rinse temperature combination for the selected cycle. Press the Wash Temp button until the indicator light for the desired setting is lit.

- Select the water temperature suitable for the type of load you are washing. Follow the garment fabric care labels for best results.
- Cold rinses use less energy. The actual rinse temperature depends on the temperature of the cold water at the faucet.
- Cold water is used for all rinse cycles.

### B SPIN SPEED

Higher spin speeds extract more water from clothes, reducing drying time and saving energy.

Press the SPIN SPEED button until the desired speed is selected. Some fabrics, such as delicates, require a slower spin speed. To protect your clothing, not all spin speeds are available for all cycles.

#### The Drain & Spin cycle:

1. Press the POWER button to turn ON the washer.
2. Press the SPIN SPEED button to select the desired spin speed. For drain only, select the NO SPIN option.
3. Press the START/PAUSE button. The water will drain and the clothes will tumble before the spin routine begins.

### C SOIL LEVEL

Adjusting the soil level setting will modify the cycle to allow more time for heavily soiled clothes or less time for lightly soiled clothes. Press the SOIL LEVEL button until the desired soil level is selected.

### D DRY LEVEL

Press DRY LEVEL repeatedly to toggle through and select a drying option.

## STEAM CYCLES AND OPTIONS

Your washing machine features several additional cycle options that customize cycles to meet your individual needs.

- 1 Turn ON the washer and turn the cycle selector knob to select the desired cycle.
- 2 Use the cycle modifier buttons to adjust the settings for that cycle.
- 3 Press the cycle option button(s) for the option(s) you would like to add. The button will light when that option is selected. For secondary functions, press and hold the button for three seconds. The LED will blink when the secondary option is selected. Both options cannot be selected together.
- 4 If the selected option is not allowed for the selected cycle, the chime will sound twice to alert you and the LED will not illuminate.
- 5 Press the START/PAUSE button to start the cycle. After a brief delay, the door will lock and the cycle will begin.

**NOTE:** To protect your garments, not every option is available with every cycle.

**NOTE:** If the START/PAUSE button is not pressed within one hour, the control will shut off and the settings will be lost.

### STEAM TREAT



Select the STEAM TREAT button to add steam to the selected cycle for added cleaning power.

Adding steam to cycles helps provide improved cleaning performance. By creating steam, fabrics get the benefit of a deep clean. The steam option is not available on all cycles.

### To add steam to a cycle:

- 1 Turn ON the washer and turn the cycle selector knob to select a cycle that allows the steam option. Refer to the Cycle Guide to see which cycles allow steam.
- 2 Press the STEAM TREAT button. The washer will automatically adjust the cycle settings.
- 3 Set any other desired options.
- 4 Press the START/PAUSE button to start the cycle.

### NOTE:

The door may be very warm during steam cycles. This is normal.

Do not attempt to override the door lock mechanism or reach into the washer during a steam cycle. Steam can cause severe burns.

### IMPORTANT NOTES ABOUT STEAM CYCLES:

- Steam may not be visible during the steam cycles. This is normal.
- Do not use steam with delicate fabrics such as wool, silk, or easily discolored fabrics.

### ACCELA WASH



The Accela Wash option uses a twin water-spray and detergent injection which reduces cycle time while maintaining wash performance when added to a cycle.

### PRE WASH



Select this option to add a 15-minute prewash, rinse and spin cycle to the chosen cycle. This is especially useful for heavily soiled items.

### EXTRA RINSE



This option will add an extra rinse to the selected cycle. Use this option to help ensure the removal of detergent or bleach residue from fabrics.

### DELAY START



Once you have selected the cycle and other settings, press this button to delay the start of the wash cycle. Each press of the button increases the delay time by one hour, for up to 19 hours. Once the desired delay time is set, press the START/PAUSE button to start the delay time.

### STAY FRESH



This feature helps keep wrinkles from setting in clothes and helps keep them fresh if they are not removed from the washer as soon as the cycle is complete. Press the STAY FRESH button to tumble the clothes intermittently and circulate fresh air through the drum for up to nineteen hours. Press the POWER button or the START/PAUSE button to remove clothes at any time.

**STEAM CYCLES AND OPTIONS****ADD GARMENTS**

Use this function to add garments or remove foreign objects like coins or keys after the cycle has started.

- 1** Press ADD GARMENTS. The cycle pauses and the door unlocks.
- 2** Open the door, add garments or remove foreign objects, and close the door.
- 3** Press START/PAUSE to restart the cycle. The cycle continues automatically.

**NOTE:**

- After checking the water level/temperature conditions for safety, the door unlocks once the wash movement has stopped. (Door Lock LED turns off.)
  - This may take several seconds depending on the water level. When a lot of water is in the tub, the door unlocks after water drains to a safe level.
  - If the temperature in the tub is higher than 113°F (45°C), a short warning chime sounds and ADD GARMENTS is NOT allowed for safety.
- ADD GARMENTS is disabled during the CLEAN WASHER cycle for safety.
- To preserve wash performance, wash time may be extended depending on when garments are added to a cycle.

**WARNING:**

- Be careful when opening the door as wet laundry may drip or fall out when the door is opened.
- Do not attempt to force the door to open when locked. Doing so could result in damage to the machine, malfunction, or personal injury.
- Make sure the area around the door seal is clear before closing the door. If laundry gets caught between the door and the seal, it can damage the rubber gasket and may result in leaking.

## SPECIAL FUNCTIONS

### CLEAN WASHER



Detergent residue can build up in the wash drum over time and can lead to a mildewy or musty smell. The CLEAN WASHER cycle is specially designed to remove this buildup using bleach or another cleaner designed specifically for cleaning front load washers. Run the CLEAN WASHER cycle once a month, or more often under heavy use conditions or if odor is present. See complete instructions in the CARE AND CLEANING section.

- 1 Turn ON the washer and press and hold the ACCELA WASH button for three seconds. Selecting any other cycle after CLEAN WASHER has been selected will cause the CLEAN WASHER cycle to be cancelled.
- 2 Fill the bleach dispenser to the MAX line with liquid chlorine bleach. Do not overfill the bleach dispenser. Overfilling will cause the bleach to dispense immediately.  
**NOTE:** For other drum cleaning products, follow the cleaner manufacturer's instructions and recommendations. For powdered cleaning products, add the cleaner to the main wash compartment of the dispenser drawer. Place tablet cleaners directly into the drum.
- 3 Press the START/PAUSE button to start the cycle.
- 4 After the cycle has ended, secure the door slightly ajar with the door magnet. This will promote air circulation and allow the interior of the machine to dry. To use this feature, close the door just until it contacts the door magnet.  
**NOTE:** Do NOT use this cycle with clothes, and do NOT add detergent or fabric softener.

### AUTO SOAK



Use the AUTO SOAK option to presoak garments to help remove difficult spots or stains on fabric. This option provides a 30-minute presoak prior to the start of the selected cycle. At the end of the presoak time, the selected cycle will use the same water.

To use the AUTO SOAK feature, press and hold the STEAM TREAT button for three seconds.

### ENERGY SAVER



This option saves energy by using cooler water while increasing the wash and rinse times to maintain wash performance. This feature is only available with the NORMAL/CASUAL and HEAVY DUTY cycles as listed below.

To use the Energy Saver option, press and hold the PRE WASH button for three seconds.

- NORMAL – Hot becomes Warm
- NORMAL – Warm becomes Cold
- HEAVY DUTY – Hot becomes Warm

### DRUM LIGHT



The drum is equipped with a blue LED light that illuminates when the washer is turned on. This light automatically turns off when the door is closed and the cycle starts.

To turn on the light during a cycle, press and hold the EXTRA RINSE button for three seconds. The drum light will illuminate and then turn off automatically after four minutes.

**NOTE:** Clothes may appear to be yellow in the washer while the drum light is on. This effect is caused by the reflection of the light.

### CONTROL LOCK



Use this option to disable the controls. The washer can only be locked during a cycle. This feature can prevent children from changing cycles or operating the machine. Once set, the controls remain locked and Control Lock must be turned OFF before the controls can be used again. Once the washer has shut off, the power button will allow the machine to be turned ON, but the controls will still be locked. When the controls are locked, "CL" will display alternately with the estimated time remaining. Press and hold the STAY FRESH button for three seconds to activate or deactivate the controls.

### CHIME



Chime On/Off Hold 3Sec

Press and hold DRY LEVEL button for 3 seconds to set the volume of the chime and keypad tones. You can turn the end-of-cycle chime and keypad tones ON or OFF with the CHIME function.

**DRY****Dry Level**

Chime On/Off Hold 3Sec

Drying options are easily selected with the DRY LEVEL button. For the most even drying, make sure all articles in the load are similar in material and thickness. Do not overload the washer

by placing too many articles into the drum. Items must be able to tumble freely.

If you open the door and remove the load before the washer has finished the Dry cycle, remember to press the START/ PAUSE button.

**Press the DRY LEVEL button to select:**

- 1 NORMAL - For general drying
- 2 MORE DRY- For heavier fabrics
- 3 30/60/90/120/150 - For timed drying
- 4 DAMP DRY - For damp drying fabrics

**NOTE:** The capacity of the machine for washing clothes is twice as much as when drying clothes. If the machine is to be used to dry a load, then the wash load must be reduced by half for effective drying performance. If a full load is washed, remove half the clothes prior to starting the dry cycle.

**Drying Guide—Automatic Dry**

Electronic sensors measure the temperature of the exhaust to increase or decrease the drying temperature for faster reaction time and tighter temperature control.

**Recommended DRY settings by fabric type:**

- a) If clothes are to be ironed – DAMP DRY
- b) Cotton/Towels – NORMAL
- c) Diapers – MORE DRY

**NOTE:** On Automatic Dry settings, the estimated drying time may vary from the actual drying time. The type of fabric, size of the load, and the selected dryness level affect drying time.

**Drying Guide—Timed Dry**

- Press the DRY LEVEL button repeatedly to select the drying time in 30 minute increments: 30–60–90–120 minutes.
- Drying times can vary greatly depending on dampness, room temperature, and type of fabric. You may need to add additional time. Your own experience will be your best guide.

**Dry Only Cycle**

1. Press POWER button.  
Do not turn the cycle selector knob.
2. Press DRY button repeatedly to select the desired dry cycle.
3. Press START/PAUSE button.

**NOTE:**

- If you turn the cycle selector knob, you will be unable to select a Dry Only cycle. If this occurs, press POWER button twice to cycle the machine off and back on.
- All Dry Only cycles begin with a brief spin cycle to extract as much moisture as possible from the load before drying.

**Drying Tips****Woolen Articles**

Do not tumble dry woolen articles. Pull them to their original shape and dry them flat.

**Woven and Loopknit Materials**

- Some woven and loopknit materials may shrink when dried.
- Always stretch them out immediately after drying.

**Permanent Press and Synthetics**

- Do not overload the dryer.
- Take out permanent press articles as soon as the dryer stops to reduce wrinkles.

**Fiber or Leather Materials**

Always check the manufacturer's instructions.

**Baby Clothes and Night Gowns**

Always check the manufacturer's instructions.

**Rubber and Plastics**

Do not dry any items made from or containing rubber or plastics, such as:

- a) Aprons, bibs, chair covers
- b) Curtains and table cloths
- c) Bathmats

**Fiberglass**

Do not dry fiberglass articles in your dryer. Glass particles left in the washer could be picked up by your clothes the next time you use the washer and irritate your skin.



**WARNING:** To reduce the risk of fire, electric shock, or injury to persons, read this entire Use & Care Guide, including the Important Safety Instructions, before operating this washer.

- **Unplug the washer before cleaning to avoid the risk of electric shock.** Failure to follow this warning can cause serious injury, fire, electric shock, or death.
- **Never use harsh chemicals, abrasive cleaners, or solvents to clean the washer.** They will damage the finish.

### REGULAR CLEANING

#### Cleaning the Exterior

Proper care of your washer can extend its life. The outside of the machine can be cleaned with warm water and a mild, nonabrasive household detergent. Immediately wipe off any spills with a soft, damp cloth.

**IMPORTANT:** Do not use solvents, cleaning alcohols, or similar products. Never use steel wool or abrasive cleaners because they can damage the surface.

#### Care and Cleaning of the Interior

Use a towel or soft cloth to wipe around the washer door opening, door seal, and door glass. These areas should be kept clean to ensure a watertight seal. Be sure to wipe under the inside rubber seal to remove any moisture or soil. Always remove items from the washer as soon as the cycle is complete. Leaving damp items in the washer can cause wrinkling, color transfer, and odor. Run the CLEAN WASHER cycle once a month, or more often if needed, to remove detergent buildup and other residue.

#### Clean Washer

- 1 Remove any clothing in the drum.
- 2 Open the dispenser drawer.
- 3 Add liquid chlorine bleach or another drum cleaner designed specifically for cleaning front load washers.
  - **If using liquid chlorine bleach**  
Add liquid chlorine bleach to the bleach compartment of the drawer. (NOTE : Do not exceed the maximum fill line and do not pour undiluted liquid bleach directly into the wash drum.)
  - **If using powdered cleaner**  
Remove the liquid detergent cup and add powdered cleaner to the main wash compartment of the dispenser drawer.
  - **If using tablet cleaner**  
Add tablet cleaner directly to the wash drum.

#### NOTE:

- Do not add tablet cleaner to the dispenser drawer.
  - Do not add any laundry detergent or fabric softener to the drawer when using CLEAN WASHER.
- 4 Turn ON the washer and press and hold the ACCELA WASH button for three seconds, and the LED will blink. Selecting any other cycle after CLEAN WASHER has been selected will cause the CLEAN WASHER cycle to be cancelled.
  - 5 After the cycle ends, open the door and allow the drum interior to dry completely.

**NOTE:** Run the CLEAN WASHER cycle once a month. If a mildewy or musty smell is present, run the CLEAN WASHER cycle once a week for three consecutive weeks.

#### Door Seal and Glass Cleaning

Due to the location and nature of the door seal, some detergent and soil residue may build up on the door glass and seal. Periodic cleaning with a bleach solution can help remove buildup and stains, and can help sanitize the seal to prevent odors.

**NOTE:** Wear rubber gloves and eye protection while performing the following procedure:

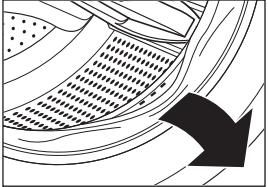
- 1 Dilute  $\frac{3}{4}$  cup (177 ml) liquid chlorine bleach in 1 gallon (3.8 L) of warm/hot water.
- 2 Use this solution to wipe down all surfaces of the gasket and door glass to remove any deposits. Be sure to fold back the lip of the gasket to get under the inner edge where residue can build up.
 
- 3 Dry the gasket and glass with a dry cloth.
- 4 To allow the gasket to dry completely, secure the door slightly ajar with the door magnet. This will promote air circulation and allow the interior of the machine to dry. To use this feature, close the door just until it contacts the door magnet.

#### NOTE:

- Follow the manufacturer's instructions for proper use of bleach.
- To avoid damaging the gasket, NEVER use undiluted bleach to clean the gasket.

#### Removing Mineral Buildup

If you live in an area with hard water, mineral scale can form on internal components of the washer. Use of a water softener is recommended in areas with hard water.

Use a descaler, such as Washer Magic<sup>®</sup>, to remove visible mineral buildup. After descaling, always run the CLEAN WASHER cycle before washing clothing. Do NOT use steel wool or abrasive cleaners.

**REGULAR CLEANING (continued)**

**Storing the Washer**

If the washer will not be used for an extended period of time and is in an area that could be exposed to freezing temperatures, perform the following steps to protect the washer from damage.

- 1 Turn OFF the water supply.
- 2 Disconnect hoses from water supply and drain water from hoses.
- 3 Plug the power cord into a properly grounded electrical outlet.
- 4 Add 1 gallon of nontoxic recreational vehicle (RV) antifreeze to the empty wash drum and close the door.

- 5 Press the POWER button, then press the SPIN SPEED button without selecting a cycle. Press the START/PAUSE button to activate the drain pump. This will expel some of the antifreeze, leaving enough to protect the washer from damage.
- 6 Unplug the power cord, dry the drum interior with a soft cloth, and close the door.
- 7 Refer to the instructions below to clean and dry the dispenser drawer.
- 8 Store the washer in an upright position.
- 9 To remove the antifreeze from the washer after storage, run the EXPRESS WASH cycle. Do not add laundry to this cycle.

**Cleaning the Dispenser**

The dispenser should be cleaned periodically to remove buildup of detergent and other laundry products that can cause the dispenser not to dispense the laundry product properly.

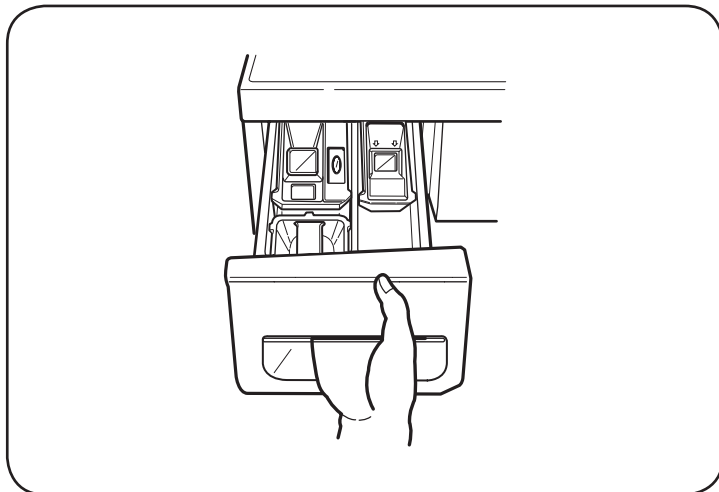

- 1 Pull the dispenser drawer out until it stops.

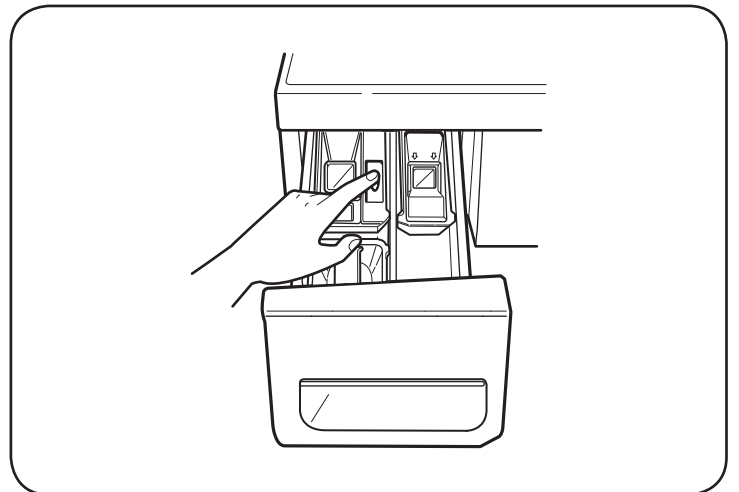

- 2 Press down the lock tab located between the bleach and softener compartments and slide the drawer out.

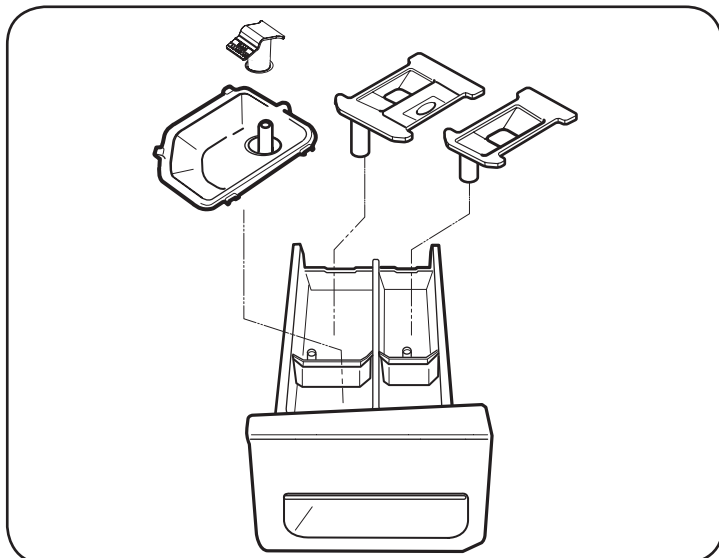

- 3 Remove the liquid detergent box, softener and bleach inserts from their compartments.
- 4 Clean the dispenser compartments and inserts with warm water.

**WARNING:** Certain internal parts are intentionally not grounded and may present a risk of electric shock only during servicing. Service personnel - Do not contact the following parts while the appliance is energized: pump, valve, motor, control board.

## MAINTENANCE

### Cleaning the Water Inlet Filters

If the washer does not fill properly, an error message will show on the display. The inlet valve filter screens could be plugged by hard water scale, sediment in the water supply, or other debris.

**NOTE:** The inlet screens protect the delicate parts of the inlet valve from being damaged by particles that could enter the valves with the water supply. Operating the washer with these filters removed could cause a valve to fail to open, resulting in flooding and/or property damage.

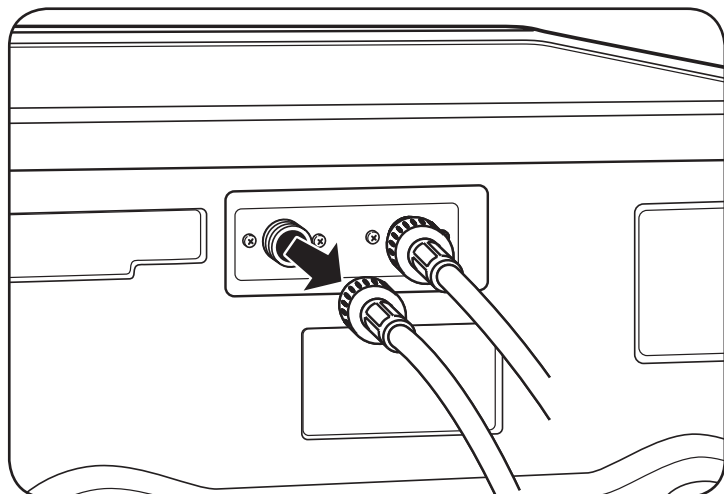

**1** Turn OFF both water faucets completely. Unscrew the hot and cold water lines from the back of the washer.

**IMPORTANT:** ONLY use new, high-quality inlet hoses when installing this laundry product. Aftermarket hoses are not guaranteed to fit or function correctly. Other hoses may not tighten correctly and could cause leaks. Subsequent damage to product or property will not be covered under the terms of the product warranty.

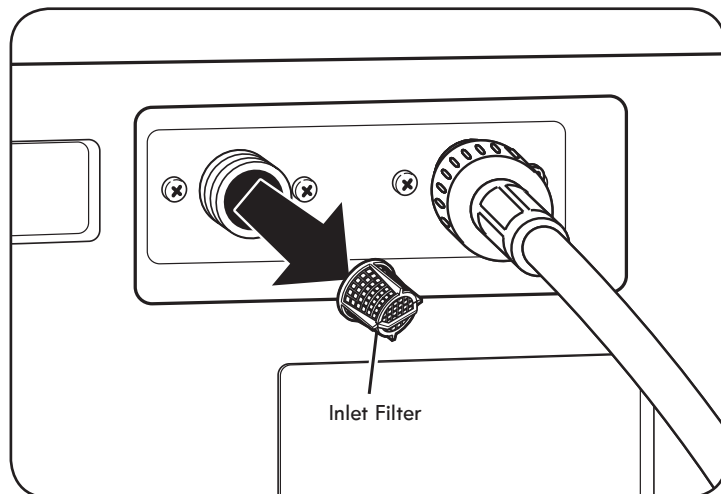

- 2** Carefully remove the filters from the water valves and soak them in white vinegar or a lime scale remover, following the manufacturer's instructions. Be careful not to damage the filters while cleaning.
- 3** Rinse thoroughly before reinstalling. Press the filters back into place.
- 4** Before reattaching the hoses, flush the hoses and water lines by running several gallons of water through the hoses and into a bucket or drain.

## MAINTENANCE (continued)

### Cleaning the Drain Pump Filter

The washer is equipped with a filter that helps prevent excess lint and foreign objects like buttons, keys, and coins from causing damage to the pump. If the washer fails to drain properly, unplug the washer and allow the water to cool, if necessary, before proceeding.

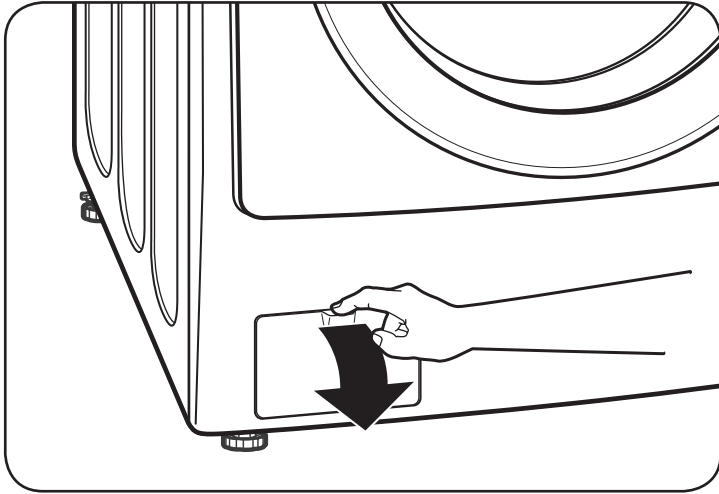

- 1** Open the drain pump filter access panel.

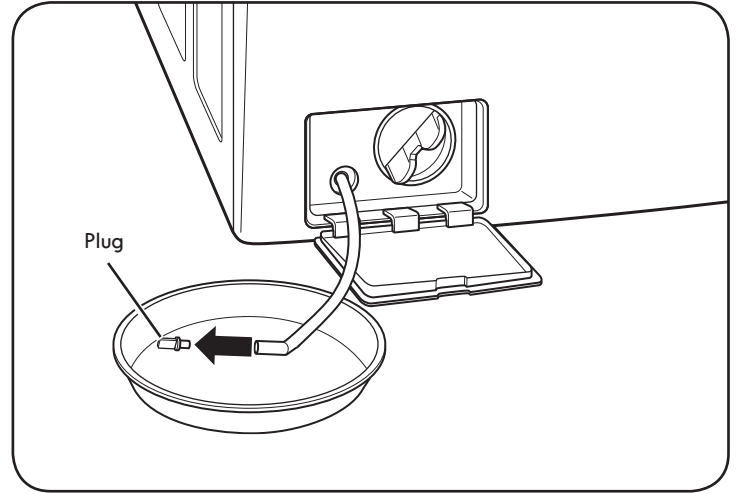

- 3** Remove the plug from the drain hose, and allow the water to drain completely.

**NOTE:** If there is a large amount of water in the drum, you may have to empty your container several times.

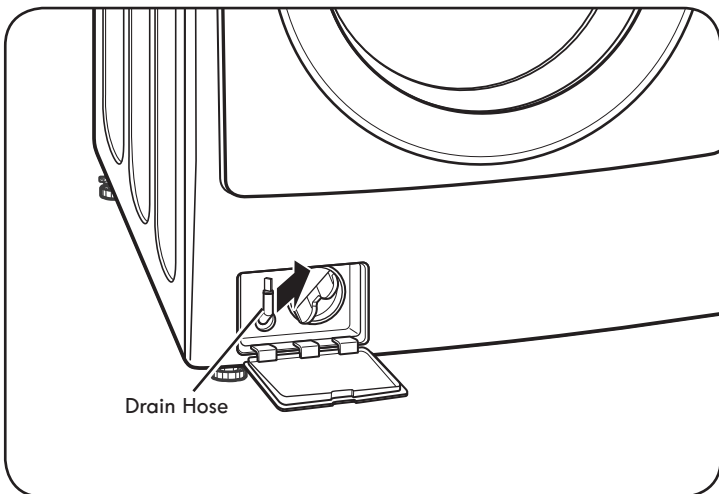

- 2** Unclip the drain hose and pull it out. Place the end of the drain hose into a shallow pan or a floor drain. Make sure not to pull the hose out too far, or it may not drain properly.

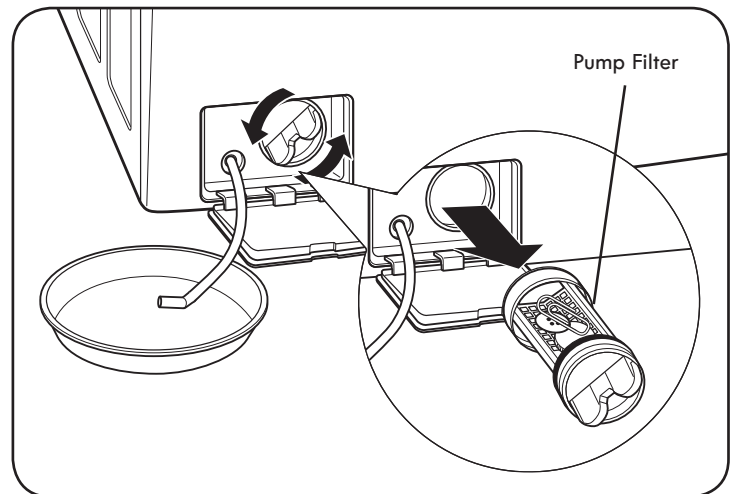

- 4** Twist the pump filter counterclockwise to remove. Remove any lint and foreign objects from the pump filter. Insert pump filter back into opening and twist clockwise to secure. Be sure to close the drain pump filter access panel.

## DIAGNOSTICS

Should you experience any problems with your washing machine, it has the capability of transmitting data via your telephone to the Diagnostics Team. This gives you the capability of speaking directly to our specially trained technicians. The technician records the data transmitted from your machine and uses it to analyze the issue, providing a fast and effective diagnosis.

If you experience problems with your washer, in the U.S.A. call 1-844-553-6667, and in Canada call 1-800-469-4663. Only use the Diagnostics feature when instructed to do so by the Diagnostics Team. The transmission sounds that you will hear are normal and sound similar to a fax machine. Diagnostics cannot be activated unless your washing machine is turned on by pressing the POWER button. If your washing machine is unable to turn on, then troubleshooting must be done without using Diagnostics.

### Using Diagnostics

First, call 1-844-553-6667 (U.S.A.) or 1-800-469-4663 (Canada). If the number of the phone you are using is on file and is associated with your washer, you will be quickly relayed to a Diagnostics team agent. Follow the technician's instructions and perform the following steps only when requested to by the Diagnostics agent.

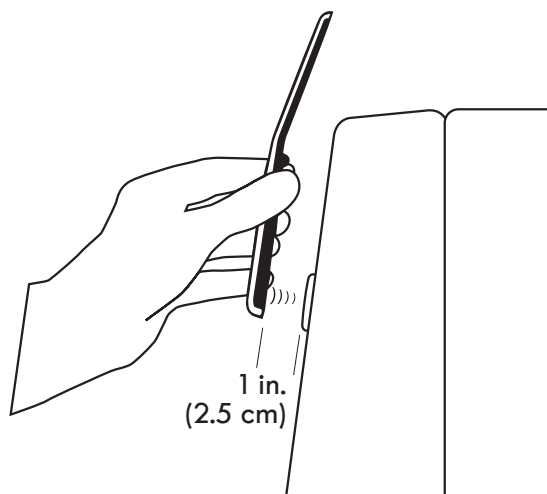
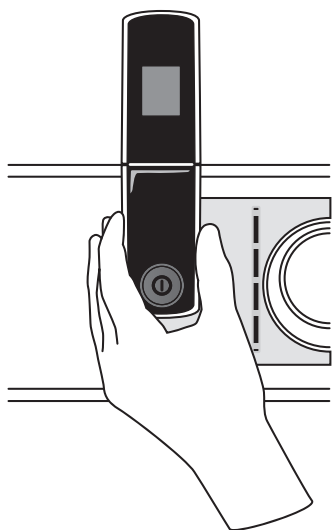

**HOLD** the mouthpiece of your phone over the POWER button, when instructed to do so by the call center, no more than 1 inch (2.5 cm) from (but not touching) the machine.  
**NOTE:** Do not press any other buttons or turn the cycle selector knob.



**PUSH** and hold the WASH TEMP button while continuing to hold your phone to the POWER button.



**LISTEN** for three beeps. After you hear the three beeps, release the WASH TEMP button. Keep the phone in place until the tone transmission has finished. This takes about 6 seconds, and the display will count down the time. Once the countdown is over and the tones have stopped, resume your conversation with the technician, who will then be able to assist you in using the information transmitted for analysis.

#### **NOTE:**

- For best results, do not move the phone while the tones are being transmitted.
- If the call center agent is not able to get an accurate recording of the data, you may be asked to try again.

## NORMAL SOUNDS YOU MAY HEAR

The following sounds may be heard while the washer is operating. They are normal.

**Clicking:**

Door locking mechanism clicks when the door locks and unlocks.

**Spraying or hissing:**

Water spraying or circulating during the cycle.

**Humming or gurgling:**

Drain pump is pumping water from the washer at times during a cycle.

**Splashing:**

Clothes tumbling in the drum during the wash and rinse cycles.

## BEFORE CALLING FOR SERVICE

If your washer does not function properly or does not function at all, check the following before you call for service.



Problem	Possible Cause	Solutions
<b>Rattling and clanking noise</b>	Foreign objects, such as keys, coins, or safety pins, may be in drum or pump.	Stop washer, check drum and drain filter for foreign objects. If noise continues after washer is restarted, call for service.
<b>Thumping sound</b>	Heavy wash loads may produce a thumping sound.  Washer load may be out of balance. Washing shoes or tightly tangled clothes.	This is normal. If sound continues, washer is probably out of balance. Stop and redistribute wash load.  Pause the cycle and redistribute the load after the door unlocks.
<b>Vibrating noise</b>	Shipping bolts and/or packaging materials were not removed.  Wash load may be unevenly distributed in the drum.  Not all leveling feet are resting firmly and evenly on the floor.  Floor not rigid enough.	See the UNPACKING AND REMOVING SHIPPING BOLTS section in the installation requirements.  Pause the cycle and redistribute the load after the door unlocks.  See Leveling the Washer in the Installation Instructions.  Make sure that the floor is solid and does not flex. See Flooring in the Installation Requirements.
<b>Water leaking around washer</b>	Inlet hose connection is loose at tap or washer.  House drain pipes are clogged.  Drain hose has come out of drain. Drain hose is not inserted far enough.  Door glass is dirty.	Check hoses. Check and tighten hose connections.  Unclog drain pipe. Contact a plumber if necessary.  Tie drain hose to inlet hose or standpipe to prevent it from coming out during drain. It should be inserted about 8-12 inches (20.3-30.5 cm) into the standpipe.  Inspect door glass periodically to make sure there is no buildup of residue or other foreign matter. Follow cleaning instructions.
<b>Excessive sudsing</b>	Too much detergent or incorrect detergent.	 Only use detergent with the High-Efficiency (HE) logo. See Detergent Use in the How to Use section.
<b>Staining</b>	Bleach or softener dispensed too soon.  Bleach or softener was added directly to the wash load in the drum.  Washer was not unloaded promptly.  Clothes were not properly sorted.	Dispenser compartment is overfilled causing bleach or softener to dispense immediately.  Dispenser drawer closed too quickly causing bleach or softener to dispense immediately.  Laundry chemicals must be loaded into the dispenser.  Always remove items from the washer as soon as possible after the cycle is complete.  Always wash dark colors separately from light colors and whites to prevent discoloration.  Never wash heavily soiled items with lightly soiled items.

## BEFORE CALLING FOR SERVICE (continued)

Problem	Possible Cause	Solutions
<b>Washer will not turn ON</b>	Power cord is not properly plugged in.  House fuse is blown, circuit breaker has tripped, or power outage has occurred.  House fuse is blown, circuit breaker has tripped, due to multiple appliances on one outlet.	Make sure that the plug is plugged securely into a grounded, 3-prong, 120-VAC, 60-Hz outlet.  Reset circuit breaker or replace fuse. Do not increase fuse capacity. If the problem is a circuit overload, have it corrected by a qualified electrician.  Reset circuit breaker or replace fuse. If more than one appliance is connected to the outlet, call an electrician to have an additional circuit installed.
<b>Door will not unlock when cycle is stopped or paused</b>	Interior temperature of washer is too high.  Water level in washer is too high.	The washer door has a safety feature to prevent personal injury. For example, if the washer is paused during the hot wash stage of a sanitize cycle, the interior temperature of the drum will be very hot, so the door will not unlock. This is normal. Allow the washer to cool until the DOOR LOCK indicator turns OFF on the display.  To drain the water, press POWER, then press the SPIN SPEED button without selecting a cycle.
<b>Wash cycle time is longer than usual</b>	The washer automatically adjusts the wash time for the amount of laundry, water pressure, water heating time and other operating conditions.	This is normal. The washer adjusts cycle time automatically to provide optimal results for the selected cycle. The time remaining shown in the display is only an estimate. Actual time may vary.
<b>Musty or mildewy odor in washer</b>	Incorrect or too much detergent has been used.  Inside of drum was not cleaned properly.	Use only High-Efficiency (HE) detergent in accordance with the manufacturer's instructions.  Run the CLEAN WASHER cycle regularly. Be sure to wipe around and under the door seal frequently. See Care and Cleaning of the Interior.  Clean around door seal/glass to prevent odor.
<b>Wrinkling</b>	Washer not unloaded promptly.  Washer overloaded.  Hot and cold water inlet hoses are reversed.	Always remove items from the washer as soon as the cycle is complete.  When washing large loads, do not overstuff the drum. The washer can be fully loaded, but the drum should not be tightly packed and the door should close easily.  Hot water rinse can set wrinkles in garments. Check the inlet hose connections.
<b>Strange odors coming from washer</b>	Dryer heating.  Newly installed washer.  Build-up of residue on washer, foreign object in door gasket, clogged drain pump filter, clogged or kinked drain hose.	As the dryer heats, it may initially cause a slight odor. This is normal and does not affect performance.  Smell comes from the rubber attached to the washer door. It will eventually dissipate after first couple of wash cycles.  Periodically clean the gasket. Mold and foreign substances inside the gasket may produce mildew or musty smells.  Clean the drain pump filter regularly. Foreign substances on the drain pump filter may produce mildew or musty smells.  If the drain hose is not installed properly, the odor may be emitted because of a backflow of drainage into the tub. Make sure that the drain hose is not kinked or clogged.

**BEFORE CALLING FOR SERVICE (continued)**

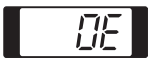
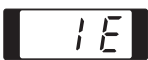
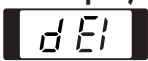
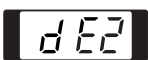
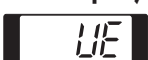
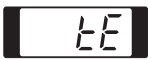
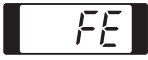
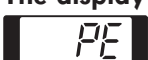
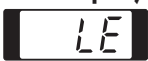
Your washing machine is equipped with an automatic error-monitoring system to detect and diagnose problems at an early stage.

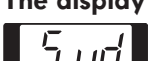
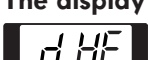
Problem	Possible Cause	Solutions
<b>Water in the washer drains slowly or not at all, or the display shows:</b> 	Drain hose is kinked, pinched, or clogged.  The drain pump filter is clogged.  Drain discharge is more than 96 inches (244 cm) above bottom of washer.	Make sure the drain hose is free of clogs, kinks, etc., and is not pinched behind or under the washer.  Clean the drain pump filter. See Maintenance in the Care and Cleaning section.  Adjust or repair drain. Maximum drain height is 96 inches (244 cm).
<b>Washer fills with water slowly or not at all, or the display shows:</b> 	Water supply faucets are not open fully. Water line hoses are kinked, pinched, or crushed. Water inlet filters are clogged.  Water supply pressure to faucet or house is too low. Water supply connected with leak-limiting hoses.	Make sure that the water faucets are fully open.  Make sure the hoses are not kinked or pinched. Be careful when moving the washer during cleaning and maintenance.  Clean the inlet filters. See Maintenance in the Care and Cleaning section.  Check another faucet in the house to make sure that household water pressure is adequate and flow is not restricted.  Hoses designed to limit leaks can trip falsely and prevent the washer from filling. The use of leak limiting hoses is not recommended.
<b>Cycle won't start, or the display shows:</b>  or 	The door is not closed properly.	Make sure that the door is closed properly and press the START/PAUSE button. After starting a cycle, it may take a few moments before the drum begins to turn or spin. The washer will not operate unless the door is locked.  If the door is closed and locked and the open door error message is displayed, call for service.
<b>The display shows:</b> 	Load is too small. Load is out of balance.	Add 1 or 2 similar items to help balance the load.  The washer has an imbalance detection and correction system. If individual heavy articles are loaded (bath mat, bath robe, etc.) and the imbalance is too great, the washer will make several attempts to restart the spin cycle. If an imbalance is still detected, the washer will stop and the error code will display.
<b>The display shows:</b> 	Control error.	Unplug the washer and wait 60 seconds. Reconnect power and try again. If the error reappears, call for service.
<b>The display shows:</b> 	Water level is too high due to a faulty water valve.	Close the water faucets, unplug the washer, and call for service.
<b>The display shows:</b> 	The water level sensor is not working correctly.	Close the water faucets, unplug the washer, and call for service.
<b>The display shows:</b> 	A motor error has occurred.	Allow the washer to stand for 30 minutes and then restart the cycle. If the LE error code persists, call for service.
<b>The display shows:</b> 	A power failure has occurred.	If the power to the washer has been interrupted during a cycle, the PF error code will display the next time the washer is turned ON. This will alert you to the fact that the previous cycle may not have been completed. Select any cycle to clear the error code and use the washer.
<b>The display shows:</b> 	If the washing machine detects too many suds, it displays this error code and adds a Suds Reducing cycle. This adds about two hours to the cycle time. If too many suds are detected during spinning, the washing machine stops to help prevent leaking.	Do not add more than the manufacturer's recommended amount of detergent.  To remove suds, turn the washer off and on, then run the Rinse & Spin cycle.
<b>The display shows:</b> 	Dry heating error	Unplug the washer and wait 60 seconds. Reconnect power and try again. If the error reappears, call for service.



**KENMORE ELITE LIMITED WARRANTY**

WITH PROOF OF SALE the following warranty coverage applies when this appliance is correctly installed, operated and maintained according to all supplied instructions.

**One Year on Appliance**

FOR ONE YEAR from the date of sale this appliance is warranted against defects in material or workmanship. A defective appliance will receive free repair. If the appliance cannot be repaired it will be replaced free of charge.

**Lifetime on Washer Drive Motor**

FOR AS LONG AS IT IS USED from the date of sale, a free replacement will be supplied for a defective washer drive motor.\* If the defect appears within the first year, a new motor will be installed at no charge.

If the defect appears after the first year, a new motor will be supplied but not installed at no charge. This Lifetime warranty covers only the washer drive motor, and does not apply to any other related component or mechanism. You are responsible for the labor cost of motor installation after the first year from the date of sale.

\*Defects must be verified by a Sears authorized service technician.

For warranty coverage details to obtain free repair, visit the web page:

[www.kenmore.com/warranty](http://www.kenmore.com/warranty)

All warranty coverage applies for only 90 DAYS from the sale date if this appliance is ever used for other than private household purposes.

**This warranty covers ONLY defects in material and workmanship, and will NOT pay for:**

1. Expendable items that can wear out from normal use, including but not limited to filters, belts, bags or screw-in base light bulbs.
2. A service technician to clean or maintain this appliance, or to instruct the user in correct appliance installation, operation and maintenance.
3. Service calls to correct appliance installation not performed by Sears authorized service agents, or to repair problems with house fuses, circuit breakers, house wiring, and plumbing or gas supply systems resulting from such installation.
4. Damage to or failure of this appliance resulting from installation not performed by Sears authorized service agents, including installation that was not in accord with electrical, gas or plumbing codes.
5. Damage to or failure of this appliance, including discoloration or surface rust, if it is not correctly operated and maintained according to all supplied instructions.
6. Damage to or failure of this appliance, including discoloration or surface rust, resulting from accident, alteration, abuse, misuse or use for other than its intended purpose.
7. Damage to or failure of this appliance, including discoloration or surface rust, caused by the use of detergents, cleaners, chemicals or utensils other than those recommended in all instructions supplied with the product.
8. Damage to or failure of parts or systems resulting from unauthorized modifications made to this appliance.
9. Service to an appliance if the model and serial plate is missing, altered, or cannot easily be determined to have the appropriate certification logo.

**Disclaimer of implied warranties; limitation of remedies**

Customer's sole and exclusive remedy under this limited warranty shall be product repair or replacement as provided herein. Implied warranties, including warranties of merchantability or fitness for a particular purpose, are limited to one year on the appliance and for as long as used on the washer drive motor, or the shortest period allowed by law. Seller shall not be liable for incidental or consequential damages. Some states and provinces do not allow the exclusion or limitation of incidental or consequential damages, or limitation on the duration of implied warranties of merchantability or fitness, so these exclusions or limitations may not apply to you.

This warranty applies only while this appliance is used in the United States.

This warranty gives you specific legal rights, and you may also have other rights which vary from state to state.

**Sears Brands Management Corporation, Hoffman Estates, IL 60179**

# Kenmore®

## Customer Care Hotline

To schedule in-home repair service  
or order replacement parts

Para pedir servicio de reparación  
a domicilio, y ordenar piezas

# 1-844-553-6667

[www.kenmore.com](http://www.kenmore.com)

