



Devonshire®
Toilet Tissue Holder
K-10554

Features

- Premium metal construction for durability.
- KOHLER finishes resist corrosion and tarnish.
- Coordinates with other products in the Devonshire collection.
- Tools and installation template included.



Codes/Standards







None Applicable

**KOHLER® Faucet Lifetime Limited
Warranty**

See website for detailed warranty information.

Available Color/Finishes

Color tiles intended for reference only.

Color	Code	Description
	CP	Polished Chrome
	SN	Vibrant® Polished Nickel
	PB	Vibrant® Polished Brass
	BN	Vibrant® Brushed Nickel
	BV	Vibrant® Brushed Bronze
	2BZ	Oil-Rubbed Bronze

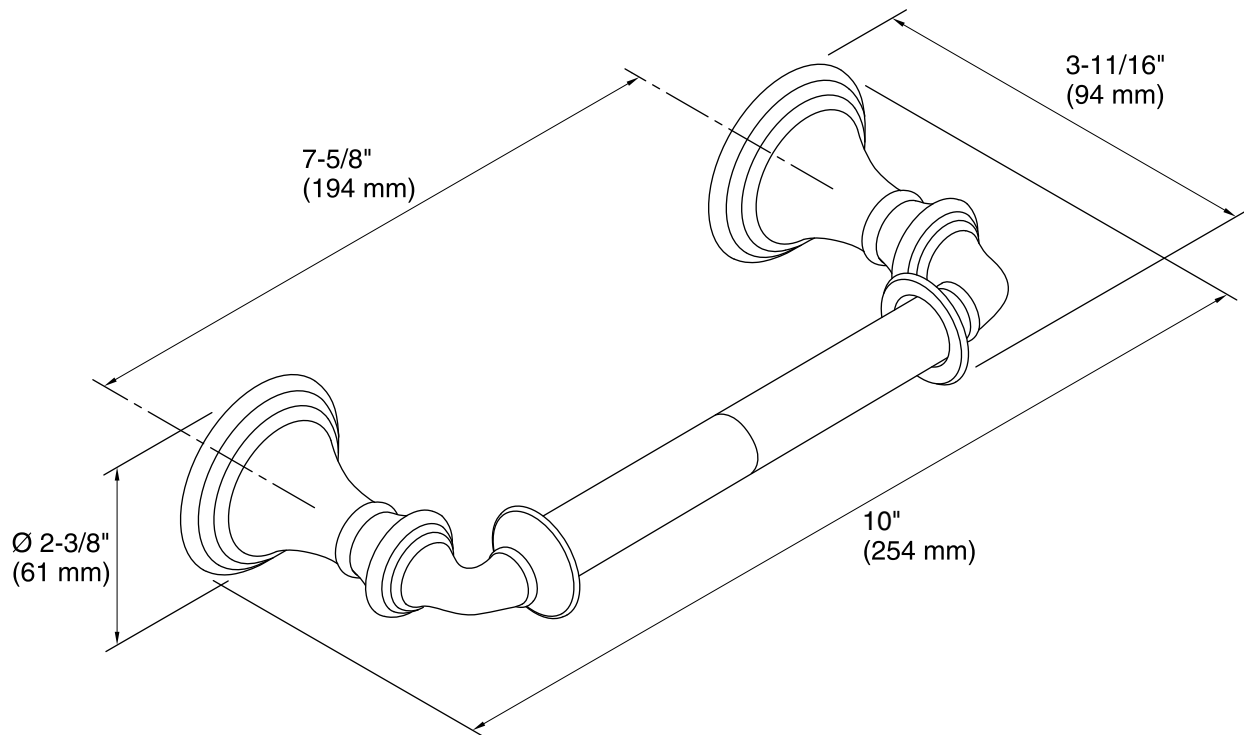

Technical Information

All product dimensions are nominal.

Notes

Install this product according to the installation guide.