

Portable Air Conditioner

Owner's Manual

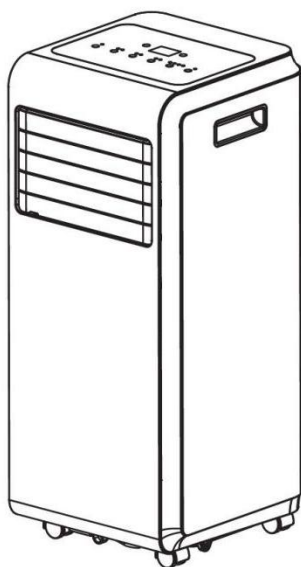

Item No.:A4217-10K-WAL-KI
Model No.:OL-BA010F-06CD/F

(With R32 refrigerant)

READ AND SAVE THESE INSTRUCTIONS

CONTENTS

1. BEFORE YOU BEGIN
2. FOR YOUR SAFETY
3. PRODUCT OVERVIEW
4. INSTALLATION
5. OPERATION
6. CLEANING AND CARE
7. TROUBLESHOOTING
8. DECOMMISSIONING

1. BEFORE YOU BEGIN

1.1 PRODUCT DESCRIPTION

Our powerful portable air conditioners are great cooling solutions for single rooms, creating a comfortable atmosphere in your space. It also has ventilation and dehumidifying function for circulating air and removal of moisture. They're self-contained systems that do not require any permanent installation allowing you to move to the space in which it is most needed. They're commonly used in kitchens, temporary-resided, computer rooms, garages, and many other places where installation of Air-conditioner Outdoor Unit is limited.

The environmentally friendly R32 is used as the refrigerant. R32 has no damaging influence on the ozone layer (ODP), a negligible greenhouse effect (GWP) and is available worldwide. Because of its efficient energy properties, R32 is highly suitable as a coolant for this application. Special precautions must be taken into consideration due to the coolant's high flammability.

1.2 SYMBOLS FROM THE UNIT AND USER MANUAL



This unit uses a flammable refrigerant.

If refrigerant leaks and comes in contact with a fire or heating part, it will create harmful gas and there is a risk of fire.



Read the USER MANUAL carefully before operation.



Further information is available in the USER MANUAL, SERVICE MANUAL, and the like.



Service personnel are required to carefully read the USER MANUAL and SERVICE MANUAL before operation.

THE FOLLOWING SHOULD ALWAYS BE OBSERVED FOR SAFETY

- This appliance is intended to be used by an expert or trained users in shops, in light industry and on farms, or for commercial use by lay persons.
- This appliance can be used by children over the age of 8 and persons with reduced physical, sensory or mental capabilities or lack of experience and knowledge if they have been given supervision or instruction concerning use of the appliance in a safe way and understand the hazards involved. Children shall not play with the appliance. Cleaning and user maintenance shall not be done by children without supervision.
- The unit is designed only for use with R32 gas as the designated refrigerant.
- **The refrigerant loop is sealed. Only a qualified technician should attempt to service!**
- Do not discharge the refrigerant into the atmosphere.
- R32 is flammable and heavier than air.
- It collects first in low areas but can be circulated by the fans.
- If R32 gas is present or even suspected, do not allow untrained personnel to attempt to find the cause.
- The R32 gas used in the unit has no odor.
- The lack of smell does not indicate a lack of escaped gas.
- If a leak is detected, immediately evacuate all persons from the store, ventilate the room and contact the local fire department to advise them that an R32 gas leak has occurred.
- Do not let any persons back into the room until the qualified service technician has arrived and that technician advises that it is safe to return to the room.
- No open flames, cigarettes or other possible sources of ignition should be used inside or in the vicinity of the units.
- Component parts are designed for R32 gas and non-incentive and

non-sparking. Component parts shall only be replaced with identical repair parts.

FAILURE TO ABIDE BY THIS WARNING COULD RESULT IN AN EXPLOSION, DEATH, INJURY AND PROPERTY DAMAGE.

2. FOR YOUR SAFETY

Your safety is the most important thing we we are concerned about !



WARNING

Please read this manual carefully and fully understand it before operating your appliance.



2.1 OPERATIONAL PRECAUTIONS

WARNING- to reduce the risk of fire, electric shock or injury to persons or property:

- If the supply cord is damaged, it must be replaced by the manufacturer, its service agent or similarly qualified persons in order to avoid a hazard.
- The appliance shall be disconnected from its power source during service.
- Always operate the unit from a power source of equal voltage, frequency and rating as indicated on the product identification plate.
- Always use a power outlet that is grounded.
- Unplug the power cord when cleaning or when not in use.
- Do not operate with wet hands. Prevent water from spilling onto the unit.
- Do not immerse or expose the unit to rain, moisture or any other liquid.
- Do not leave the unit running unattended. Do not tilt or turn over the unit.

- Do not unplug while the unit is operating.
- Do not unplug by pulling on the power cord.
- Do not use an extension cord or an adapter plug.
- Do not put objects on the unit.
- Do not climb or sit on the unit.
- Do not insert fingers or other objects into the air outlet.
- Do not touch the air inlet or the aluminum fins of the unit.
- Do not operate the unit if it is dropped, damaged or showing signs of product malfunction.
- Do not clean the appliance with any chemicals.
- Ensure the unit is far away from fire, inflammable, or explosive objects.
- The unit shall be installed in accordance with national wiring regulations.
- Do not use means to accelerate the defrosting process or to clean, other than those recommended by the manufacturer.
- The appliance shall be stored in a room without continuous operation sources (for example: open flames, an operating gas appliance or an operating electric heater).
- The appliance shall be stored so as to prevent mechanical damage from occurring.
- Do not piece or burn, even after use.
- Be aware that refrigerants may not contain an odour.
- Pipe-work shall be protected from physical damage and shall not be installed in an unventilated space, if that space is smaller than 4 m² .

- Compliance with national gas regulations shall be observed.
- Keep any required ventilation openings clear of obstruction.
- The appliance shall be stored in a well-ventilated area where the room size corresponds to the room area as specified for operation.

| | |
|--|--|
|  <p>WARNING</p> | <p>Any person who is involved with working on or breaking into a refrigerant circuit should hold a currently valid certificate from an industry-accredited assessment authority, which authorizes their competence to handle refrigerants safely in accordance with an industry-recognized assessment specification.</p> |
|  <p>WARNING</p> | <p>Servicing shall only be performed as recommended by the equipment manufacturer. Maintenance and repair requiring the assistance of other skilled personnel shall be carried out under the supervision of the person competent in the use of flammable refrigerants.</p> |

If you don't understand something or need help, please contact the dealer services.

2.2 SAFETY PRECAUTIONS ON SERVICING

Please follow these warnings when to undertake the following when servicing an appliance with R32.

2.2.1 Checks to the area

Prior to beginning work on systems containing flammable refrigerants, safety checks are necessary to ensure that the risk of ignition is minimized. For repair to the refrigerating system, the following precautions shall be complied with prior to conducting work on the system.

2.2.2 Work procedure

Work shall be undertaken under a controlled procedure so as to minimize the risk of flammable gas or vapor being present while the work is being performed.

2.2.3 General work area

All maintenance staff and others working in the local area shall be instructed on the nature of work being carried out. Work in confined spaces shall be avoided. The area around the work space shall be sectioned off. Ensure that the conditions within the area have been made safe by control of flammable material.

2.2.4 Checking for presence of refrigerant

The area shall be checked with an appropriate refrigerant detector prior to and during work, to ensure the technician is aware of potentially flammable atmospheres. Ensure that the leak detection equipment being used is suitable for use with flammable refrigerants, i.e. no sparking, adequately sealed or intrinsically safe.

2.2.5 Presence of fire extinguisher

If any hot work is to be conducted on the refrigeration equipment or any associated parts, appropriate fire extinguishing equipment shall be available to hand. Have a dry powder or CO₂ fire extinguisher adjacent to the charging area.

2.2.6 No ignition sources

No person carrying out work in relation to a refrigeration system that involves exposing any pipe work that contains or has contained flammable refrigerant shall use any sources of ignition in such a manner that it may lead to the risk of fire or explosion. All possible ignition sources, including cigarette smoking, should be kept sufficiently far away from the site of installation, repairing, removal and disposal, during which flammable refrigerant can possibly be released into the surrounding space. Prior to work takes place, the area around the equipment is to be surveyed to make sure that there are no flammable hazards or ignition risks. "No Smoking" signs shall be displayed.

2.2.7 Ventilated area

Ensure that the area is in the open or that it is adequately ventilated before breaking into the system or conducting any hot work. A degree of ventilation shall continue during the period that the work is carried out. The ventilation should safely disperse any released refrigerant and preferably expel it externally into the atmosphere.

2.2.8 Checks to the refrigeration equipment

Where electrical components are being changed, they shall be fit for the purpose and to the correct specification. At all times the manufacturer's maintenance and service guidelines shall be followed. If in doubt consult the manufacturer's technical department for assistance.

The following checks shall be applied to installations using flammable refrigerants:

- The charge size is in accordance with the room size within which the refrigerant containing parts are installed;
- The ventilation machinery and outlets are operating adequately and are not obstructed;
- If an indirect refrigerating circuit is being used, the secondary circuit shall be checked for the presence of refrigerant;
- Marking the equipment continues to be visible and legible. Markings and signs that are illegible shall be corrected;

– refrigeration pipe or components are installed in a position where they are unlikely to be exposed to any substance which may corrode refrigerant-containing components, unless the components are constructed of materials which are inherently resistant to being corroded or are suitably protected against being so corroded.

2.2.9 Checks to electrical devices

Repair and maintenance of electrical components shall include initial safety checks and component inspection procedures. If a fault exists that could compromise safety, then no electrical supply shall be connected to the circuit until it is satisfactorily dealt with. If the fault cannot be corrected immediately but it is necessary to continue operation, an adequate temporary solution shall be used. This shall be reported to the owner of the equipment so all parties are advised.

Initial safety checks shall include:

- those capacitors are discharged: this shall be done in a safe manner to avoid possibility of sparking;
- that there is no live electrical components and wiring are exposed while charging, recovering or purging the system;
- that there is continuity of earth bonding.



WARNING!

Install the unit in rooms which that exceed 4 m².

Do not install the unit in a place where inflammable gas may leak.



NOTE!

The manufacturer may provide other suitable examples or may provide additional information about the refrigerant odour.

3. PRODUCT OVERVIEW

3.1 PRODUCT DIAGRAM

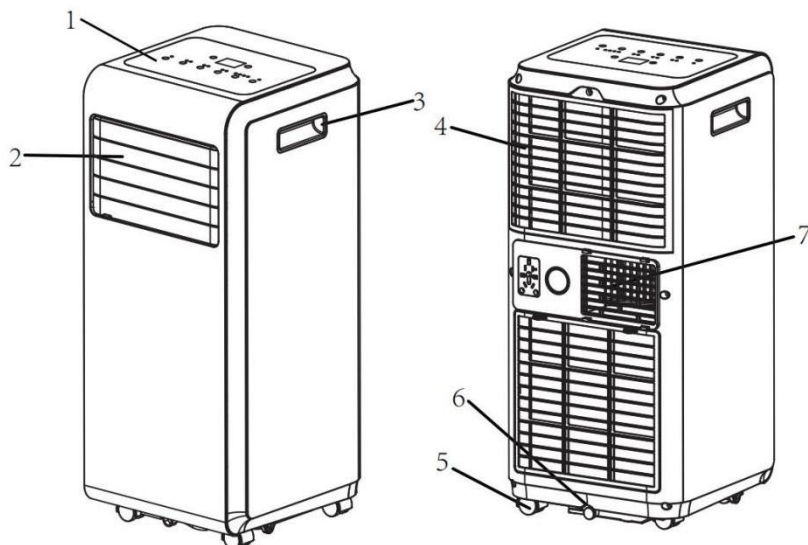

| | | | | | |
|---|-----------------------------------|---|---------------------------|---|---------------|
| 1 | Control panel | 4 | Air inlet with air filter | 6 | Drainage Hole |
| 2 | Air outlet with adjustable louver | 5 | Caster | 7 | Air Exhaust |
| 3 | Handle | | | | |

Note: The appearance is only for reference. Please check the real product for detailed information.

3.2 FEATURES

- ✓ High Capacity in a compact size with cooling, dehumidifying and fan functions.
- ✓ Temperature setting and display
- ✓ LED Digital display
- ✓ Electronic control with a built-in timer, sleep mode
- ✓ Self-evaporating system for better efficient
- ✓ Auto shut off when tank full
- ✓ Automatic restart in the event of power outage
- ✓ Auto defrosting function at low ambient temperatures
- ✓ Remote control
- ✓ 2- speed fan
- ✓ Casters for easy mobility

4. INSTALLATION

4.1 UNPACKING

- Unpack the carton and take the appliance and accessories out.
- Check the device after unpacking for any damage or scratches on it.
- Accessories:
 - 1. Exhaust hose
 - 2. Hose connector
 - 3. Window kit adapter
 - 4. Remote control
 - 5. Window kit
 - 6. Water pipe
 - 7. User manual

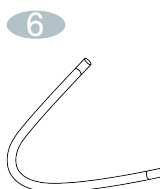
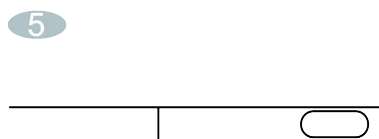
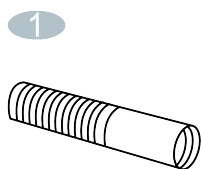

4.2 Choose your location

- If tipped more than 45°, allow the unit to set upright for at least 24 hours before starting up.
- Place the unit on a firm, level surface in an area with at least 50cm of free space around it to allow for proper air circulation.
- Do not operate in close proximity to walls, curtains, or other objects that may block the air inlet and outlet. Keep the air inlet and outlet free of obstacles.
- **Never** install the unit where it could be subject to:
 - Heat sources such as radiators, heat registers, stoves or other products that produce heat.
 - Direct sunlight
 - Mechanical vibration or shock
 - Excessive dust
 - Lack of ventilation, such as cabinet or bookcase
 - Uneven surface

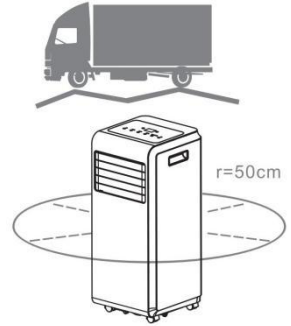

WARNING!

Install the unit in rooms that exceed 4 m².

Do not install the unit in a place where inflammable gas may leak.



NOTE!

The manufacturer may provide other suitable examples or may provide additional information about the refrigerant odour.

4.3 ATTACH THE EXHAUST HOSE

The air conditioner requires being vented outside so that the exhaust air can escape the room which comes from the appliance contains waste heat and moisture.

Do not replace or extend the exhaust hose which will result in decreased efficiency, even worse shut down the unit due to low back pressure.

Step 1: Connect the hose connector to one end of the exhaust hose.

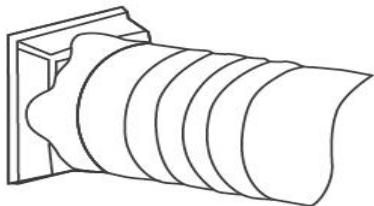

Step 2: Connect the windows kit adapter to the other end of the exhaust hose.

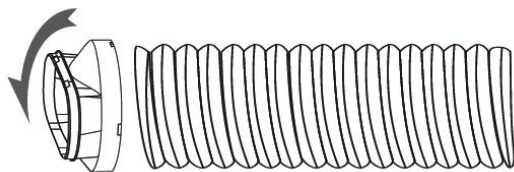

Step 3: Extend the adjustable window kit to the length of your window. Connect the exhaust hose to the window kit.



Step 4: Close your window to secure the kit in place. It needs to hold

the windows kit firmly in place, and secure the window kit with duct tape if required. It is recommended that the gap between the adapter and the sides of the window should be sealed off for maximum efficiency.

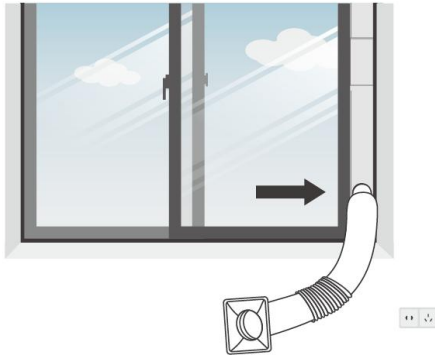

Step 5: Attach the hose connector to the exhaust air outlet of unit.

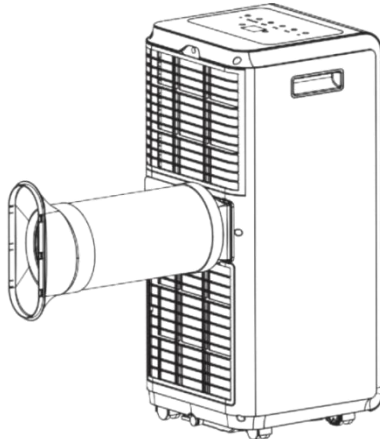

Step 6: Adjusting the length of the flexible exhaust hose, to make sure the distance between the unit and the window will be more than 70cm, the height from exhaust hose to the floor will be more than 90cm. And avoid bends in the hose. Then place AC near an electrical outlet.

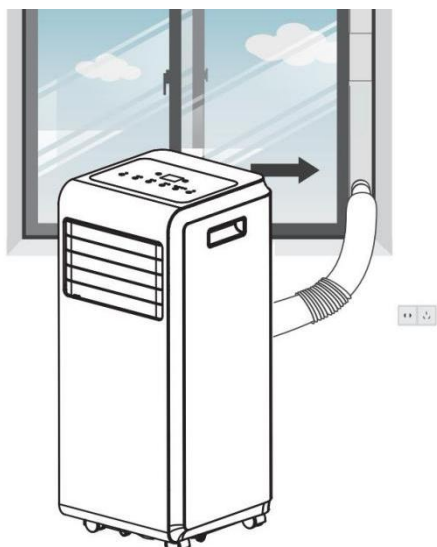

Step 7: Adjust the louver at the air outlet, and then switch on the unit.

5. OPERATION

5.1 CONTROL PANEL AND DISPLAY

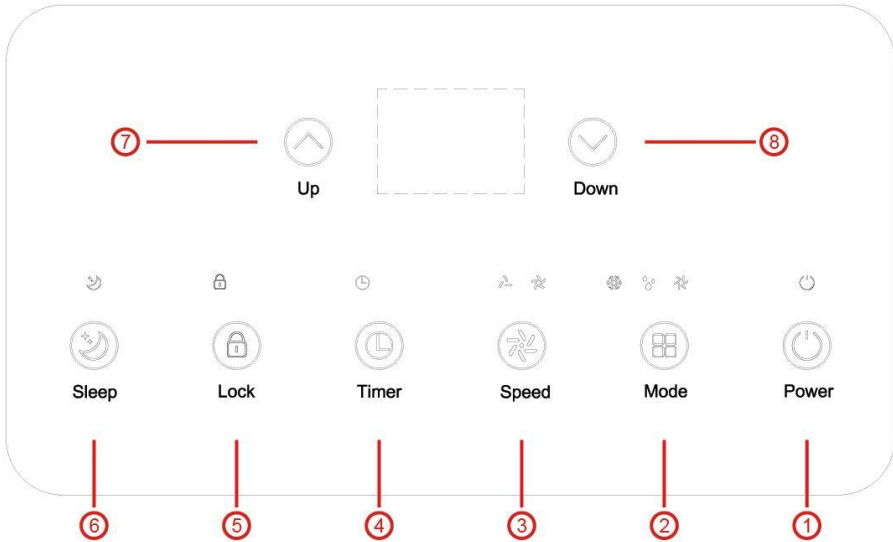

| | | |
|----------|--------------|---|
| 1 | POWER | Press to switch the machine on or off. |
| 2 | MODE | Press to switch the operation mode among cooling, fan and dehumidifier. |
| 3 | SPEED | Press to switch the fan speed between HIGH and LOW |
| 4 | TIMER | Sets a time for the unit to automatically start or stop. |
| 5 | LOCK | Long press to turn on or turn off the child lock function. |
| 6 | SLEEP | Press to turn on sleep mode or off. |
| 7 | UP | Increasing the desired temperature(61°F – 90°F)or timer setting. |
| 8 | DOWN | Decreasing the desired temperature or timer setting. |

5.2 REMOTE CONTROL

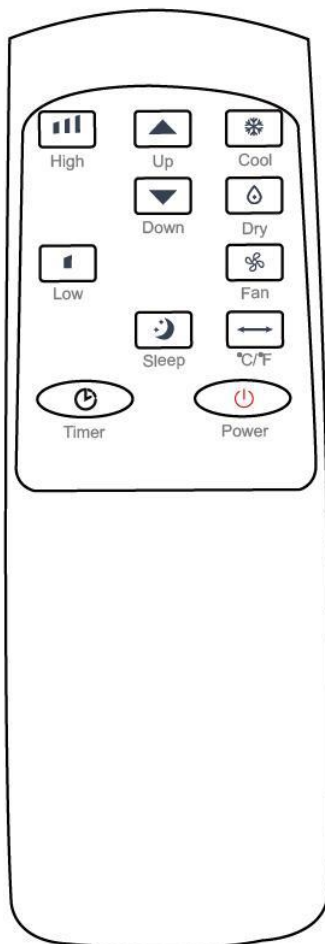

5.3 SETTINGS

5.3.1 Start-up and Shutdown

- ⇒ Press POWER to turn on the unit.
- ⇒ Press MODE button to select the desired operation mode.
- ⇒ Press POWER again to turn off the power.

5.3.2 Operation mode

The unit has four operation modes: Cool, dehumidifier, fan, sleep.
The unit working temperature under cooling mode is 61°F -95°F.

A. Cooling your room

Select the cool mode to lower the temperature in your room.

- ⇒ Press MODE button repeatedly until the COOL indicator lights up.
- ⇒ Press Up/Down button to adjust the temperature which is displayed on the screen. The temperature can be set between 61°F and 90°F.
- ⇒ Press SPEED button repeatedly until the desired fan speed indicator lights up.

To control the direction of the air flow horizontally, please adjust the inner louver by hand.

Note: The air conditioner stops if the room temperature is lower than selected temperature.

B. Ventilating your room

- ⇒ Press MODE button repeatedly until the FAN indicator lights up.
In ventilation mode the room air is circulated, but not cooled.
- ⇒ Press SPEED button repeatedly to select the fan speed as desired.

C. Drying your room

- ⇒ Press the MODE button on the control panel or remote control, and the dry indicator lights up. The fan speed is unable to be selected. The user should connect the hose to the drain outlet at the bottom of the unit.
Note: In this mode, the fan speed switches over to low speed and cannot be selected.

D. Sleep mode (this function can only be used with remote control)

The sleep mode can be activated when in cool mode.

■ In cool mode :

After 1 hour the preset temperature is increased by 2°F, after another hour the preset temperature will again be increased by 2°F.

5.3.3 TIMER SETTING (1hour-24hours) :

The timer has two ways of operation:

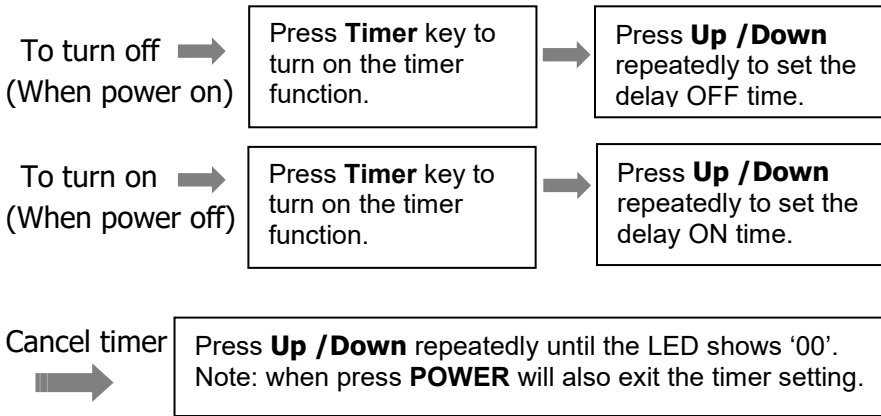

5.3.4 Automatic Defrost

At low room temperatures, frost may buildup at the evaporator during operation. The unit will automatically start defrosting and the **POWER** LED will blink. The defrost control sequence is as follows:

- A. When the unit operates in the cooling and drying operation, and the ambient temperature sensor senses the evaporator coil temperature is below 30°F, after the compressor will stop operating for 10 minutes or the coil temperature up to 44°F, the unit restart to cool operating mode.
- B. When the unit operates in the drying operation, once the coil temperature sensor senses the temperature of the evaporator is below 104°F and the differential temperature between coil temperature and room temperature is below 66°F after the compressor operation for 20minutes, the unit start defrosting for 5 minutes and the power indicator blinks.

5.3.5 Overload Protection

In the event of a power loss, there is a 3-minute delay to protect the compressor before it restarts.

5.4 DRAINAGE

Manual drainage:

1) When the machine stops after the water is full, please unplug the power plug.

Notes: Please move the machine carefully, so as not to spill the water in the water pan at the bottom of the body.

2) Place the water container below the side water outlet behind the body.

3) Unplug the water plug, the water will automatically flow into the water container.

Notes:

1. Keep the water plug properly.

2. During drainage, the body can be tilted slightly backward.

3. If the water container cannot hold all the water, before the water container is full, stuff the water outlet with the water plug as soon as possible to prevent water from flowing to the floor or the carpet.

4) When the water is discharged, stuff the water plug.

Notes: 1. Restart the machine after the water plug and drainage cover are installed, otherwise condensate water of the machine will flow to the floor or the carpet.

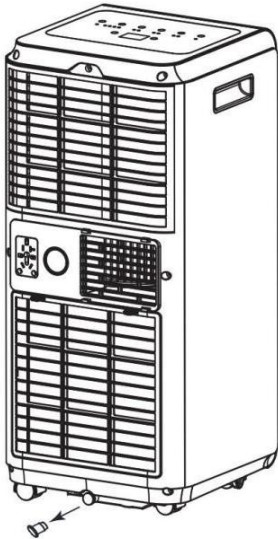

Continuous drainage

The self-evaporating system uses the collected water to cool the condenser coils for better efficient performance. It is no need to empty the drainage tank in cooling operation except in drying operation and high humidity conditions. The condensate water evaporates at the condenser and is evacuated through the exhaust hose.

For continuous operation or unattended operation in drying operation, please connect the attached drain hose to the unit. Condensate water can automatically flow into a bucket or drain by gravity.

- Switch off the unit before operating.
- Remove the plug of the water outlet opening, and keep it in a safe area.
- Securely and properly connect the drain hose and make sure it is not kinked and clear of obstruction.
- Place the outlet of the hose over a drain or bucket and ensure that water could freely flow out of the unit.
- Do not submerge the end of the hose into water; otherwise it can cause an "Air Lock" in the hose.

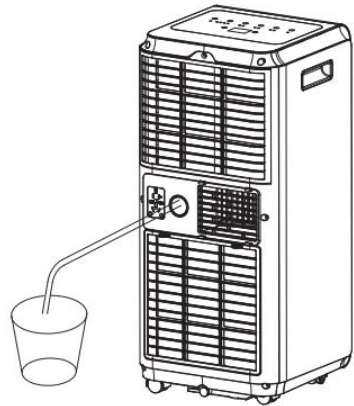

To avoid water spillage:

- As the negative pressure of the condensate drain pan is large, tilt the drain hose downward toward the floor. It is appropriate that the degree of inclination should exceed 20 degrees.
- Straighten the hose to avoid a trap existing in the hose.

6. CLEANING AND CARE

6.1. CLEANING THE AIR FILTER (every two weeks)

Dust collects on the filter and restricts the airflow. The restricted airflow reduces the efficiency of the system and if it becomes blocked it can cause damage to the unit.

The air filter requires regular cleaning. The air filter is removable for easy cleaning. Do not operate the unit without an air filter, or the evaporator may be contaminated.

1. Press POWER button to switch off the unit and unplug the power cord.
2. Remove the filter mesh from the unit.
3. Use a vacuum cleaner to suck dust from the filter.
4. Turn the filter over and rinse the air filter under running water. Let the water run through the filter in the opposite direction of air flow. Set aside and allow the filter to air dry completely before reinstalling.

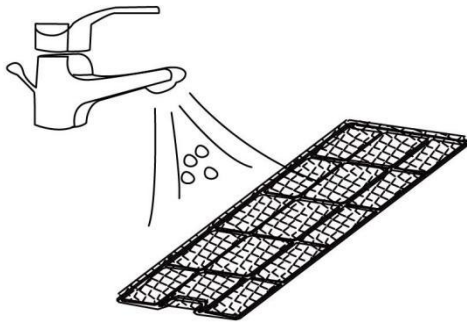

Switch off the unit and remove the air filters.

Rinse the air filter under the running water.

Warning!!!

Do not touch the evaporator surface with bare-hand, or could cause injury to your fingers.

6.2. CLEANING UP OF REFRIGERANT

General Measures:

1. Gas/vapor heavier than air. May accumulate in confined spaces, particularly at or below ground level.
2. Eliminate every possible source of ignition.
3. Use appropriate personal protection equipment (PPE).
4. Evacuate unnecessary personnel, isolate, and ventilate area.
5. Do not get in the eyes, on the skin, or clothing. Do not breathe vapors or gas.
6. Prevent entry to sewers and public waters.
7. Stop the source of the release, if safe to do so. Consider the use of water spray to disperse vapors.
8. Isolate the area until the gas has dispersed. Ventilate and gas test area before entering. Contact competent authorities after a spill.

7. TROUBLESHOOTING

| Symptom | | Inspection | Solution |
|---------------------------------------|----|--|---|
| The unit is not operating. | | ✓ Check the power connection in securely. | ➤ Insert the power cord securely into the wallOutlet. |
| | | ✓ Check if the water level indicator lights up? | ➤ Empty the drain pan by removing the rubber plug. |
| | | ✓ Check the room temperature. | ➤ The range of operating temperature is 41–95°F. |
| The unit works with reduced capacity. | | ✓ Check the air filter for dirt. | ➤ Clean the air filter as necessary. |
| | | ✓ Check if the air duct is blocked. | ➤ To clear the obstacle. |
| | | ✓ Check if the room door or window is open. | ➤ Keep the door and windows closed. |
| | | ✓ Check if the desired operating mode is selected and the temperature is properly set. | ➤ Set the mode and temperature at proper set-point according to the manual. |
| | | ✓ The exhaust hose is detached. | ➤ Make sure the exhaust hose is securely attached. |
| Water Leakage | | ✓ Overflow while moving the unit. | ➤ Empty the water tank before transport. |
| | | ✓ Check if the drain hose is kinked or bends. | ➤ Straighten the hose to avoid a trap existing. |
| Excessive Noise | | ✓ Check if the unit is securely positioned. | ➤ Place the unit on horizontal and firm ground. |
| | | ✓ Check if any loose, vibrating parts. | ➤ Secure and tighten the parts. |
| | | ✓ The noise sounds like water flowing. | ➤ Noise comes from flowing refrigerant. This is normal. |
| Error Codes | E0 | ✓ Communication faults between the main PCB and display PCB. | ➤ Check the wire harness of the display PCB for damage. |
| | E1 | ✓ Ambient temperature sensor failure | ➤ Check the connection or replace it. To clean or replace the temperature sensor. |
| | E2 | ✓ Coil temperature sensor failures. | ➤ Check the connection or replace it. To clean or replace the temperature sensor. |
| | Ft | ✓ Condensate water high level alarm. | ➤ Empty the drain pan by removing the rubber plug. |

8.1. STORAGE

Long-Term Storage - If you will not be using the unit for an extended period of time (more than a few weeks) it is best to clean the unit and dry it out completely. Please store the unit per the following steps:

1. Unplug the unit and remove the exhaust hose and window kit stored with the unit.
2. Drain the remaining water from the unit.
3. Clean the filter and let the filter dry completely in a shaded area.
4. Re-install the filter at its position.
5. The unit must be kept in upright position when in storage.
6. Preserving the machine in ventilating, dry, non- corrosive gas and safe place indoor.

ATTENTION:

The evaporator inside the machine has to be dried out before the unit is packed to avoid component damage and molds. Unplug the unit and place it in a dry open area for days to dry it out. Another way to dry the unit is to turn on the machine, adjust it to low-wind ventilation mode, and maintain this state until the drainage pipe becomes dry, so as to keep the inside of the body in a dry state and prevent it from mildewing.

8.2. DISPOSAL



WARNING!!!

Releasing refrigerant into the atmosphere is strictly forbidden!

Do not dispose of electrical appliances as unsorted municipal waste, use separate collection facilities. Contact your local government for information regarding the collection systems available. If electrical appliances are disposed of in landfills or dumps, hazardous substances can leak into the groundwater and get into the food chain damaging your health and well-being.



Thank you for purchasing this product! If you have any questions about the product, such as missing parts, damaged products, product assembling, and operation, please contact us via **Amazon Message** or customer service number: **213-4467172 or 661-4358826**.

IMPORTANT

Please call our customer service department for any consulting:

213-4467172

661-4358826

(8:30am - 5:30pm P.S.T.)

DATED PROOF OF PURCHASE IS REQUIRED FOR WARRANTY SERVICE.

AVIS

Veuillez appeler le service à la clientèle pour toutes questions au:

213-4467172

661-4358826

(8:30am - 5:30pm P.S.T.)

PREUVE D'ACHAT ORIGINALE REQUISE POUR SERVICE DE GARANTIE.

IMPORTANTE

Sólo hay que llamar nuestro departamento de servicio al cliente en caso de tener preguntas o inquietudes:

213-4467172

661-4358826

(8:30am - 5:30pm P.S.T.)

SE REQUIERE PRUEBA DE COMPRA CON FECHA PARA SERVICIO BAJO GARANTÍA.

**Address: ROWAN ELECTRIC APPLIANCE LLC
28407 Ascent Way, Santa Clarita, CA 91350
Phone: 213-4467172 or 661-4358826**

