

Industrial Pipe Clothing Racks

Basic 02

Instruction Manual

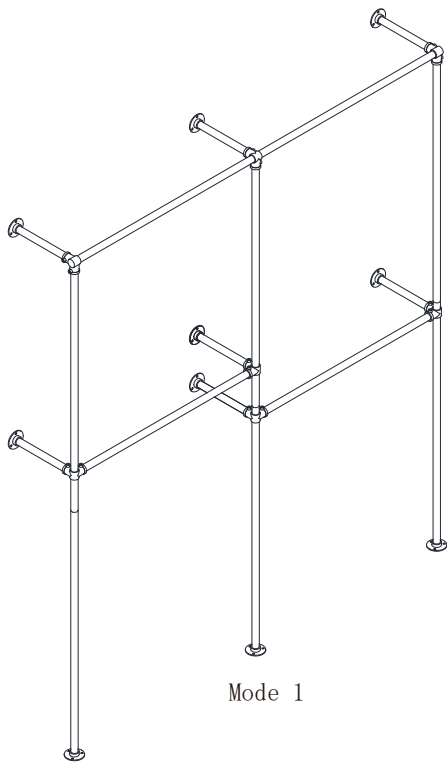

Mode 1

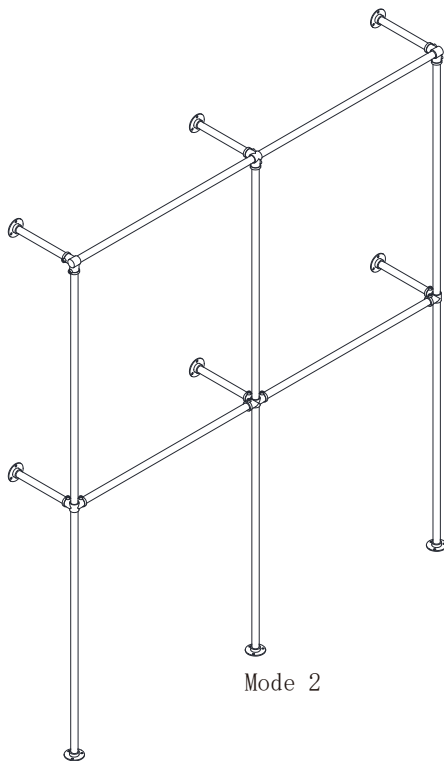













Mode 2

Customer Service Email: help@EverythingSupport.com

PARTS LIST

- Carefully remove all the parts from the carton and place them individually on a soft cloth to prevent scratches or other damage.
- Carefully and strictly follow these assembly&installation instructions to ensure a completed product as designed.
- Do not tighten all the screws until each part is properly assembled.

Number	Parts	Quantity
A		10PCS
B		2PCS
C		5PCS
D		1PC
E	 1032mm	3PCS
F	 1032mm	3PCS
G	 265mm	7PCS
H		4PCS
I	 895mm	2PCS
J	 852mm	2PCS



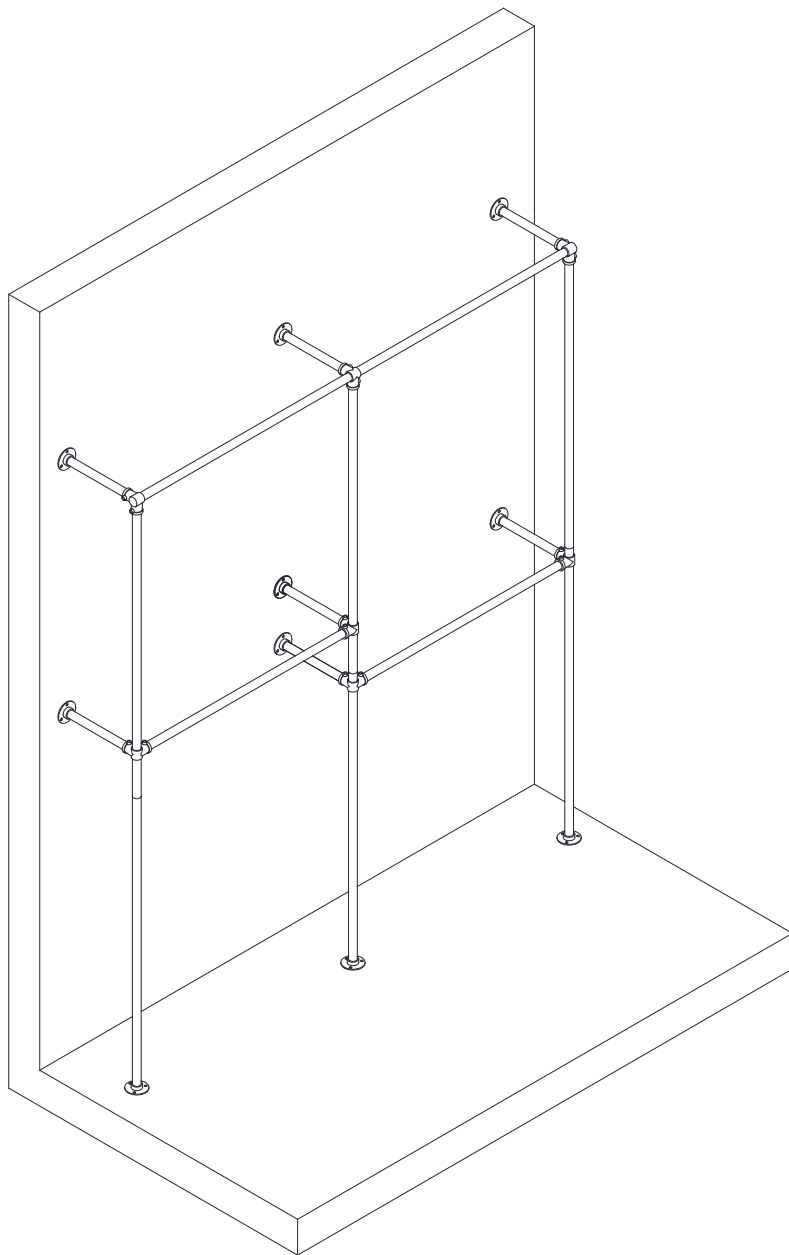

Number	Parts	Quantity
①	 M4	1PC
②	 M6*40	30PCS
③		30PCS

Note:Pages 2-7 are for Mode 1 installation instructions, and pages 8-13 are for Mode 2 installation instructions. Select the corresponding model and installation instructions according to your needs

Mode 1 installation completed



STEP 1

Required Tools	E		3PCS
	F		3PCS
	H		4PCS
	I		2PCS

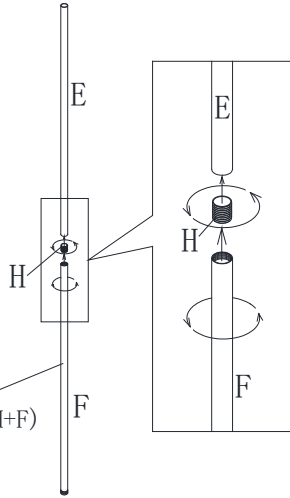



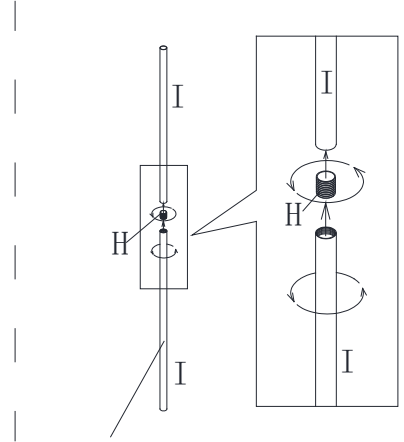

Install three sets (E+H+F)



Install one set (I+H+I)

STEP 2

Required Tools	A		7PCS
	B		2PCS
	C		5PCS
	E		7PCS
	①		1PC

A+G+B (convex dot facing right) = R(A+G+B)

A+G+B (convex dot facing left) = L(A+G+B)

A+G+C (convex dot facing right) = R(A+G+C)

A+G+C (convex dot facing left) = L(A+G+C)

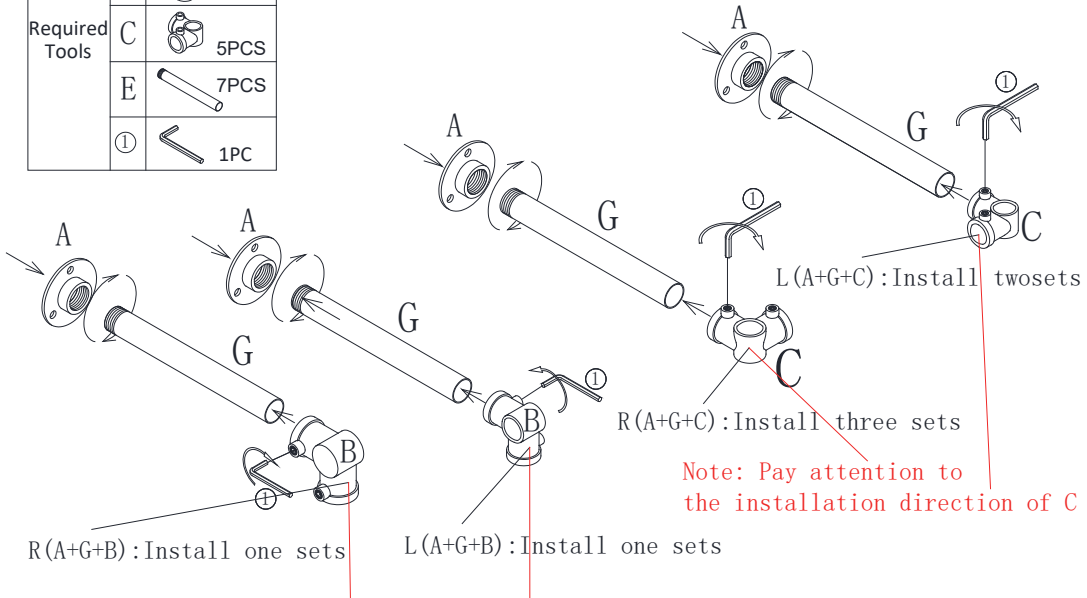

R(A+G+B): Install one sets

L(A+G+B): Install one sets

R(A+G+C): Install three sets







L(A+G+C): Install twosets

Note: Pay attention to the installation direction of C

Note: Pay attention to the installation direction of B



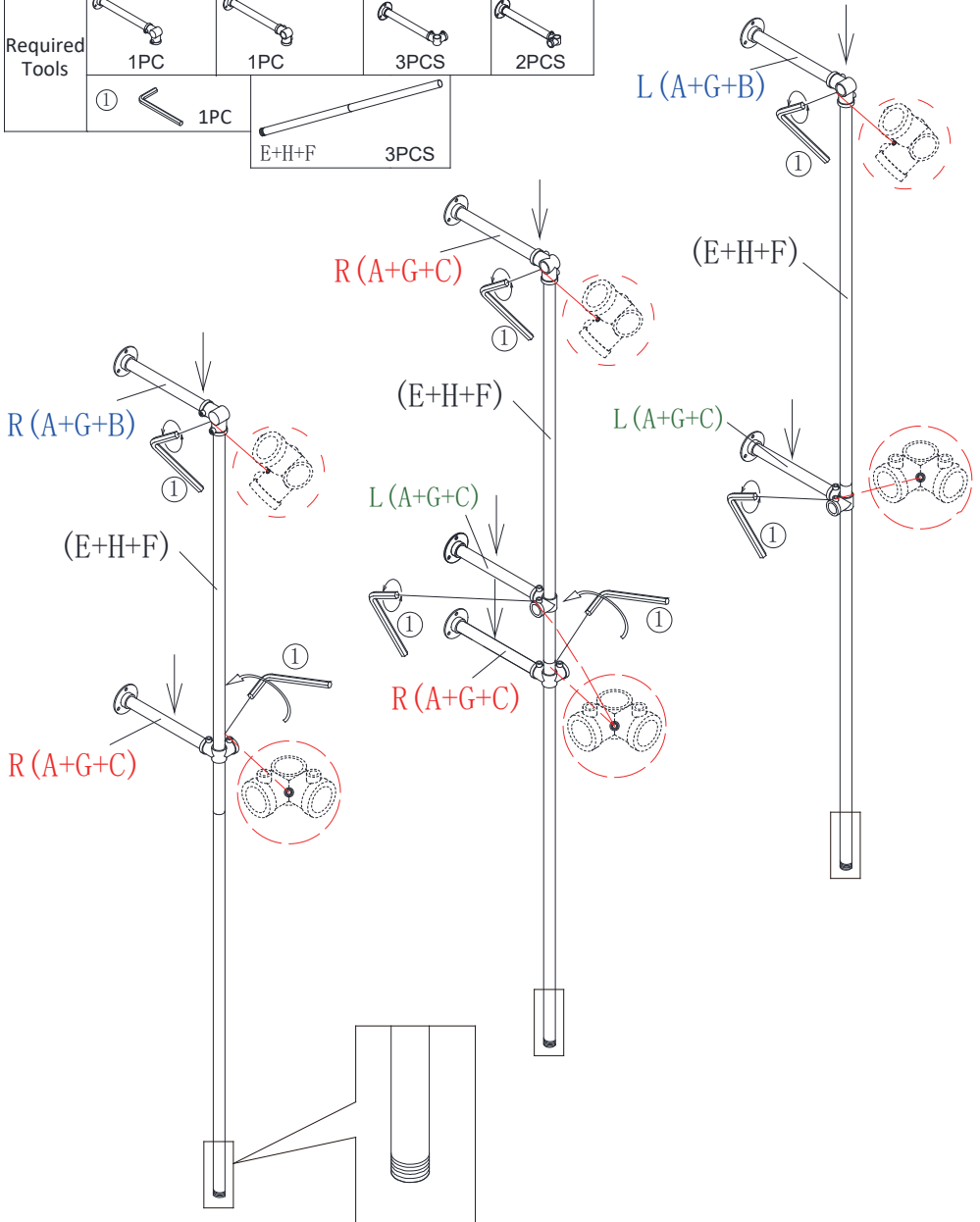

Step 3

1. Use ① to connect R(A+G+B) and E+H+F and R(A+G+C)
2. Use ① to connect R(A+G+C) and E+H+F and L(A+G+C) and R(A+G+C)
3. Use ① to connect L(A+G+B) and E+H+F and L(A+G+C)

	R(A+G+B)	L(A+G+B)	R(A+G+C)	L(A+G+C)
Required Tools	 1PC	 1PC	 3PCS	 2PCS
	①  1PC	 3PCS		



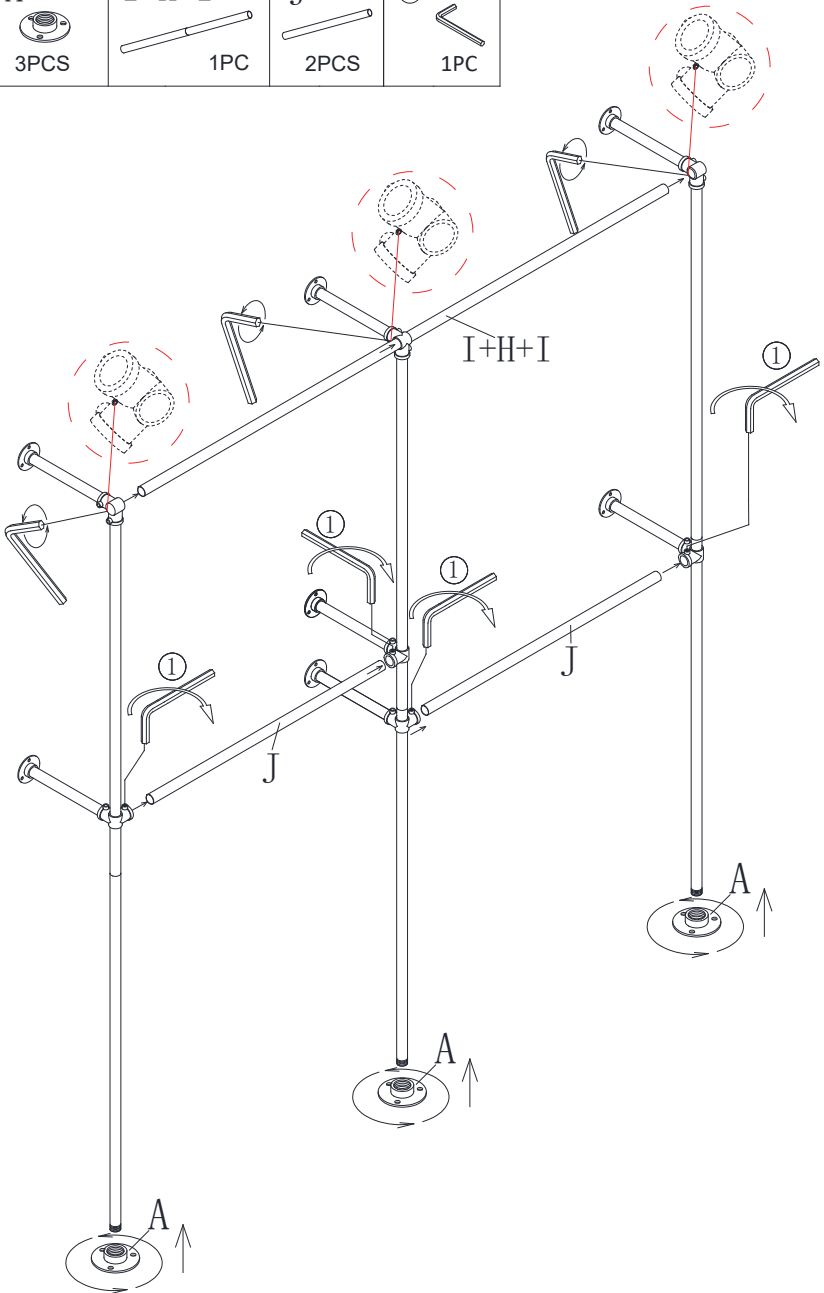

Step 4

Required Tools	A	I+H+I	J	①
	 3PCS	 1PC	 2PCS	 1PC



Step 5

Use ② and ③ nails to secure the coat rack.

水泥墙用 Required Tools	②  30PCS	③  30PCS
---------------------------	---	---

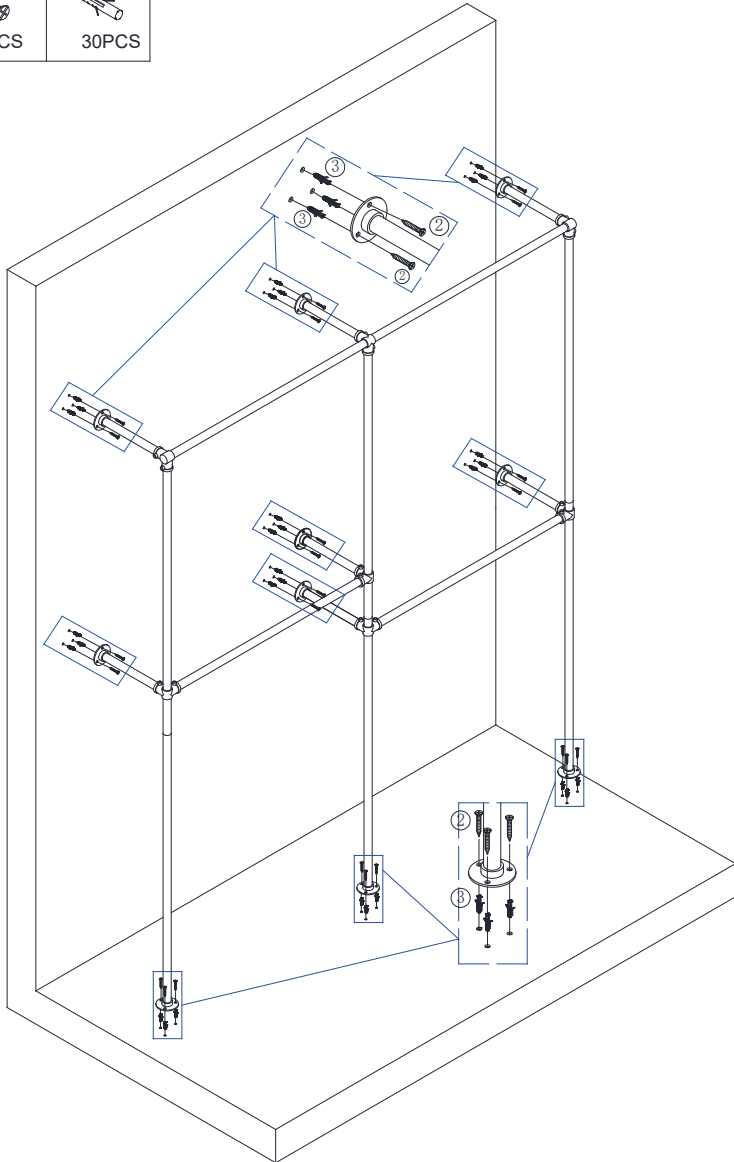



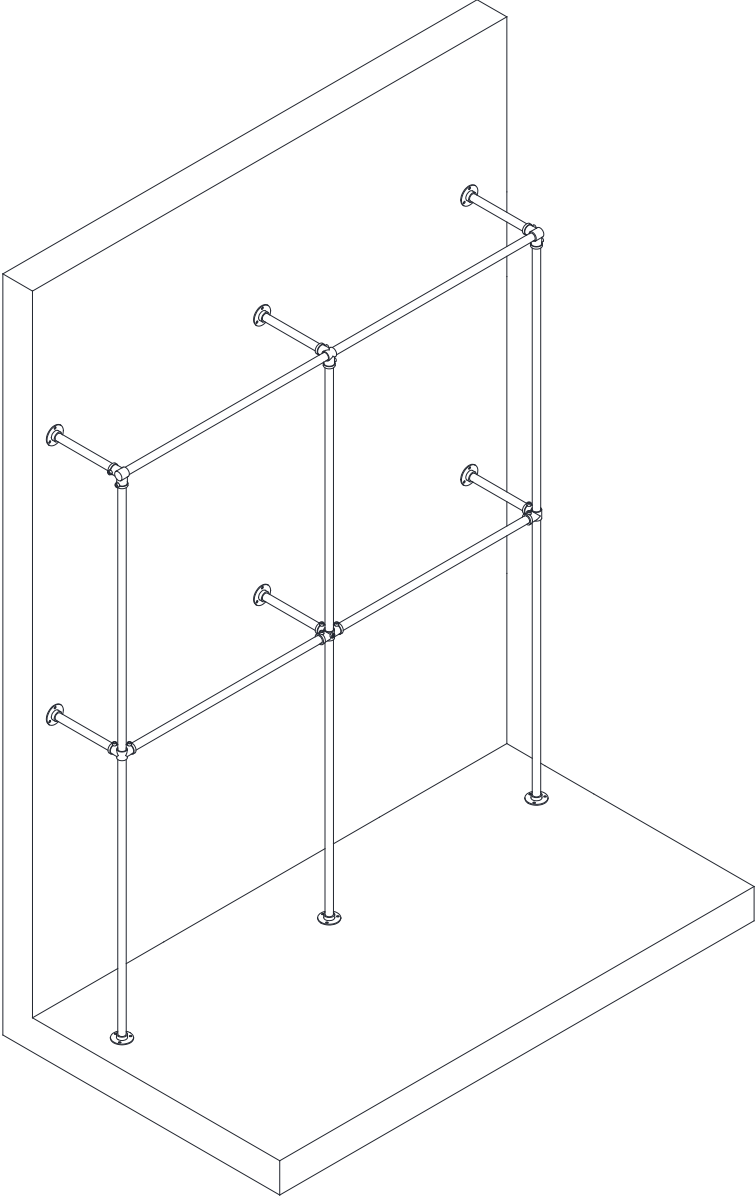

Note: Wooden wall installation can directly use ② without using ③

Mode 2 installation completed



STEP 1

Required Tools	E		3PCS
	F		3PCS
	H		4PCS
	I		2PCS

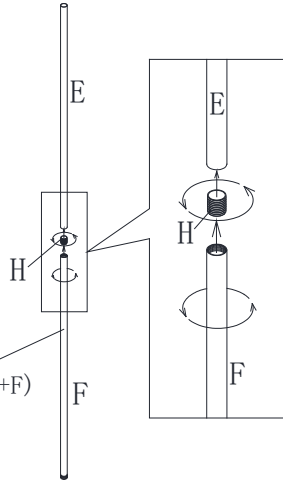



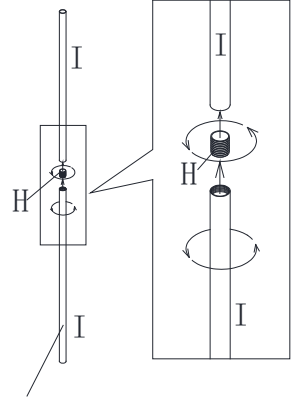



Install three sets (E+H+F)



Install one set (I+H+I)

STEP 2

Required Tools	A		6PCS	D		1PC
	B		2PCS			
	C		3PCS			
	G		6PCS			
	Ⓛ		1PC			

A+G+B(convex dot facing right) = R(A+G+B)

A+G+B(convex dot facing left) = L(A+G+B)

A+G+C(convex dot facing right) = R(A+G+C)

A+G+C(convex dot facing left) = L(A+G+C)

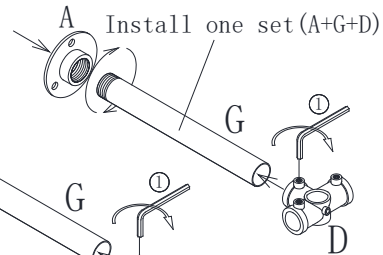

Install one set (A+G+D)

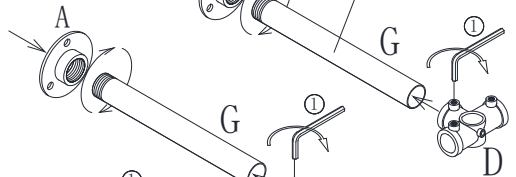

L(A+G+C): Install one sets

R(A+G+C): Install two sets

L(A+G+B): Install one sets

R(A+G+B): Install one sets

Note: Pay attention to the installation direction of C

Note: Pay attention to the installation direction of B



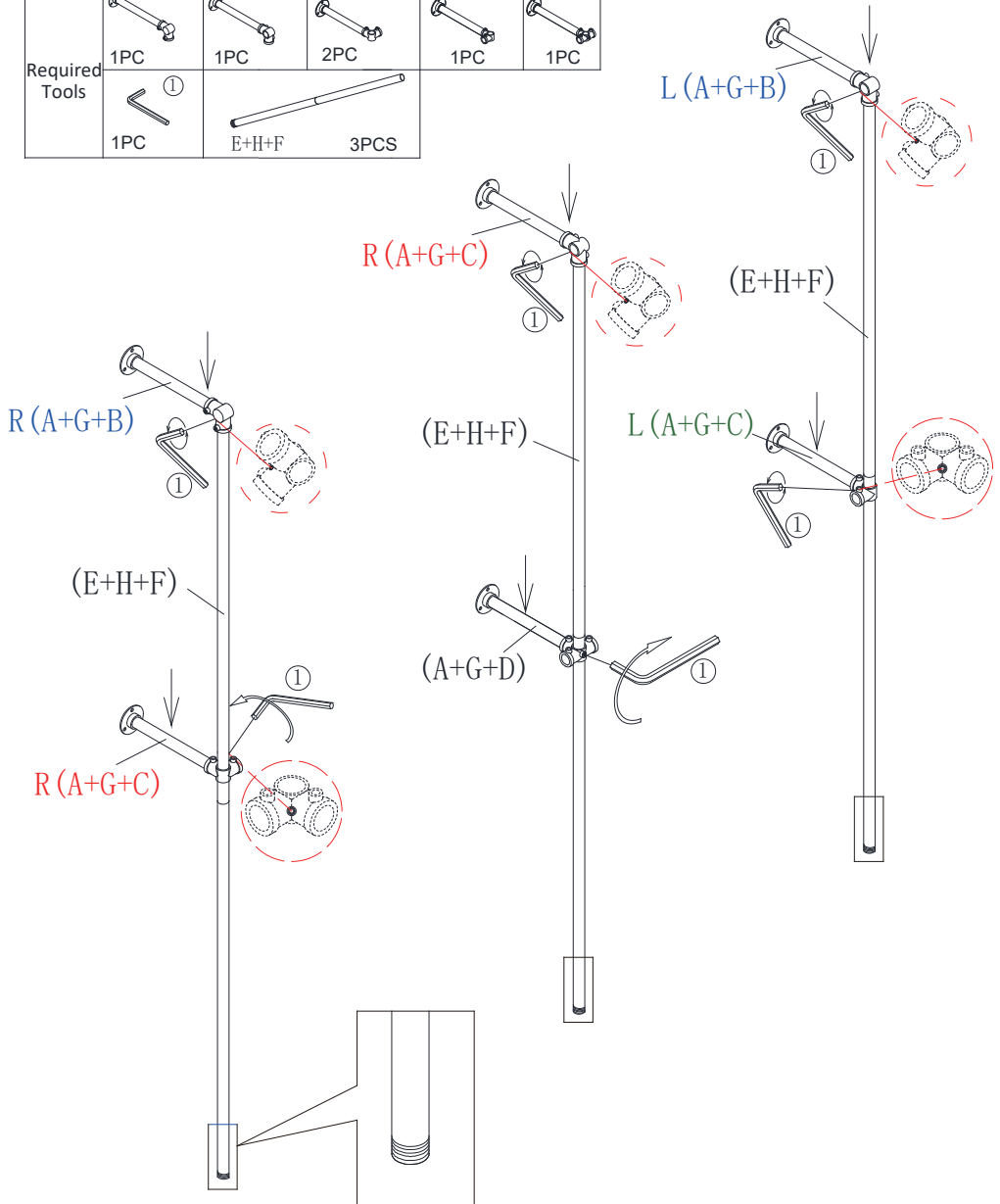

Step 3

1. Use ① to connect R(A+G+B) and (E+H+F) and R(A+G+C)
2. Use ① to connect R(A+G+C) and (E+H+F) and (A+G+D)
3. Use ① to connect L(A+G+B) and (E+H+F) and L(A+G+C)

	R(A+G+B)	L(A+G+B)	R(A+G+C)	L(A+G+C)	A+G+D
Required	1PC	1PC	2PC	1PC	1PC
Tools	①				
	1PC	E+H+F	3PCS		



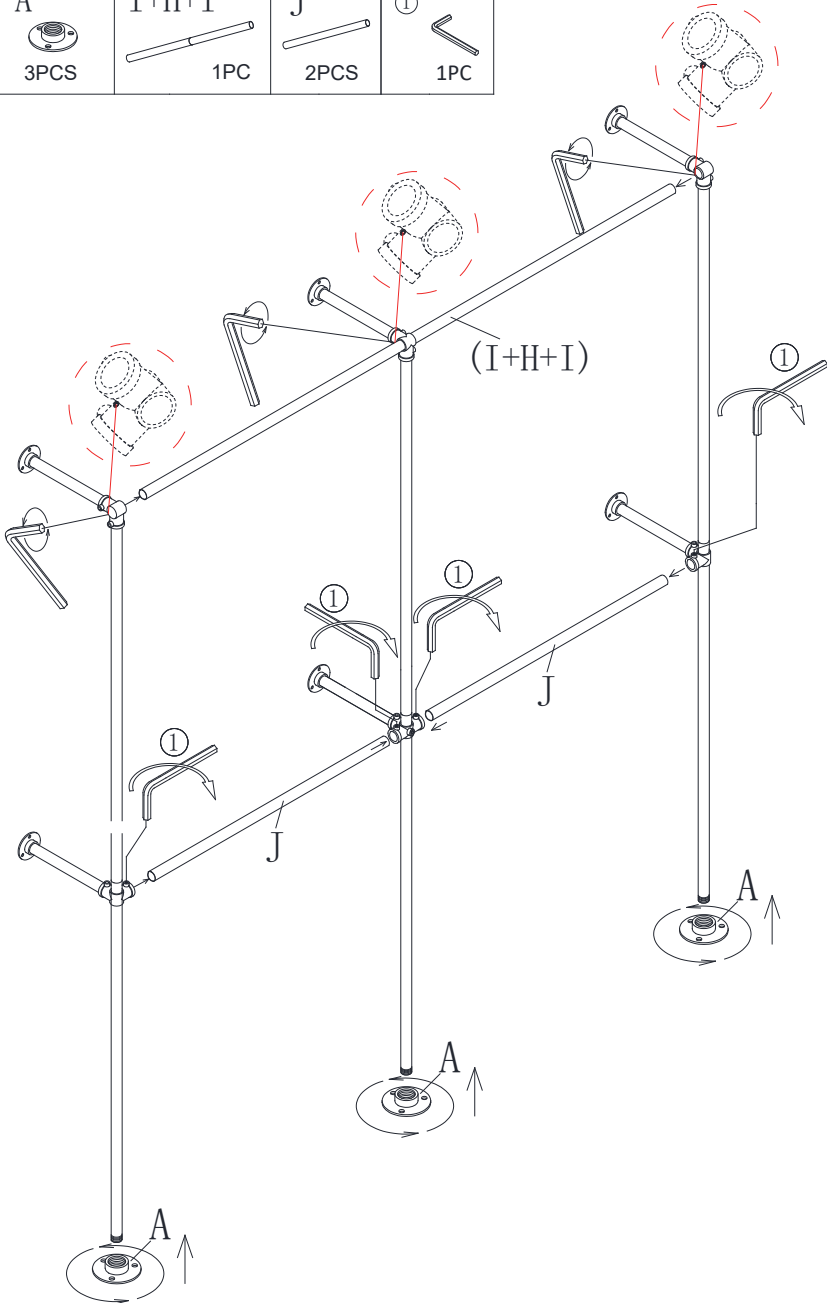

Step 4

Required Tools	A	I+H+I	J	①
	 3PCS	 1PC	 2PCS	 1PC



Step 5

Use ② and ③ nails to secure the coat rack.

Required Tools	②	③
	 27PCS	 27PCS

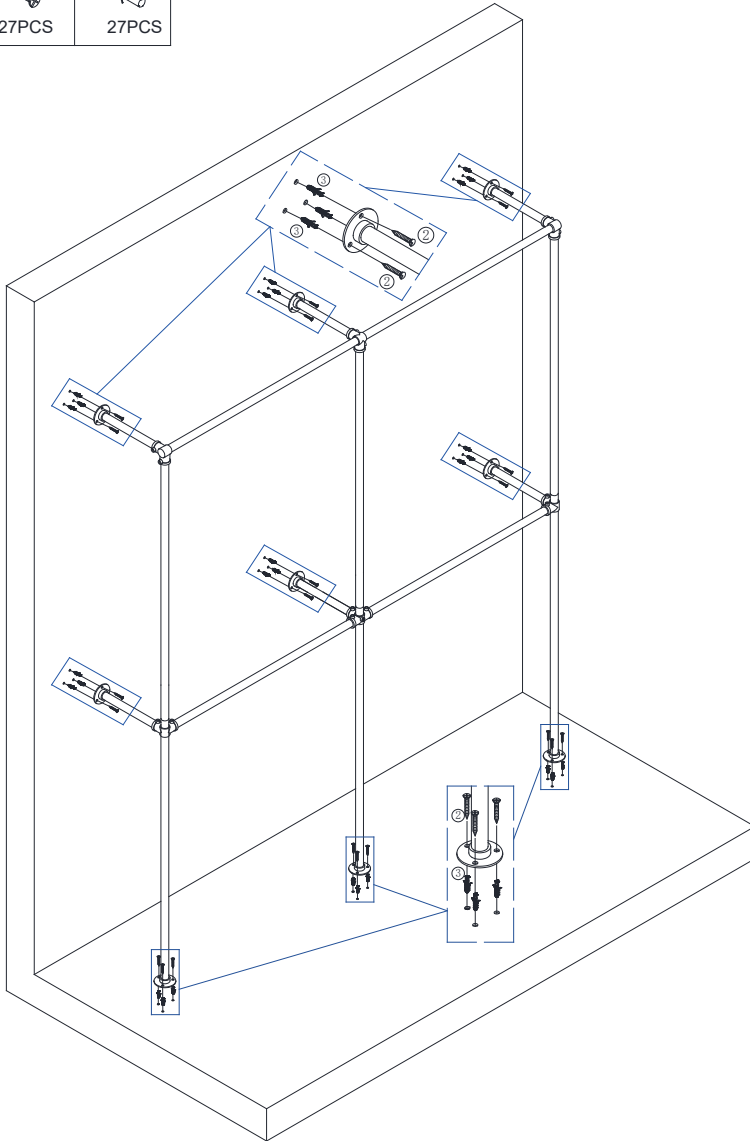

Note: Wooden wall installation can directly use ② without using ③

AFTER-SALES SERVICE CARD

We sincerely thank you for trusting our service and our products, and may this product add enrichment to your home. We guarantee that the product has undergone strict quality inspection and meticulous packaging. If you encounter any issue regarding either shipping or the product, please feel free to contact us at any time. We'd be more than happy to serve you wholeheartedly.

Yours Sincerely

Customer Service: contact help@EverythingSupport.com

Address: 3005 Breckinridge Blvd, Suite 200, Duluth, GA 30096

If you have any questions or concerns please feel free to contact us. We're committed to providing our customers with the quality service.