

HALL TREE

Assembly Instructions - Please keep for future reference

Instructions d'assemblage - s'il vous plaît garder pour référence future

N724P411811/N724P411812/N724P411813

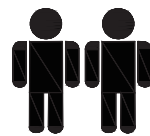
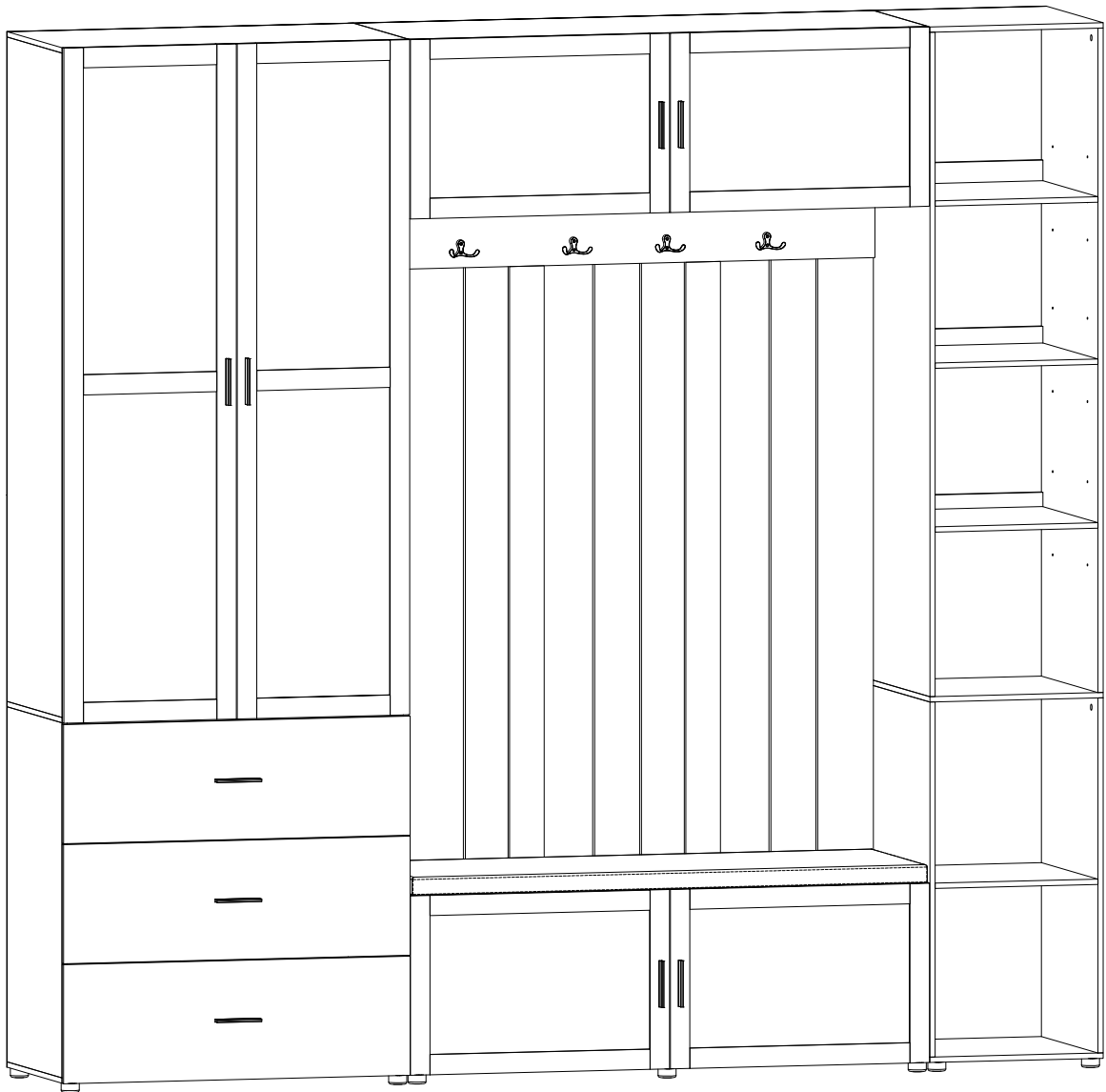

Two people are required to assemble and move this model.
Deux personnes sont nécessaires pour Assembler et déplacer ce modèle.

Important – Please read these instructions fully before starting assembly

Important - veuillez lire ces instructions complètement avant de commencer l'assemblage

Safety and Care Advice

Important – Please read these instructions fully before starting assembly

- Check you have all the components and tools listed on the following pages.
- Remove all fittings from the plastic bags and separate them
- Keep children and pets away from the installation area, which may cause choking if small parts are swallowed.
- Make sure you have enough space to layout the parts before
- Do not stand or apply weight to the product during assembly. This may cause damage.
- Assemble the item as close to its final position (in the same room) as possible.
- Assemble on a soft level surface to avoid damage to the unit or floor.
- It's easier for two people to assemble the parts together.
- To reduce the likelihood of damage to your product, make sure your power drill is set to a low torque setting.



Care and maintenance

- Only clean using a damp cloth and mild detergent, do not use bleach or abrasive cleaners.
- Check for loose screws on this unit from time to time.
- This product should not be discarded with household waste. Take to your local authority waste disposal centre.

Handy Hints

- Assemble all parts and bolts loosely during assembly, only once the product is complete should you fully tighten the bolts
- Regularly check and ensure that all bolts and fittings are correctly tightened.

WARNING In order to help prevent overturning – please follow these instructions

To help prevent product toppling over please follow the below steps:-

Use the anti tip stap or wall fixing method provided (if applicable)
Do not allow children to climb or hang on the furniture
Do not open more than one drawer at a time
Do not place heavy items in the top drawers
Do not place heavy items on top of the furniture, unless the furniture has been designed for this purpose

please note that only the anti tip strap is provided.
You will need to provide wall plugs and screws applicable for your wall type

Conseils de sécurité et de soins

Important - veuillez lire ces instructions complètement avant de commencer l'assemblage

- Vérifiez que vous avez tous les composants et outils énumérés sur les pages suivantes.
- Retirez tous les accessoires des sacs en plastique et les séparez
- Gardez les enfants et les animaux de compagnie loin de la zone d'installation, qui peut causer l'étouffement si de petites pièces sont avalées.
- Assurez-vous d'avoir suffisamment d'espace pour mettre en place les pièces avant.
- Ne pas se tenir debout ou appliquer le poids à l'unité pendant l'assemblage. Cela peut causer des dommages.
- Assemblez l'élément le plus près possible de sa position finale (dans la salle de séjour).
- Assemblez sur un niveau doux Surface pour éviter les dommages à l'unité ou à l'étage.
- Il est plus facile pour deux personnes de se réunir les parties ensemble.
- Pour réduire la probabilité de dommages à votre produit, assurez-vous que votre perceuse électrique est réglée sur un réglage de couple faible.



Entretien et entretien

- Nettoyer uniquement à l'aide d'un détergent doux à linge humide, ne pas utiliser d'eau de javel ou de nettoyeurs abrasifs
- Vérifiez les vis desserrées sur cette unité de temps en temps.
- Ce produit ne doit pas être jeté avec les ordures ménagères, emporter au centre d'élimination des déchets de votre collectivité locale

Conseils pratiques

- Assemblez toutes les pièces et les boulons de manière lâche pendant l'assemblage, serrez complètement les boulons seulement une fois le produit entièrement assemblé
- Vérifiez et assurez régulièrement que tous les boulons et raccords sont correctement serrés.

Avertissement Afin de prévenir le renversement Veuillez suivre ces instructions

Pour aider à prévenir le renversement du produit, veuillez suivre les étapes suivantes :-

Utilisez la méthode anti-tip stap ou de fixation murale fournie (le cas échéant)
Ne laissez pas les enfants grimper ou accrocher aux meubles
N'ouvrez pas plus d'un tiroir à la fois
Ne placez pas d'objets lourds dans les tiroirs supérieurs
Ne placez pas d'objets lourds sur le dessus des meubles, sauf si les meubles ont été conçus à cet effet

Veuillez noter que seule la courroie anti-pointe est fournie.

Vous devrez fournir des bouchons muraux et des vis applicables pour votre type de mur

Using Camlocks

Step 1

Connect the male camlock as directed in the assembly instructions using a screwdriver.

1 DO NOT OVER TIGHTEN.

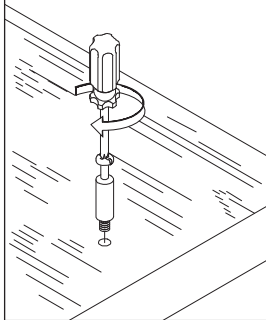

Step 2

Push the male camlock into the entry hole.

2

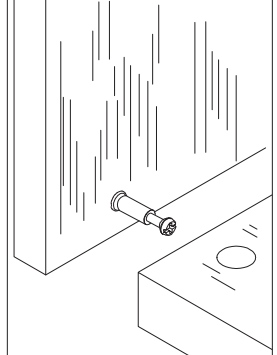

Step 3

Insert the female camlock as shown in the instruction.

Note: ensure that the arrow on the top of the camlock points towards the entry hole for the male camlock.

3

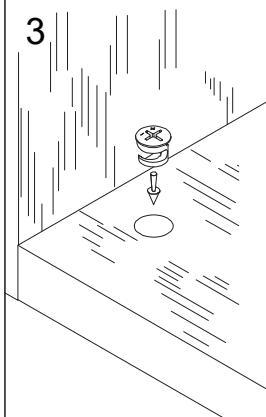

Step 4

Turn the female camlock clockwise with a screwdriver.

You should feel a click when the camlock is locked in place.

The joint is now secure.

4

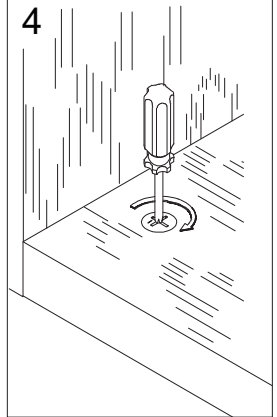

Utilisation de Camlocks

Étape 1

Connectez le mâle Camlock tel que dicté dans Les instructions de montage Utiliser un driver scwdriver.

1

Ne pas trop serrer.
NE PAS SERRER EXCESSIVEMENT.

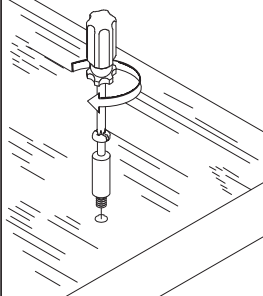

Étape 2

Poussez le camlock mâle Dans le trou d'entrée.

2

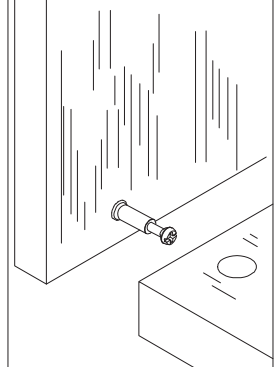

Étape 3

Insérer le femle Camlock comme indiqué dans le Instruction.

Note: assurez-vous que le Flèche sur le haut de la Camlock pointe vers Le trou d'entrée pour la Mâle camlock.

3

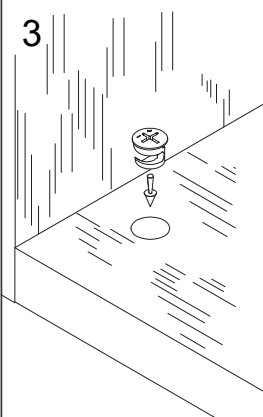

Étape 4

Tournez la femelle camlock Dans le sens horaire avec un Tournevis.

Vous devriez sentir un clic Lorsque le camlock est Verrouillé en place.

Le joint est maintenant sécurisé.

4

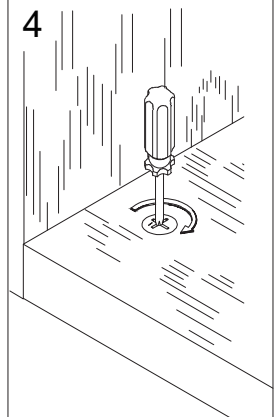

Assembly instructions / Instructions de montage

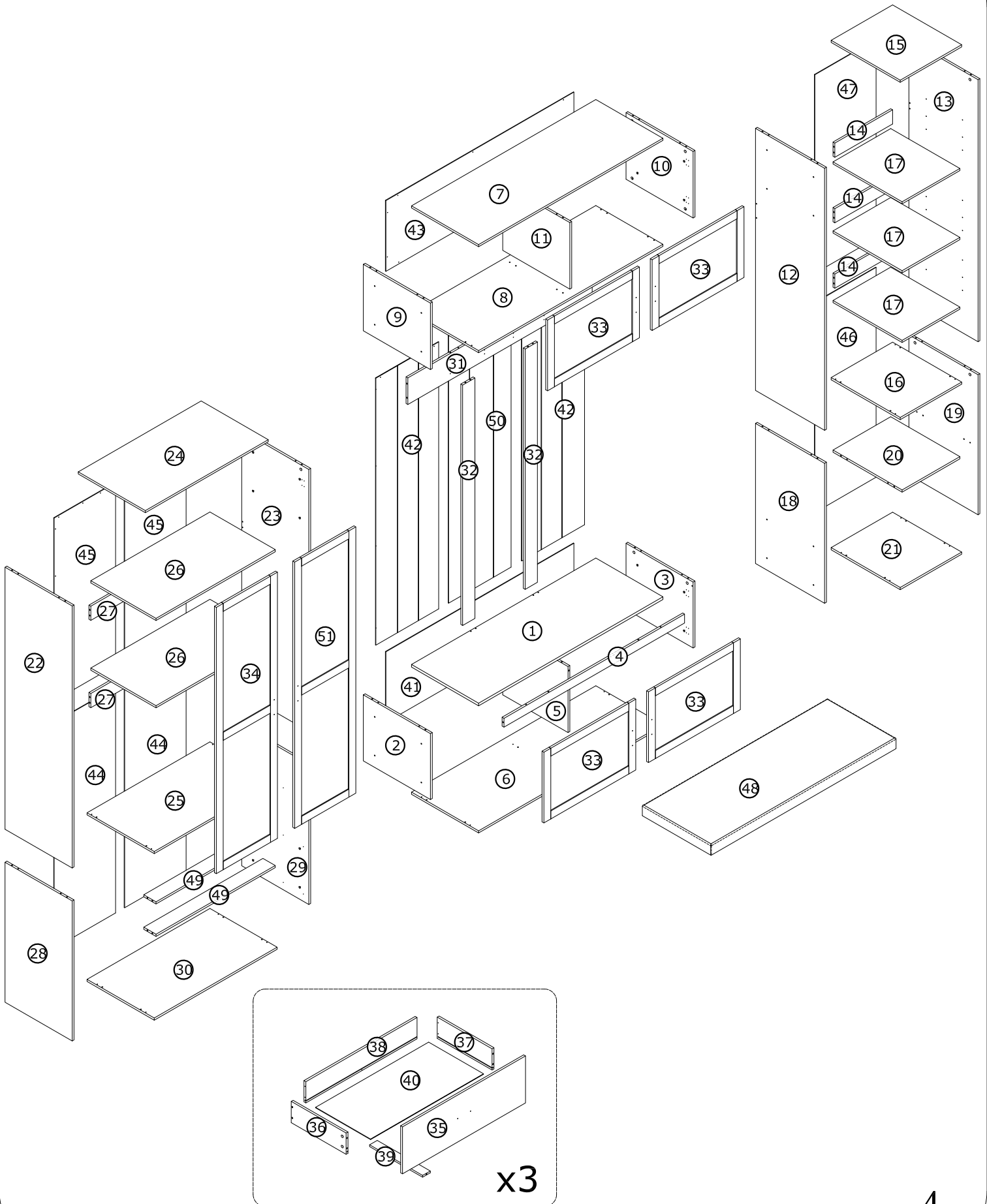

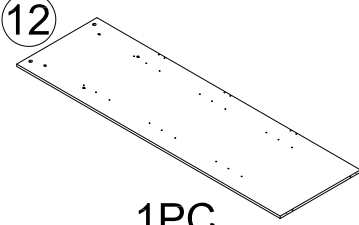
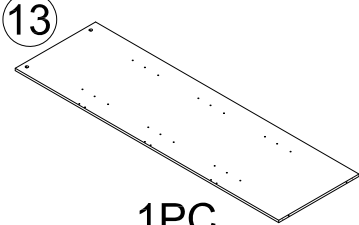
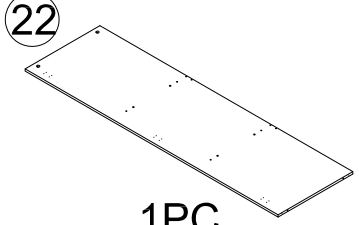
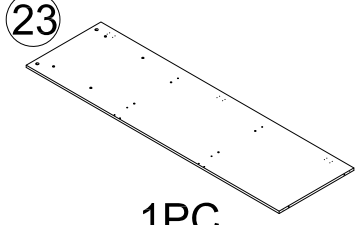
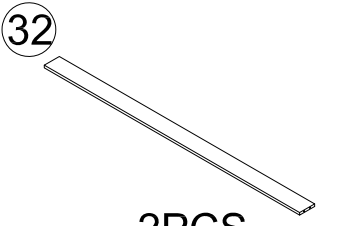
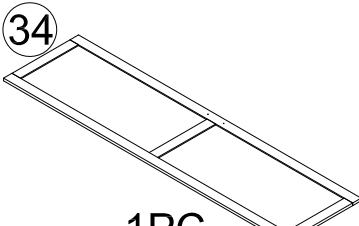
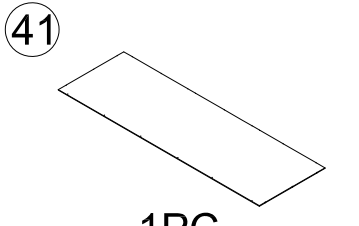
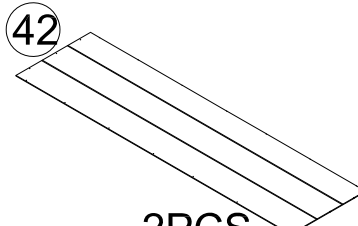
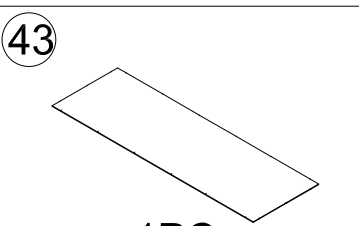
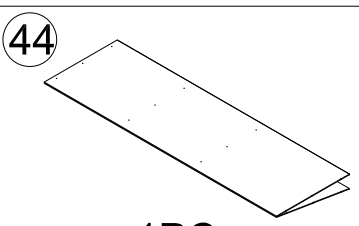
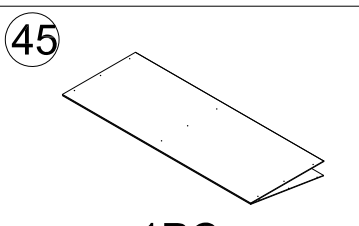
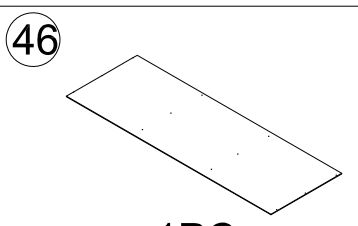
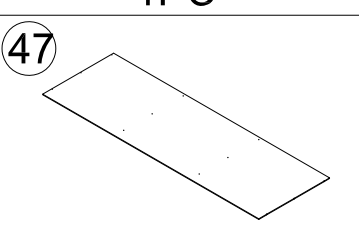
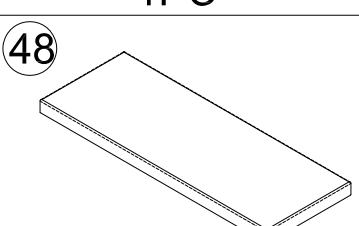
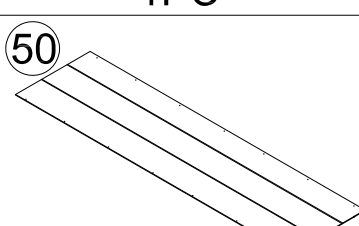
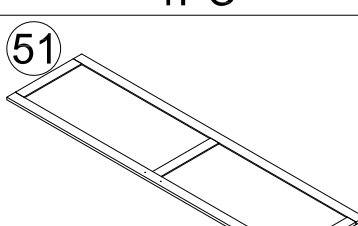
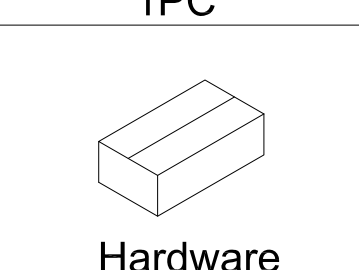

Part List / Liste des pièces

N724P411811 CARTON CONTENT/CONTENU DUCARTON

 <p>12</p> <p>1PC</p>	 <p>13</p> <p>1PC</p>	 <p>22</p> <p>1PC</p>	 <p>23</p> <p>1PC</p>
 <p>32</p> <p>2PCS</p>	 <p>34</p> <p>1PC</p>	 <p>41</p> <p>1PC</p>	 <p>42</p> <p>2PCS</p>
 <p>43</p> <p>1PC</p>	 <p>44</p> <p>1PC</p>	 <p>45</p> <p>1PC</p>	 <p>46</p> <p>1PC</p>
 <p>47</p> <p>1PC</p>	 <p>48</p> <p>1PC</p>	 <p>50</p> <p>1PC</p>	 <p>51</p> <p>1PC</p>
 <p>Hardware</p>			

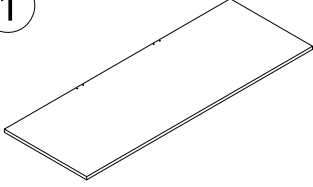
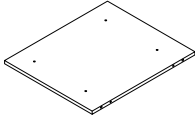
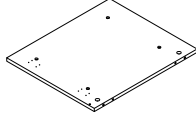
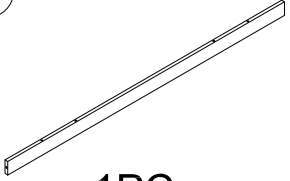
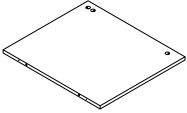
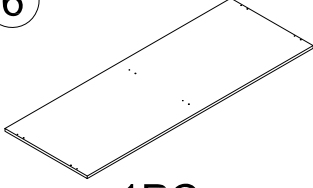
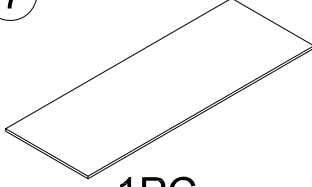
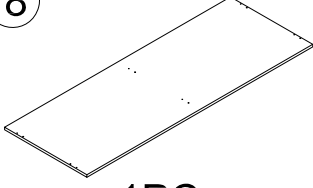
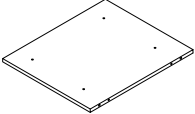
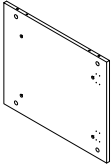
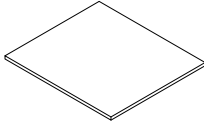
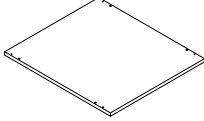
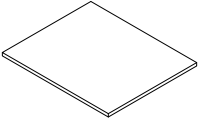
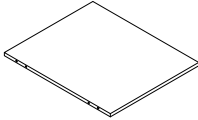
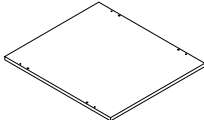
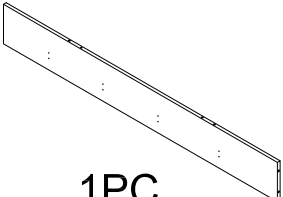
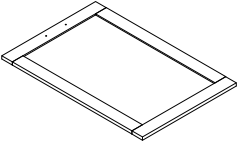

Part List / Liste des pièces

N724P411812 CARTON CONTENT/CONTENU DUCARTON

<p>①</p>  <p>1PC</p>	<p>②</p>  <p>1PC</p>	<p>③</p>  <p>1PC</p>	<p>④</p>  <p>1PC</p>
<p>⑤</p>  <p>1PC</p>	<p>⑥</p>  <p>1PC</p>	<p>⑦</p>  <p>1PC</p>	<p>⑧</p>  <p>1PC</p>
<p>⑨</p>  <p>1PC</p>	<p>⑩</p>  <p>1PC</p>	<p>⑮</p>  <p>1PC</p>	<p>⑯</p>  <p>1PC</p>
<p>⑰</p>  <p>3PCS</p>	<p>⑳</p>  <p>1PC</p>	<p>㉑</p>  <p>1PC</p>	<p>㉓</p>  <p>1PC</p>
<p>⑳</p>  <p>4PCS</p>	<p>㉙</p>  <p>3PCS</p>		

Part List / Liste des pièces

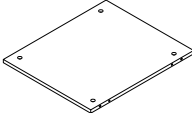
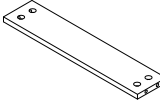
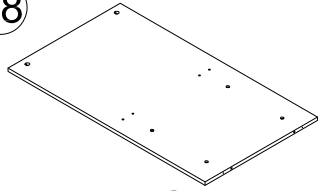
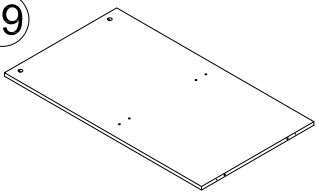
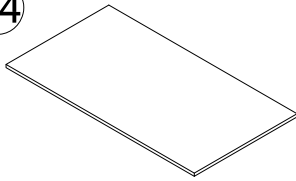
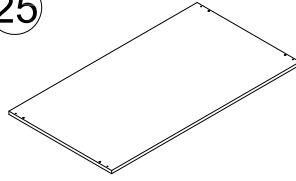
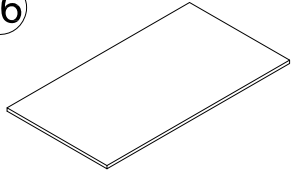
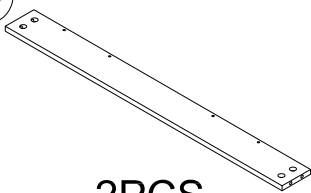
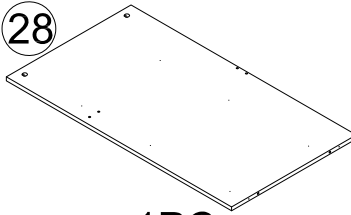
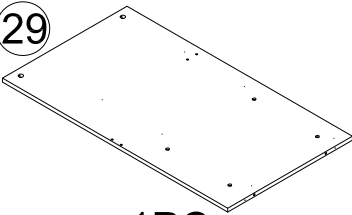
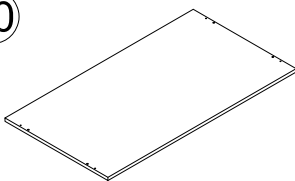
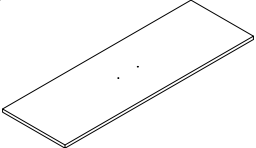
N724P411813 CARTON CONTENT/CONTENU DUCARTON

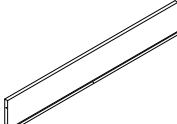
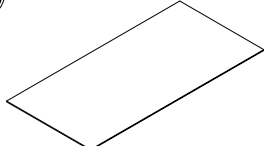
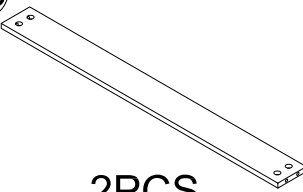
 <p>11</p> <p>1PC</p>	 <p>14</p> <p>3PCS</p>	 <p>18</p> <p>1PC</p>	 <p>19</p> <p>1PC</p>
 <p>24</p> <p>1PC</p>	 <p>25</p> <p>1PC</p>	 <p>26</p> <p>2PCS</p>	 <p>27</p> <p>2PCS</p>
 <p>28</p> <p>1PC</p>	 <p>29</p> <p>1PC</p>	 <p>30</p> <p>1PC</p>	 <p>35</p> <p>3PCS</p>
 <p>36</p> <p>3PCS</p>	 <p>37</p> <p>3PCS</p>	 <p>38</p> <p>3PCS</p>	 <p>40</p> <p>3PCS</p>
 <p>49</p> <p>2PCS</p>			

Hardware list/ Liste du matériel











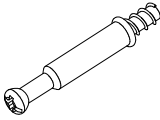
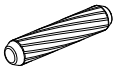

Please check you have all the panels listed below

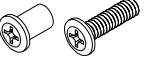
Veillez vérifier que vous avez tous les panneaux énumérés ci-dessous

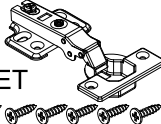
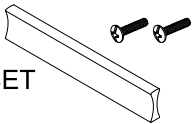
Note: The quantities below are the correct amount to complete the assembly. In some cases, more fittings may be supplied than required.

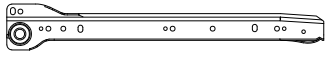
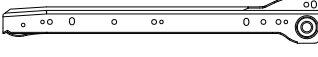
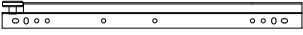
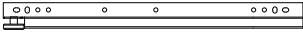
Remarque: Les quantités ci-dessous sont la quantité correcte pour compléter l'assemblage.

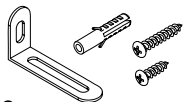
Dans certains cas, plus de raccords. Peut être fourni que sont requis.

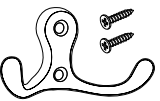
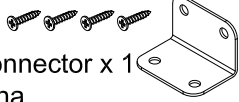
<p>A</p> <p>Male Camlock x 112 Mâle Camlock</p> 	<p>B</p> <p>6*30 Dowel x 76 6*30 Le goujon</p> 	<p>C</p> <p>Female Camlock x 112 Femelle Camlock</p> 
<p>D</p> <p>4*40mm Screw x 22 4*40mm vis</p> 	<p>E</p> <p>4*25mm Leg x 14 4*25mm Pierna</p> 	<p>F</p> <p>6*12mm Screw x 16 6*12mm vis</p> 
<p>G</p> <p>3*12mm Screw x 156 3*12mm vis</p> 	<p>H</p> <p>3.5*12mm Hinge x 14 SET 3.5*12mm Bisagras</p> 	<p>I</p> <p>4*16mm Handle x 9 SET 4*16mm ronde</p> 
<p>J</p> <p>3*12mm Screw x 30 3*12mm vis</p> 	<p>CL</p> <p>300mm Slide rail CL x 3 300mm Glissière CL</p> 	<p>CR</p> <p>300mm Slide rail CR x 3 300mm Glissière CR</p> 
<p>DL</p> <p>300mm Slide rail DL x 3 300mm Glissière DL</p> 	<p>DR</p> <p>300mm Slide rail DR x 3 300mm Glissière DR</p> 	<p>K</p> <p>Shelf support x 12 Support D'étagère</p> 
<p>L</p> <p>Wall Fixing Pack x 2 Pack de fixation murale</p> 	<p>M</p> <p>4*30mm Screw x 15 4*30mm vis</p> 	<p>N</p> <p>3*16mm Coat hook x 4 Gancho de abrigo</p> 
<p>O</p> <p>3*10mm Corner connector x 1 Conector de esquina</p> 		

Assembly Tools Required (Not Included)
Outils d'assemblage requis (Non Inclus)

Assembly instructions / Instructions de montage

Step 1

Étape 1

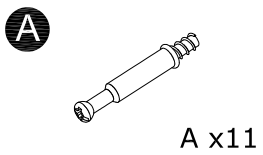
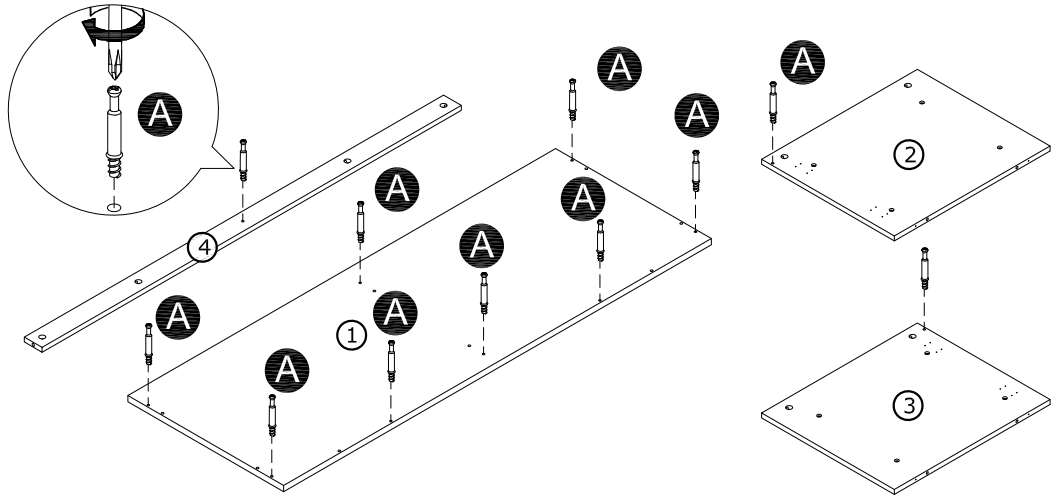
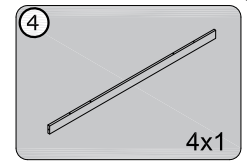
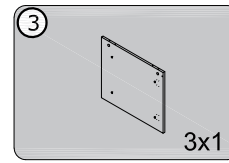
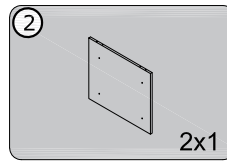
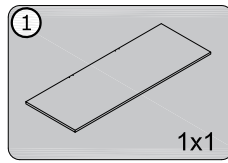

Step 2

Étape 2

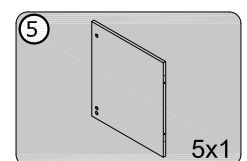
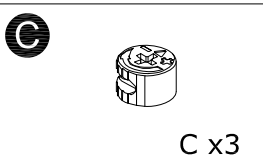
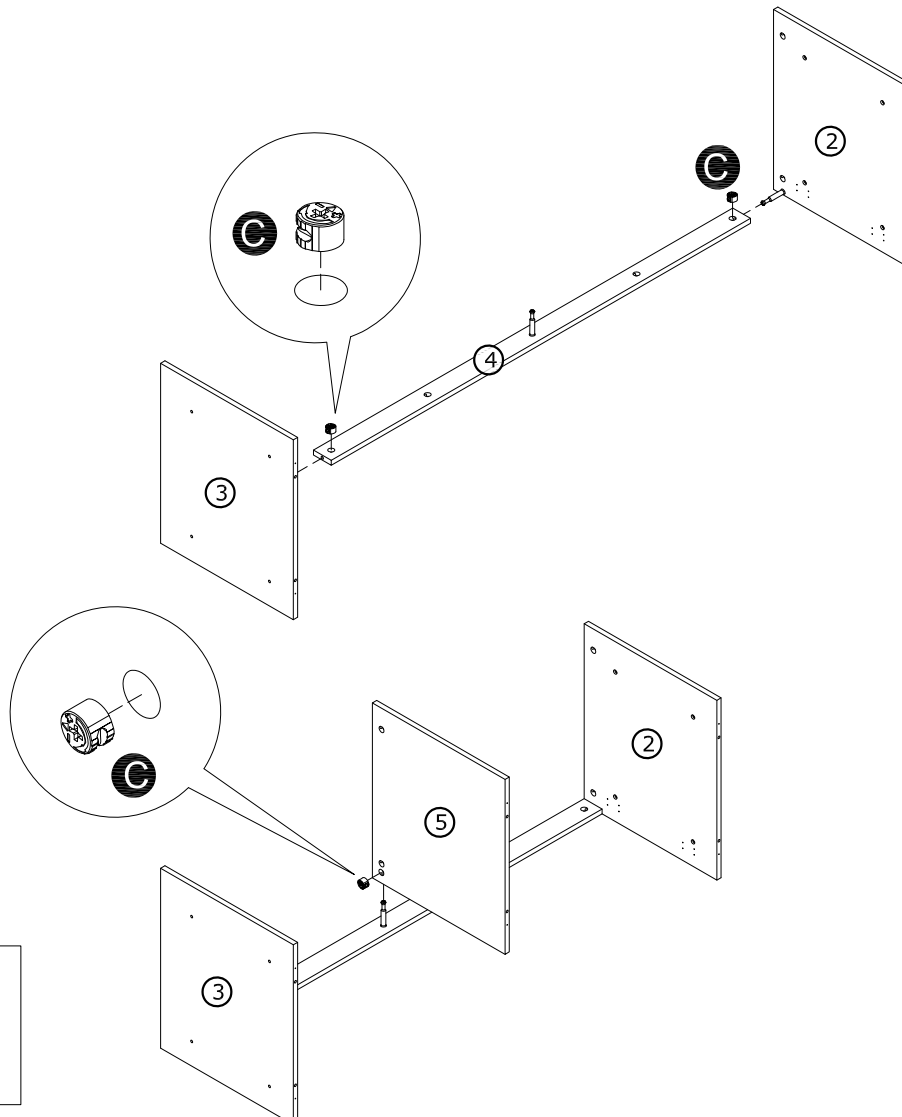

Assembly instructions / Instructions de montage

Step 3

Étape 3

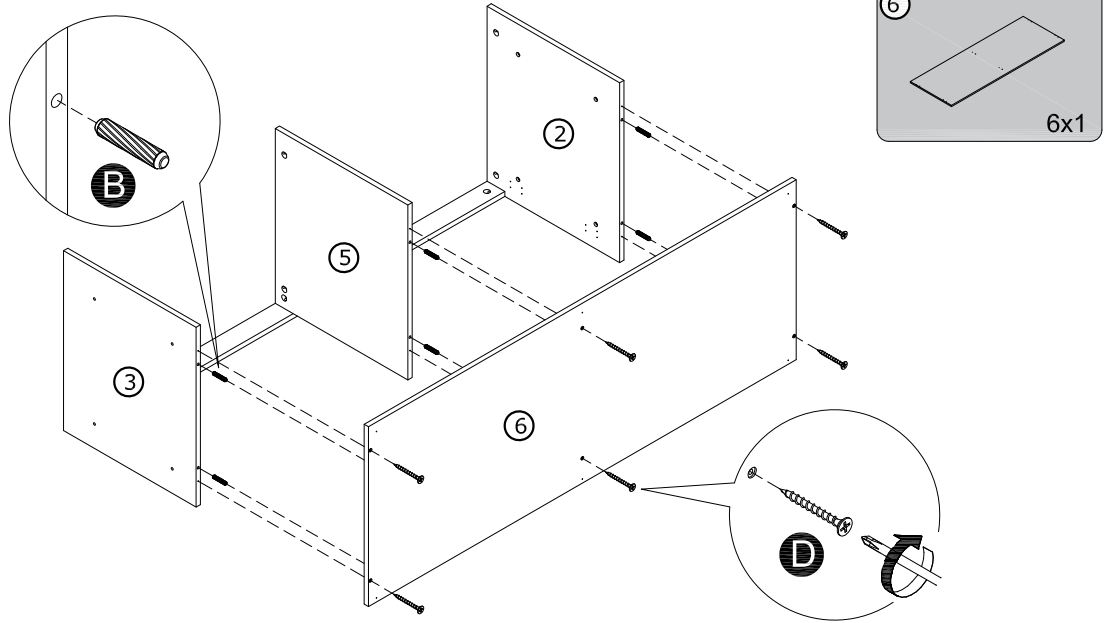

B



B x6

D



D x6

Step 4

Étape 4

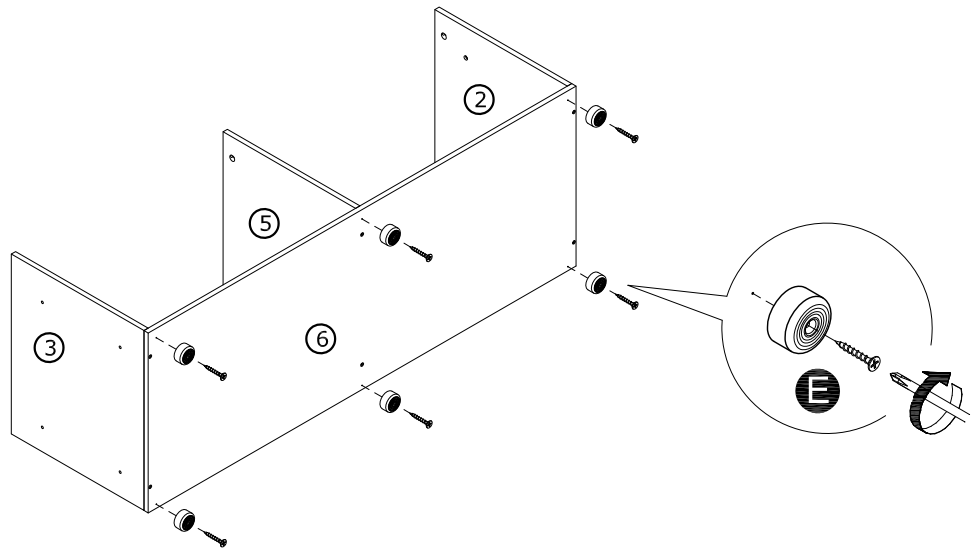

E



E x6

Step 5

Étape 5

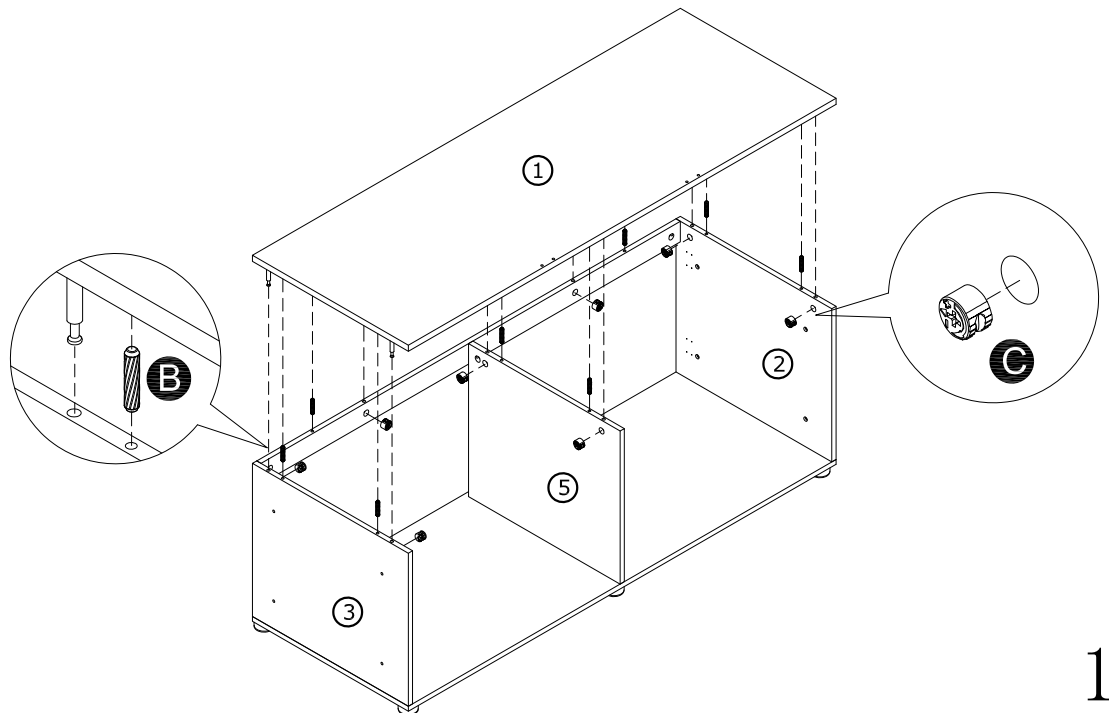

B



B x8

C



C x8

Assembly instructions / Instructions de montage

Step 6
Étape 6

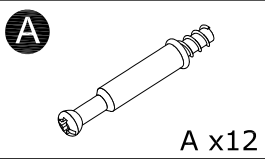
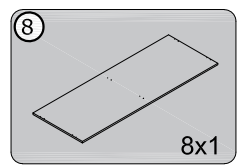
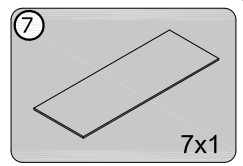
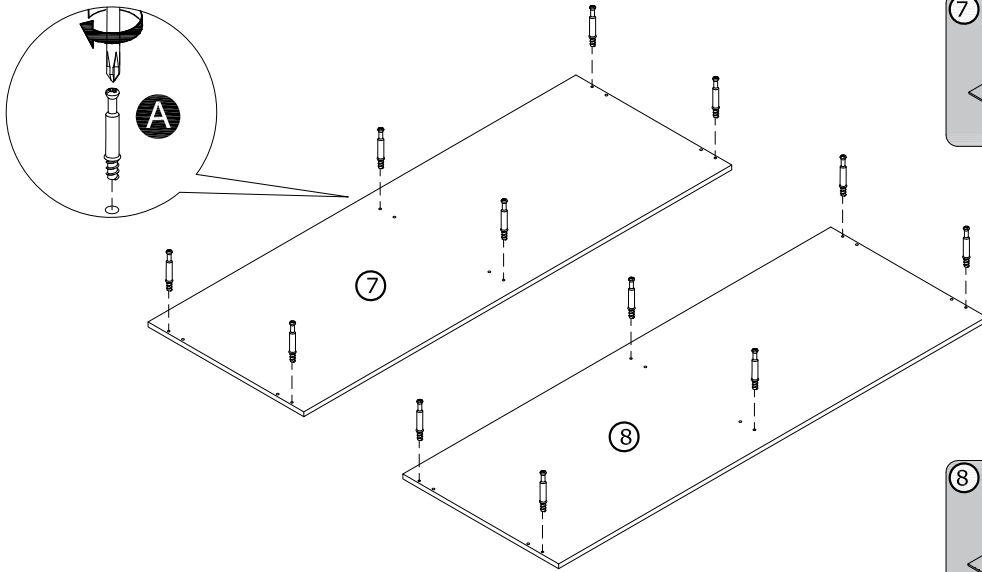

Step 7
Étape 7

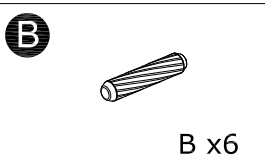
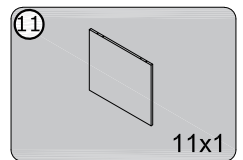
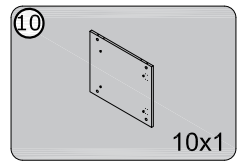
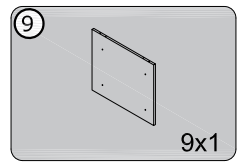
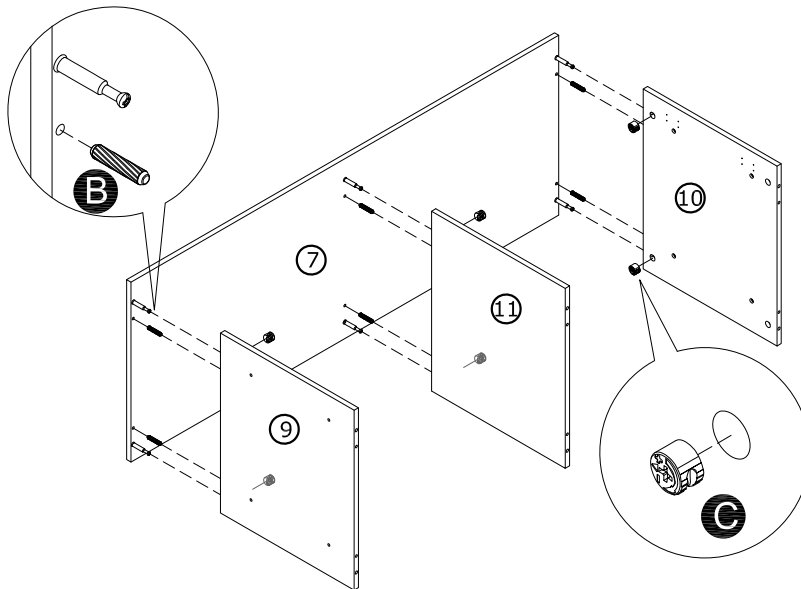

Step 8
Étape 8

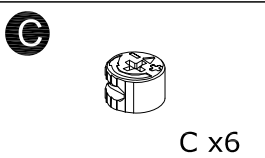
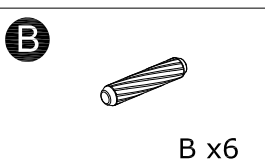
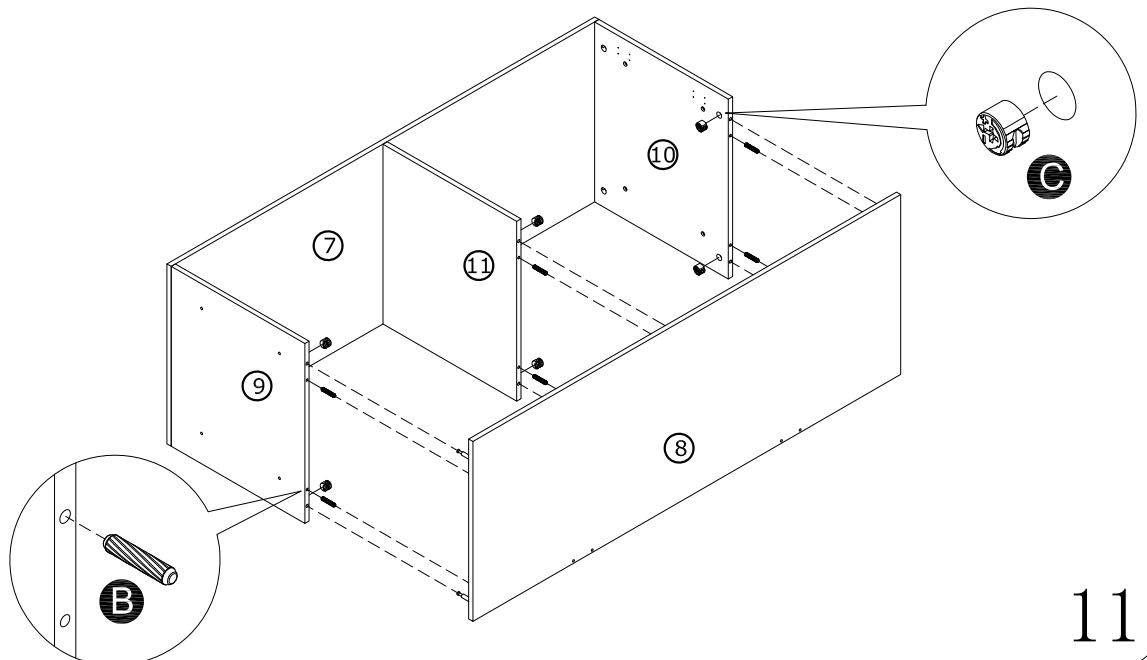

Assembly instructions / Instructions de montage

Step 9

Étape 9

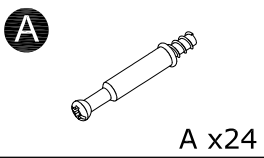
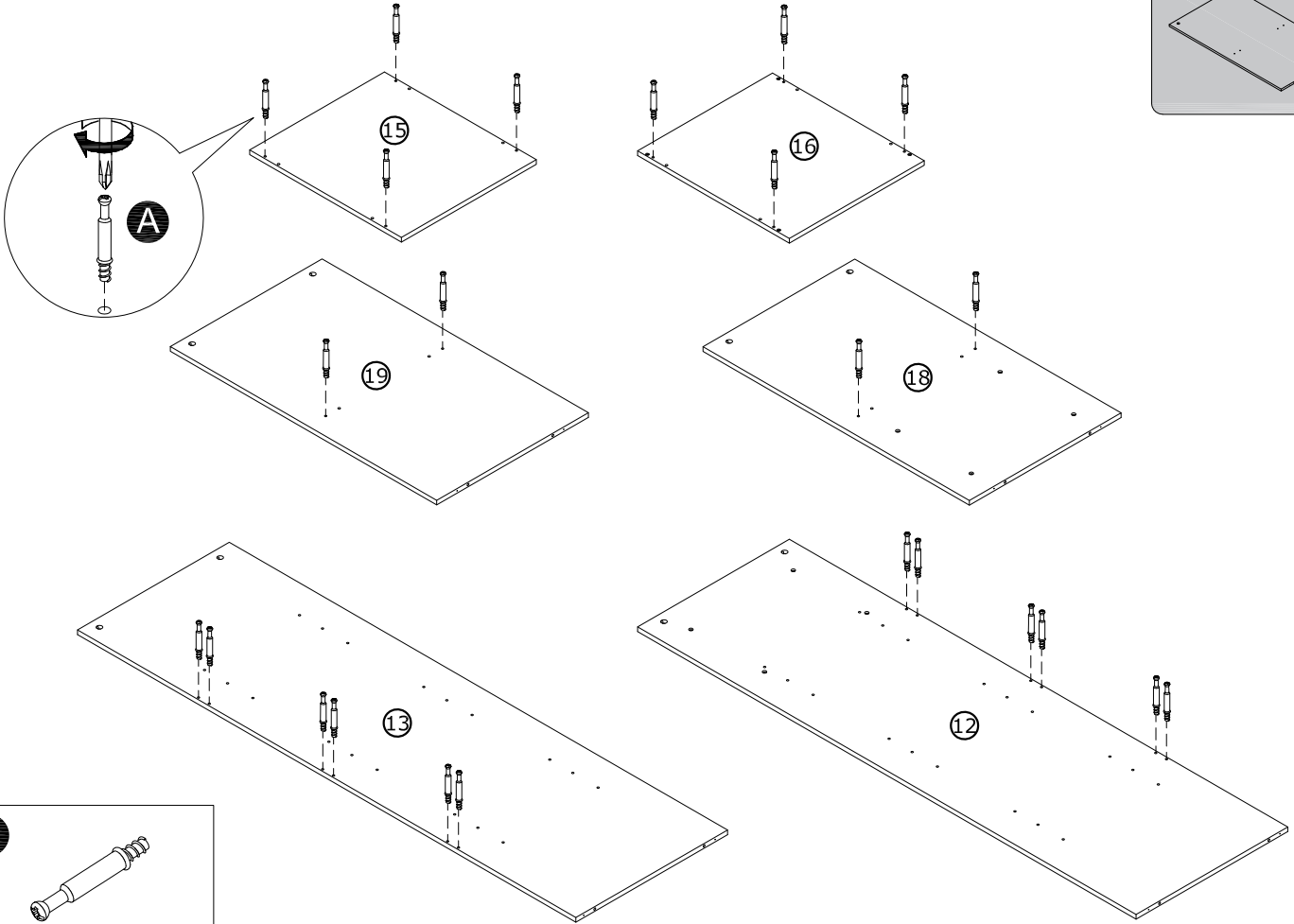
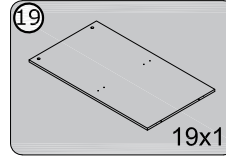
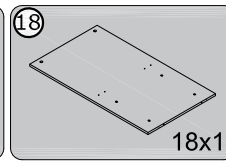
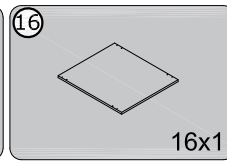
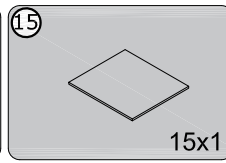
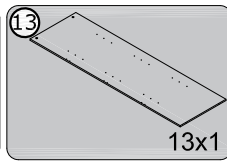
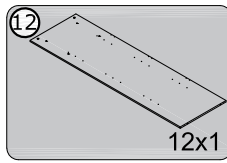

Step 10

Étape 10

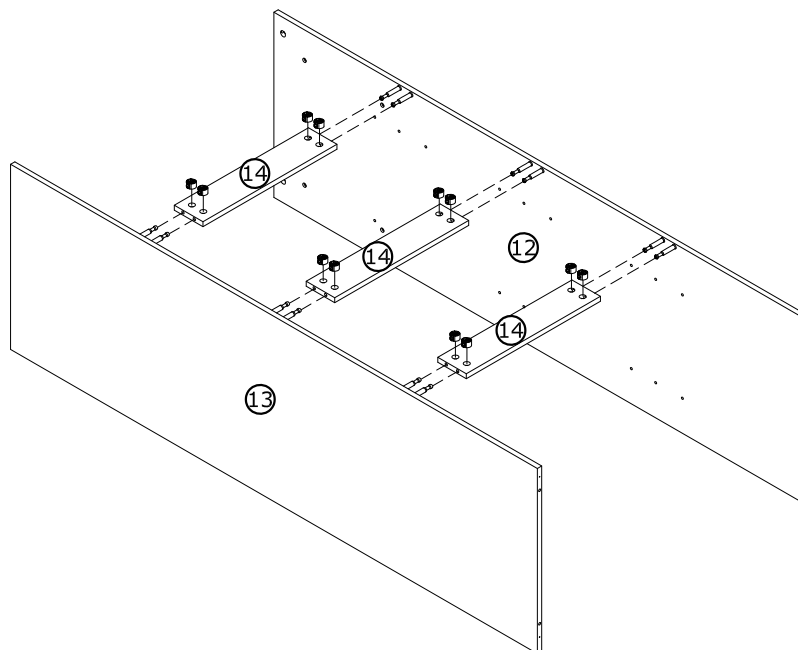
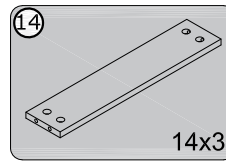

Assembly instructions / Instructions de montage

Step 11

Étape 11

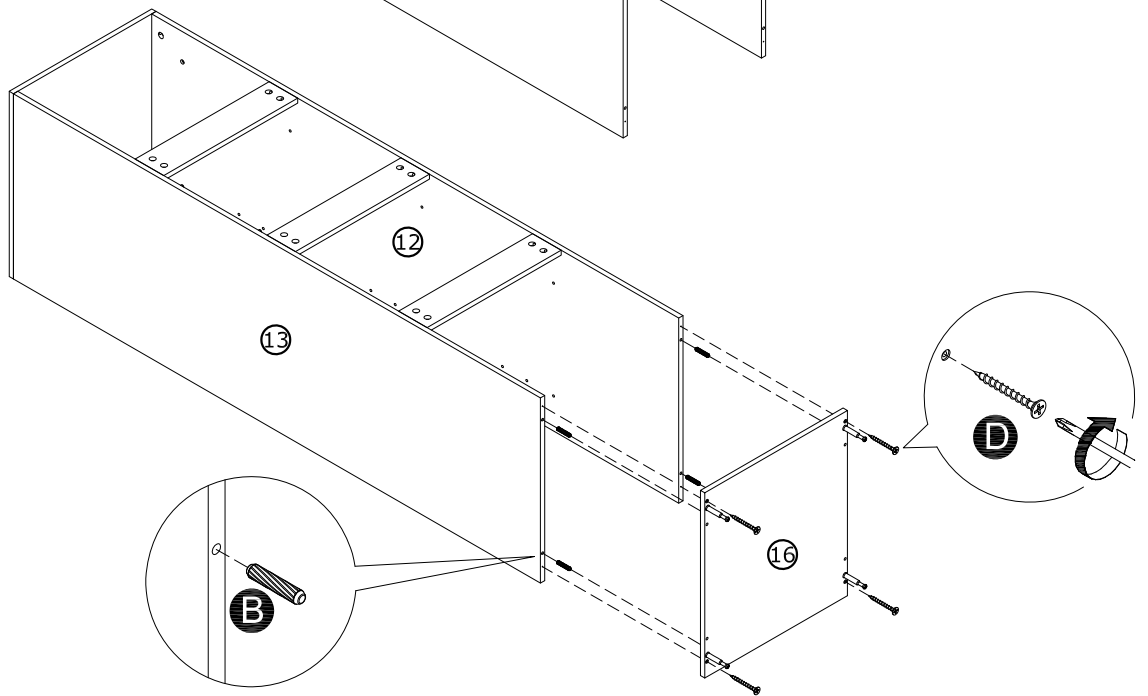
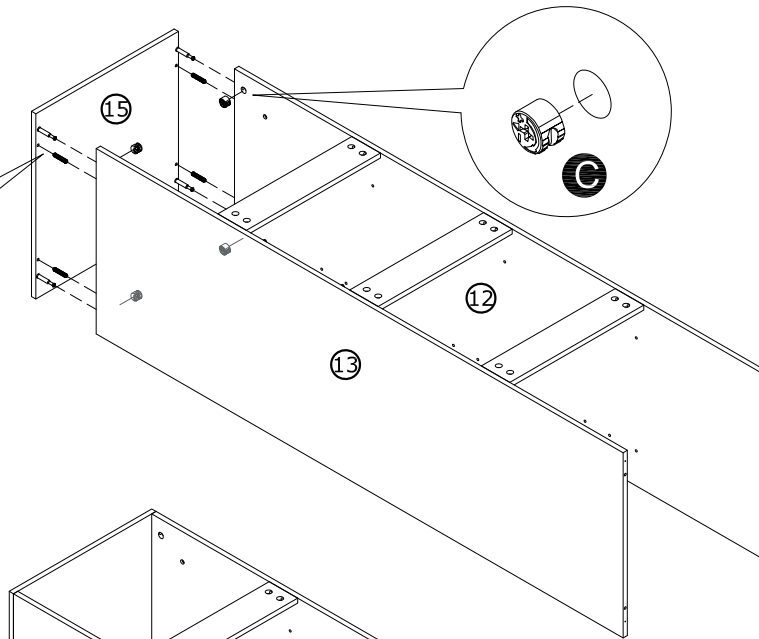
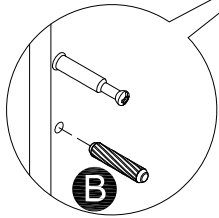

B



B x8

C



C x4

D



D x4

Step 12

Étape 12

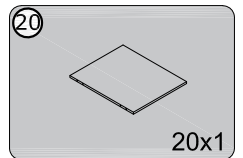
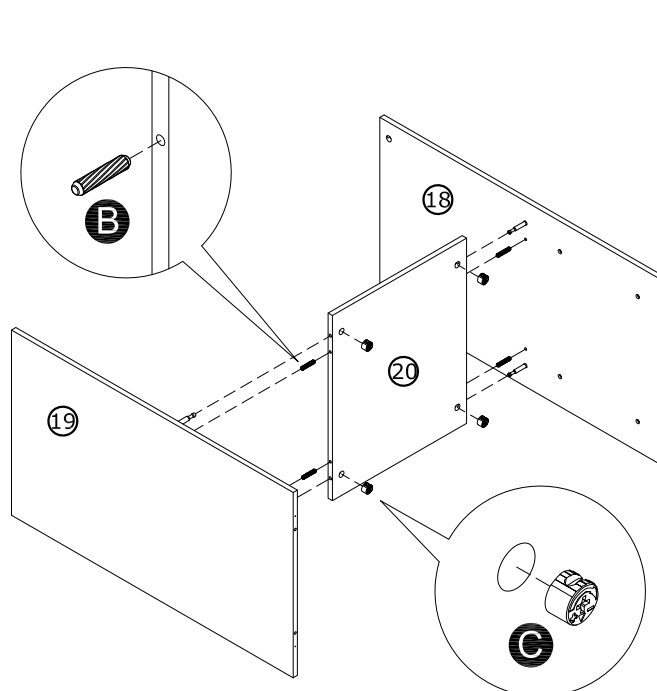
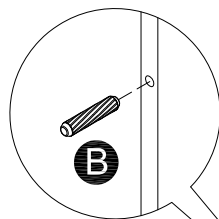

20x1

B



B x4

C



C x4

Assembly instructions / Instructions de montage

Step 13

Étape 13

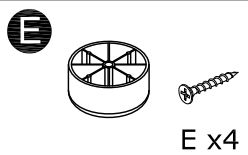
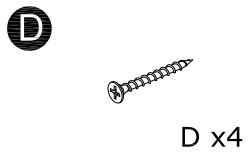
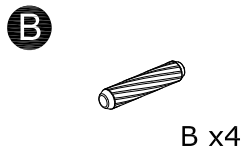
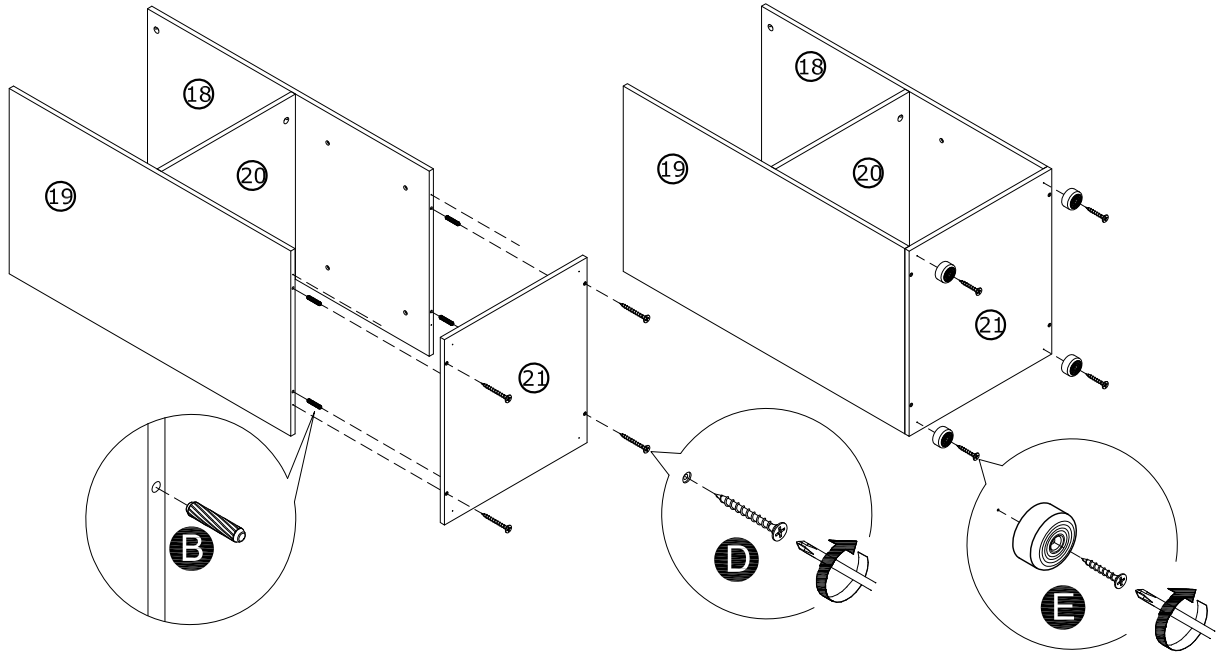
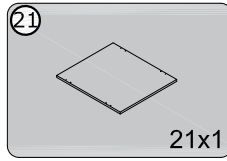

Step 14

Étape 14

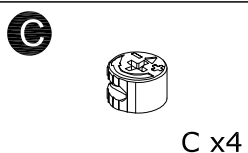
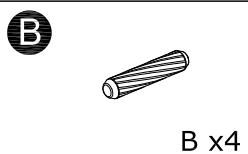
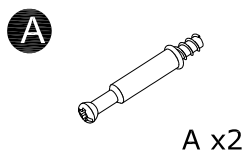
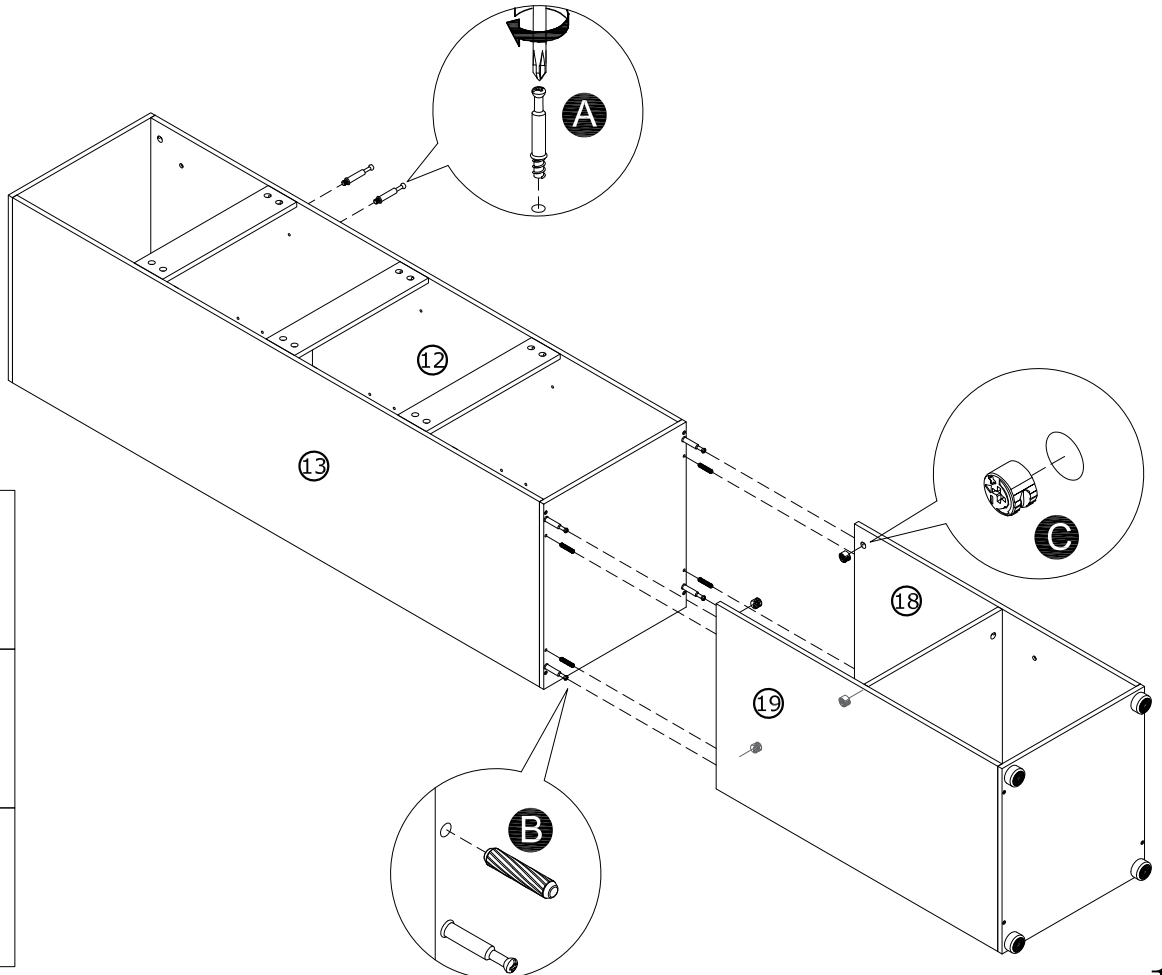

Assembly instructions / Instructions de montage

Step 15

Étape 15

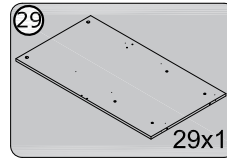
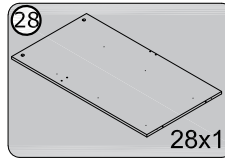

J



J x18

CL



CL x3

CR



CR x3

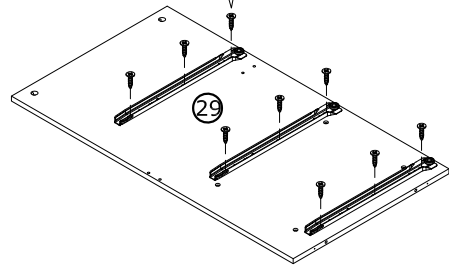
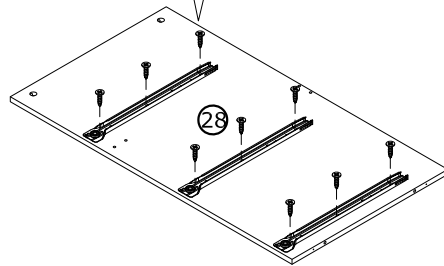
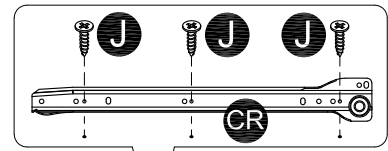
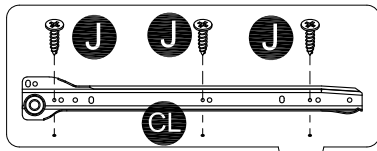

Step 16

Étape 16

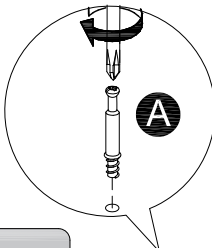
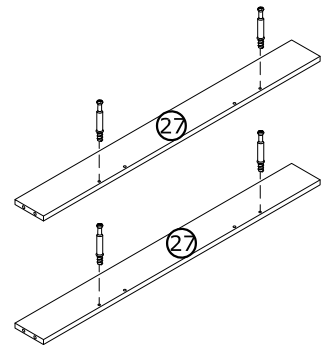
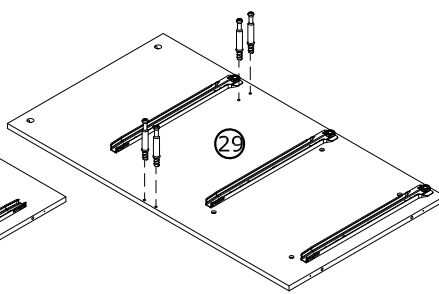
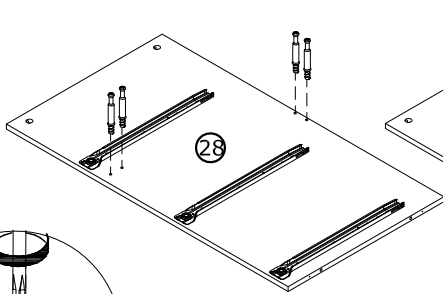

24

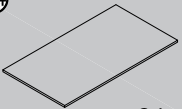

24x1

23

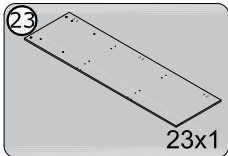

23x1

A

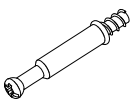

A x36

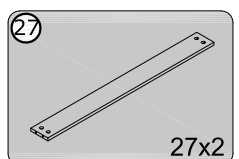
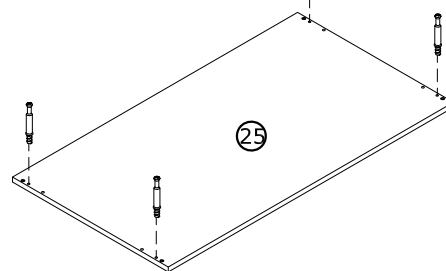
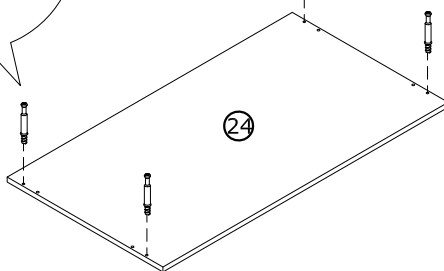

27x2

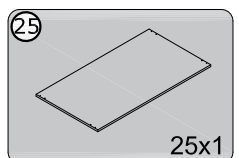

25x1

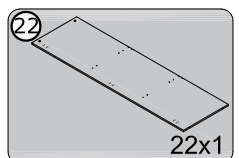

22x1

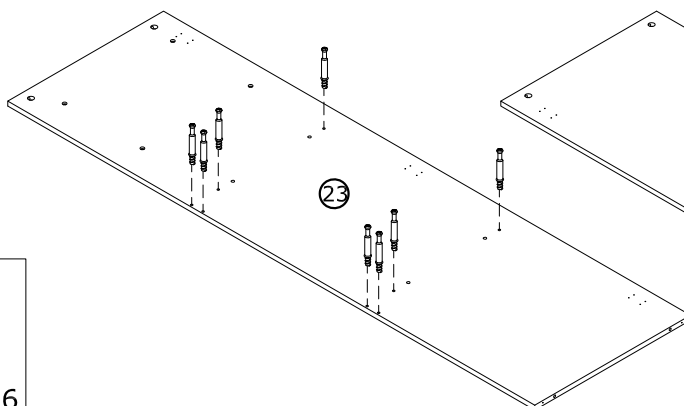

22

Assembly instructions / Instructions de montage

Step 17

Étape 17

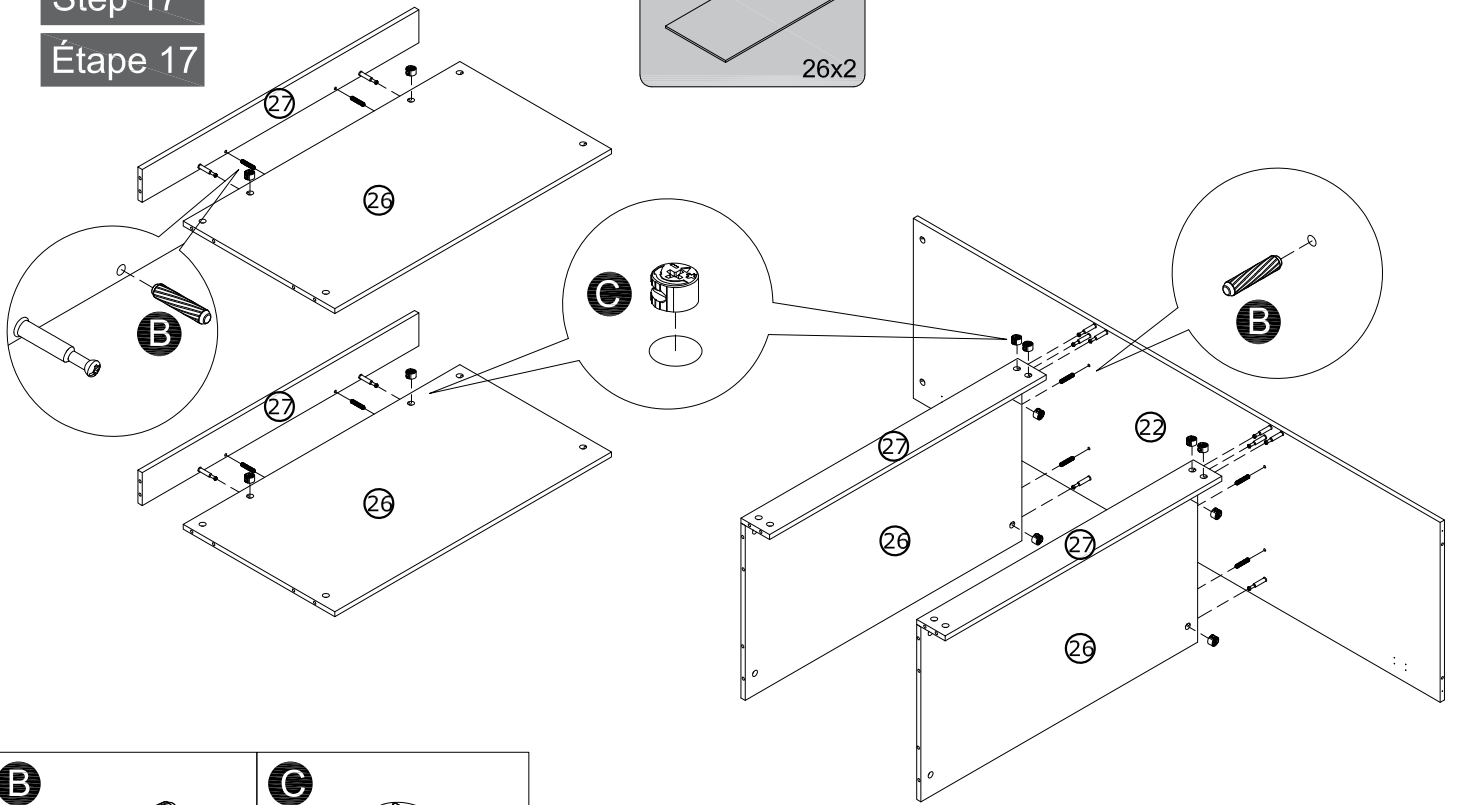
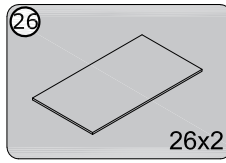

B



B x8

C



C x12

Step 18

Étape 18

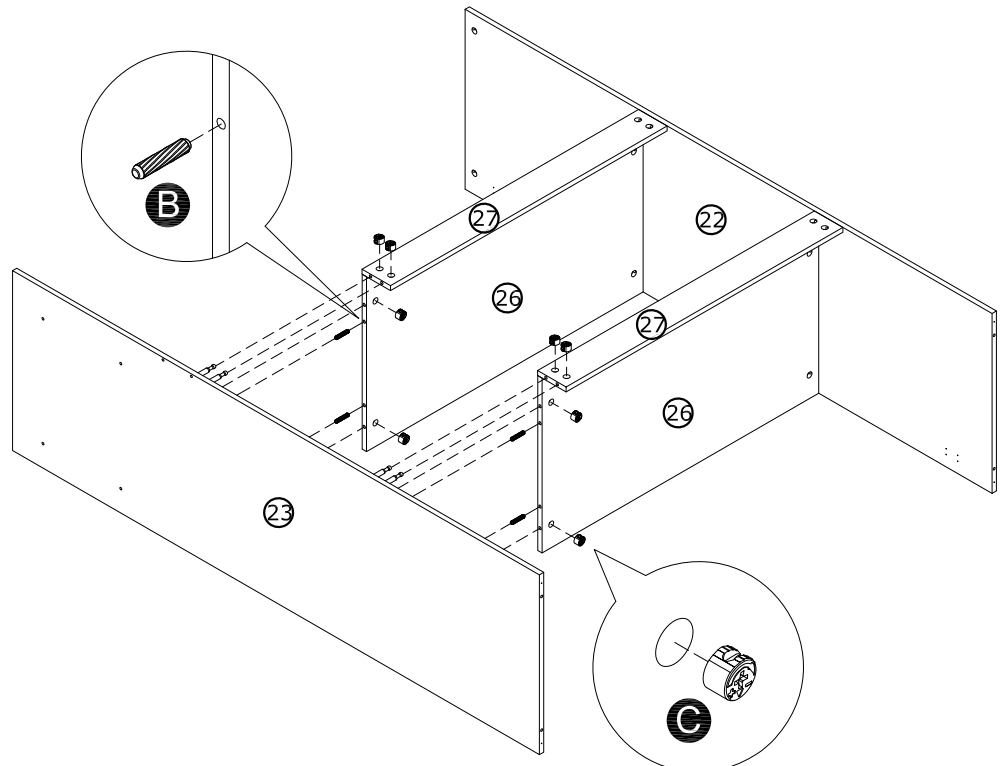

B



B x4

C



C x8

Assembly instructions / Instructions de montage

Step 19

Étape 19

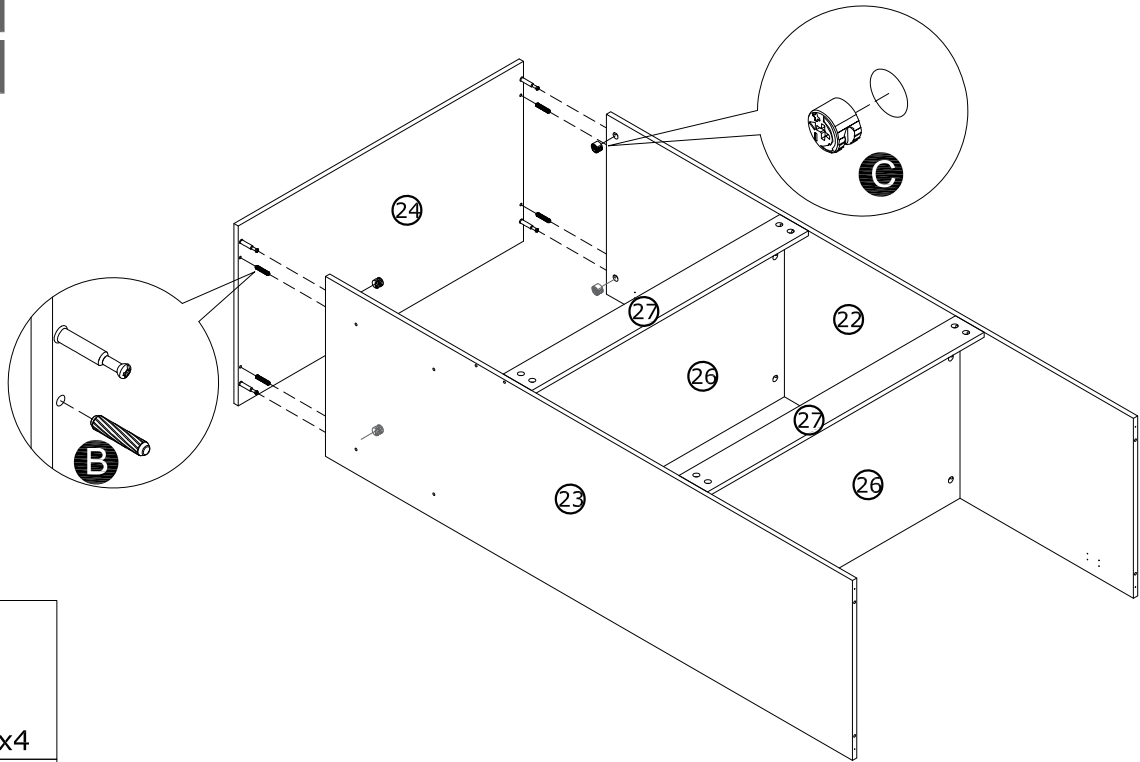

B



B x4

C



C x4

Step 20

Étape 20

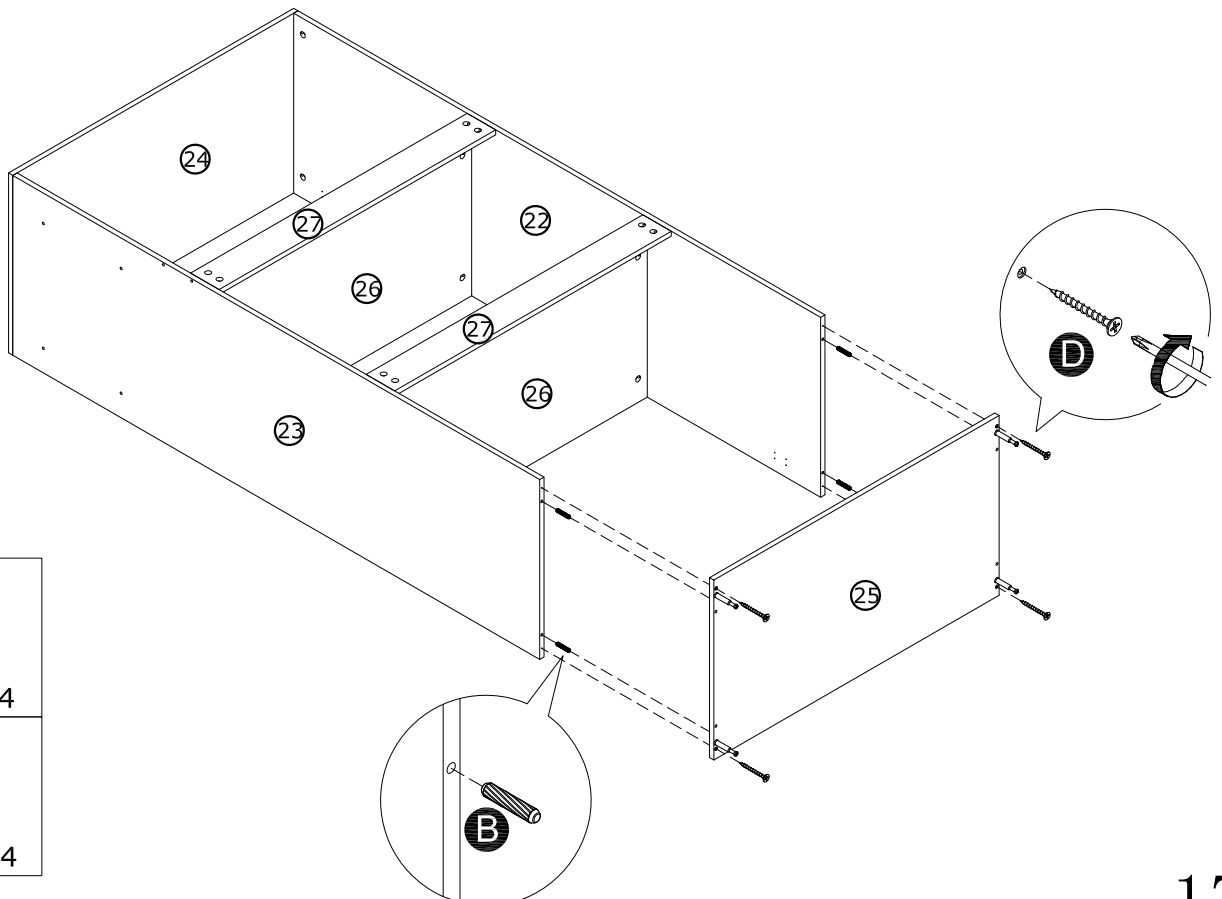

B



B x4

D



D x4

Assembly instructions / Instructions de montage

Step 21

Étape 21

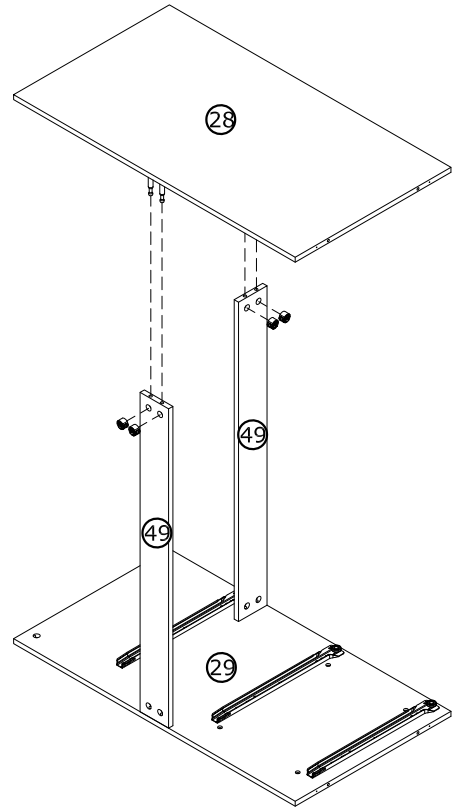
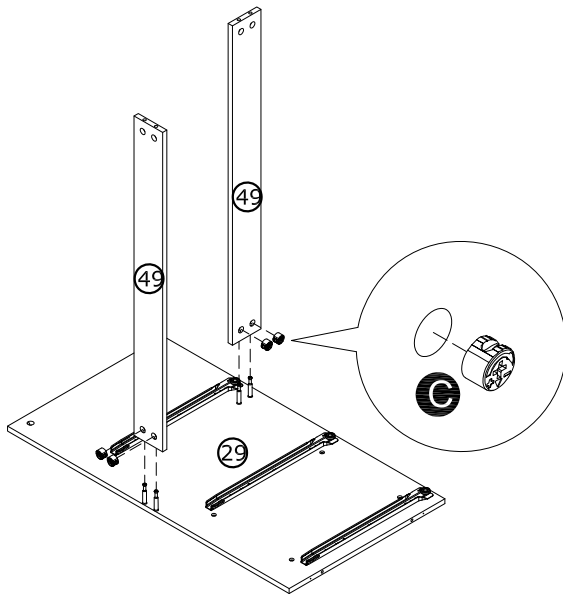
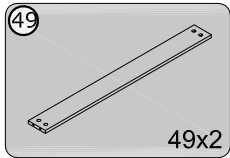

Step 22

Étape 22

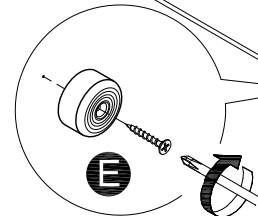
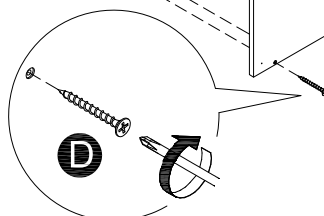
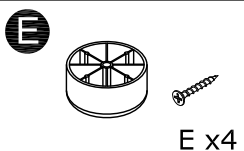
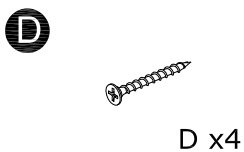
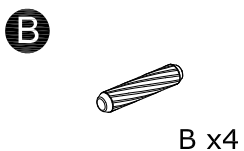
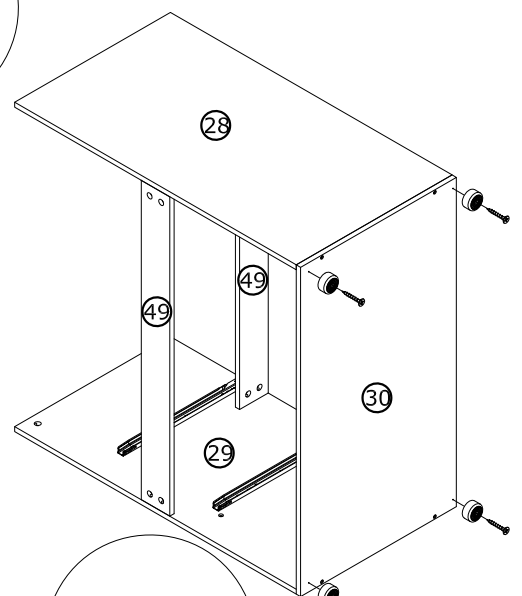
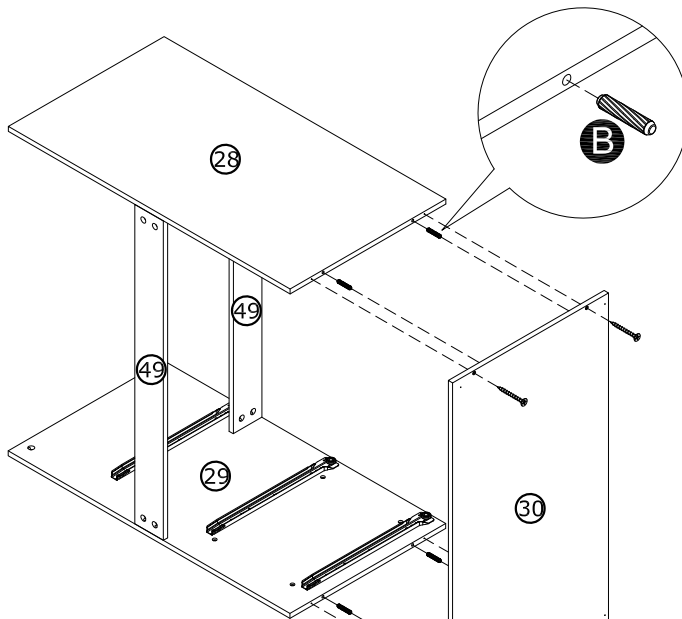
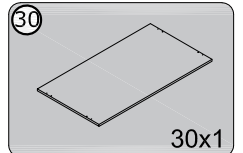

Assembly instructions / Instructions de montage

Step 23

Étape 23

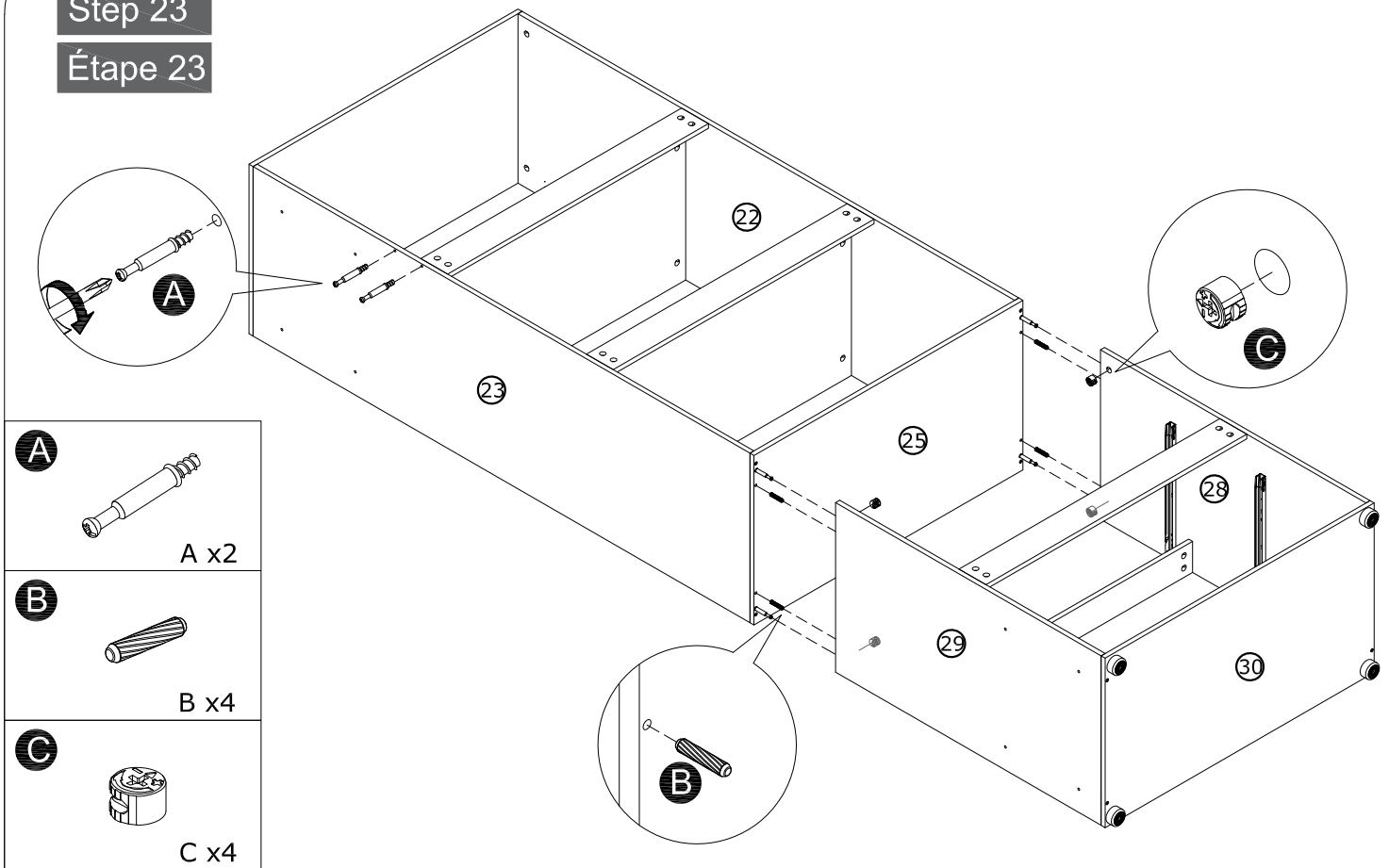

Step 24

Étape 24

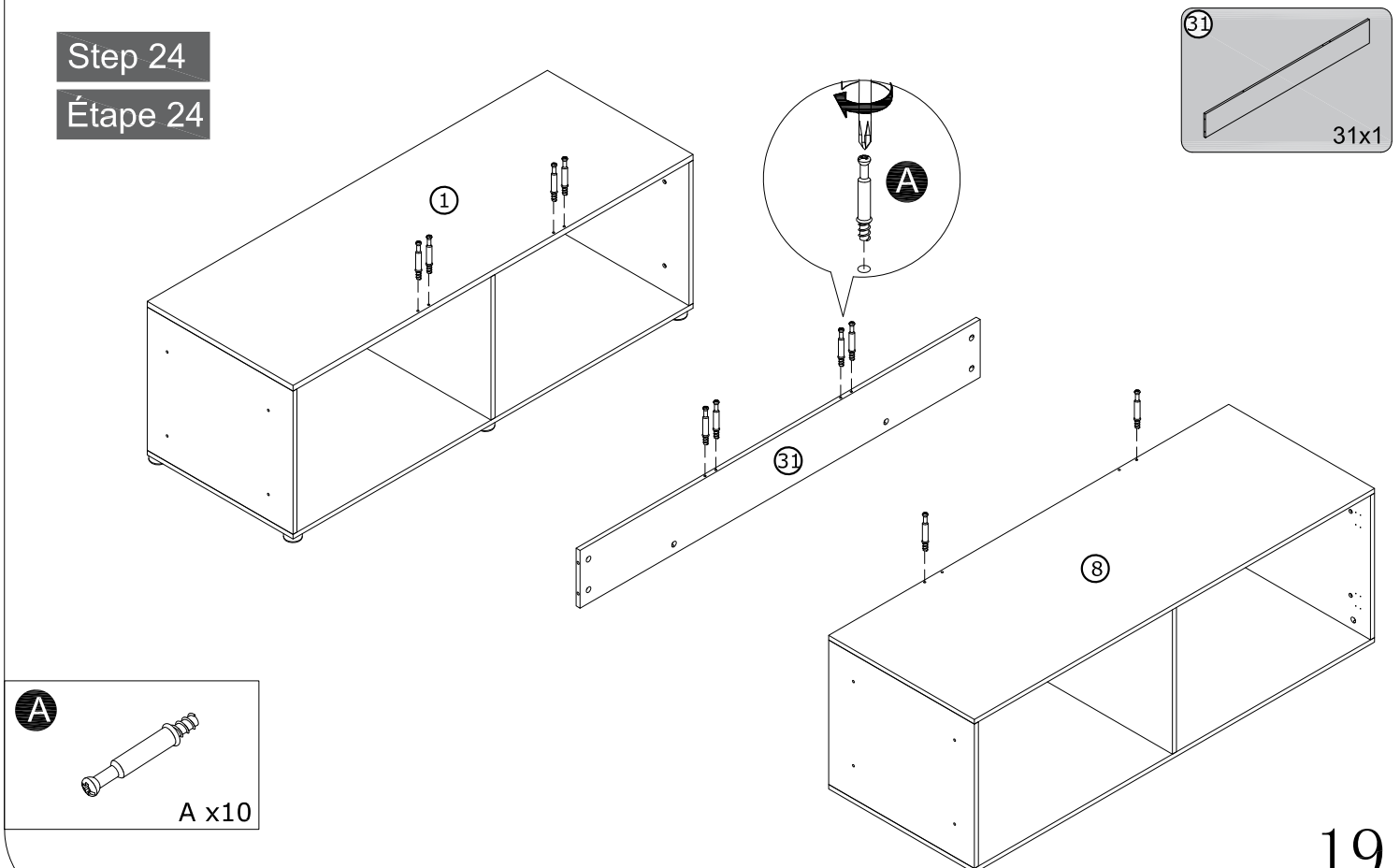

Assembly instructions / Instructions de montage

Step 25

Étape 25

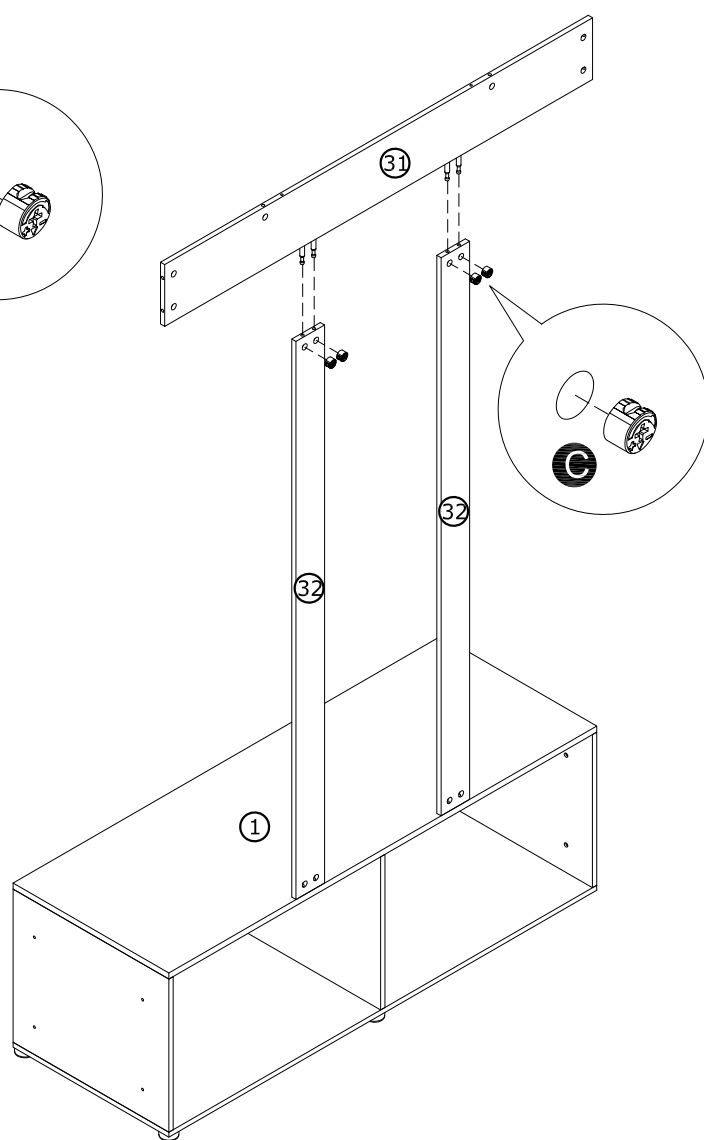
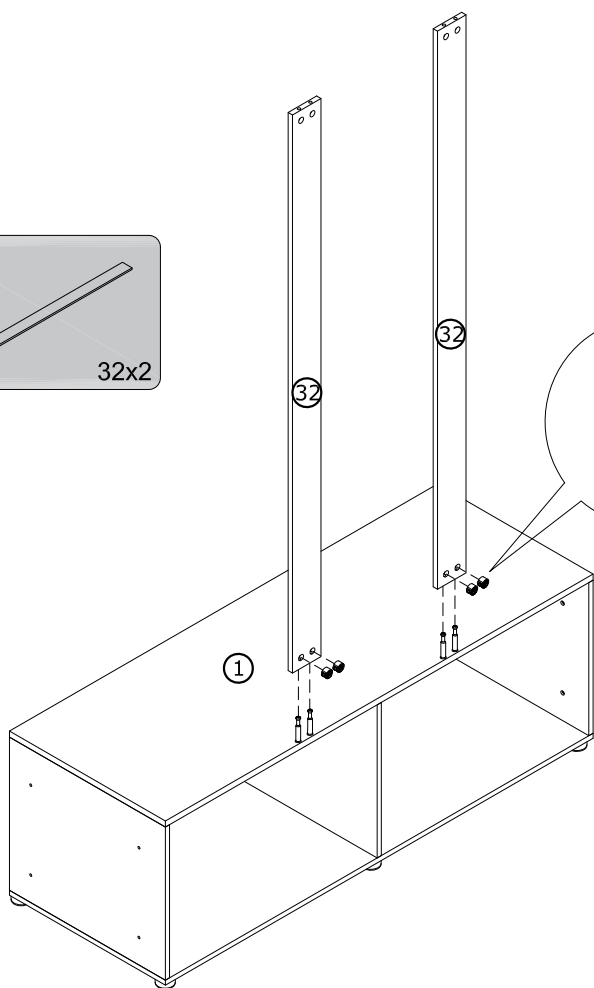
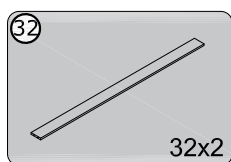

C x8

Assembly instructions / Instructions de montage

Step 26

Étape 26

C



C x4

F

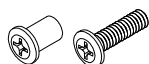

F x8

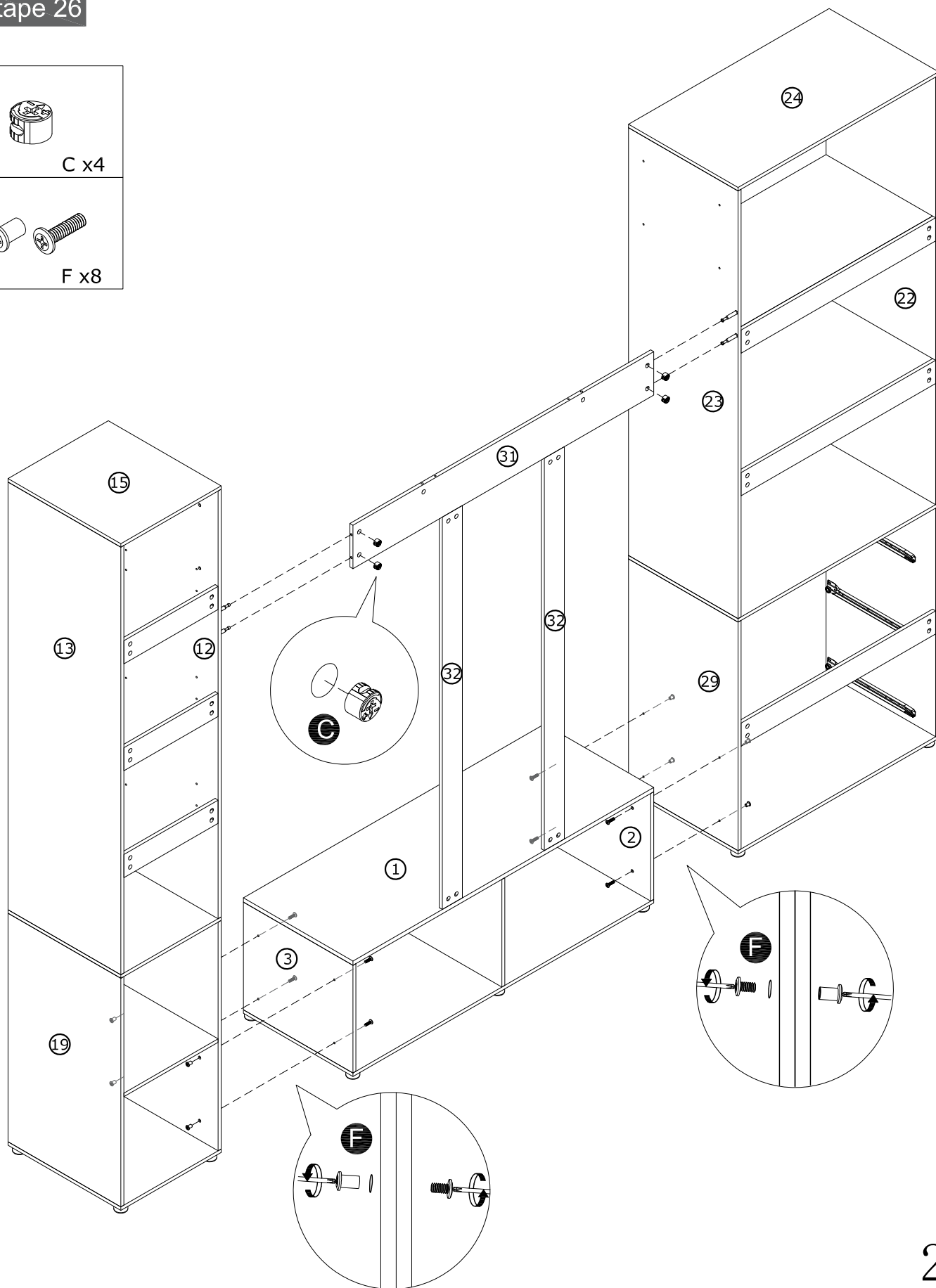

Assembly instructions / Instructions de montage

Step 27

Étape 27

B



B x2

C



C x2

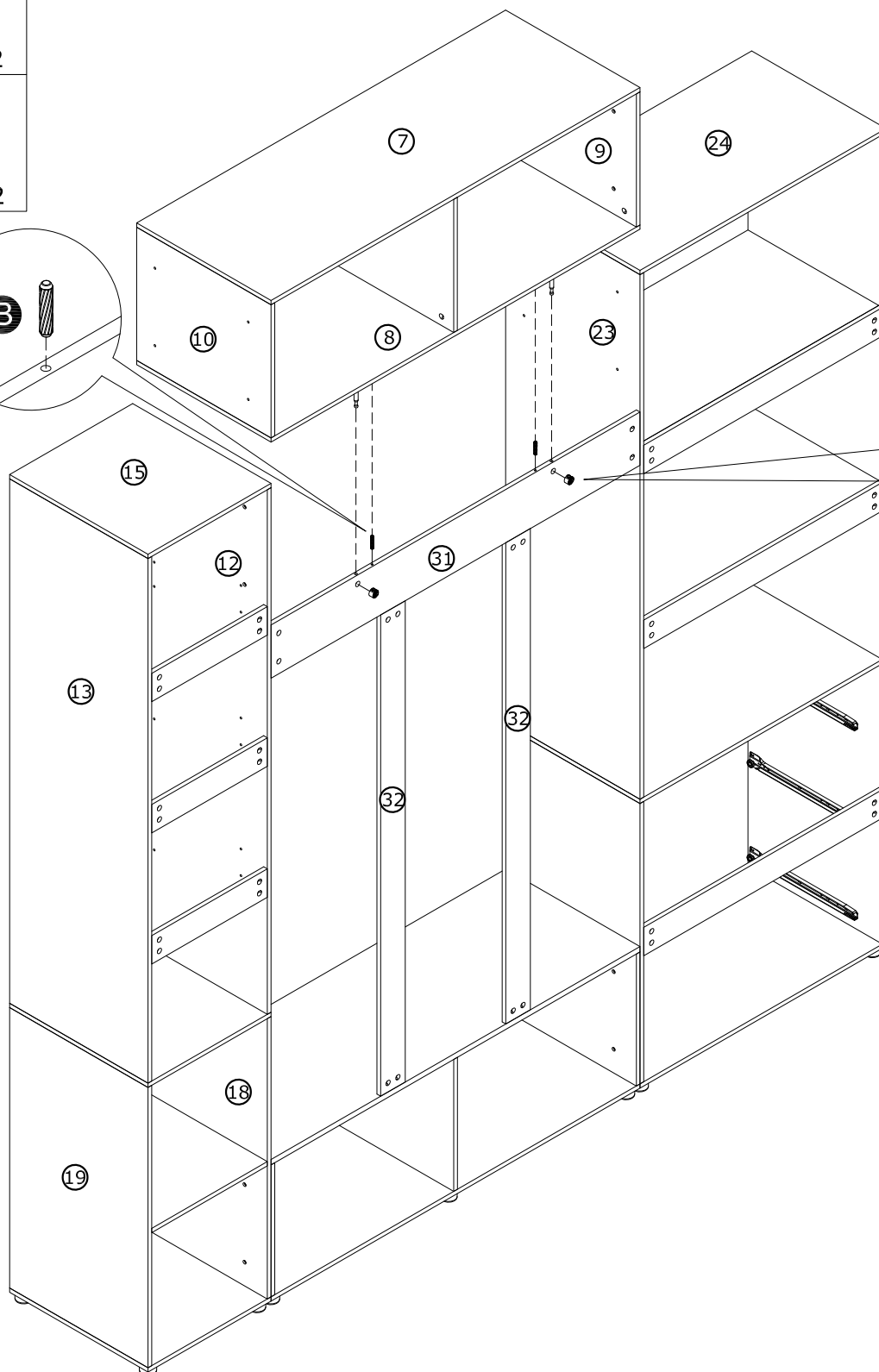
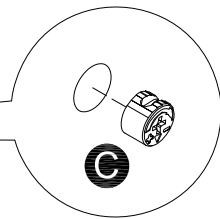
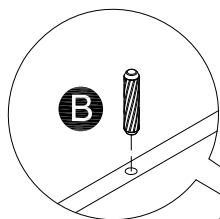

Assembly instructions / Instructions de montage

Step 28

Étape 28

F

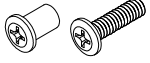

F x8

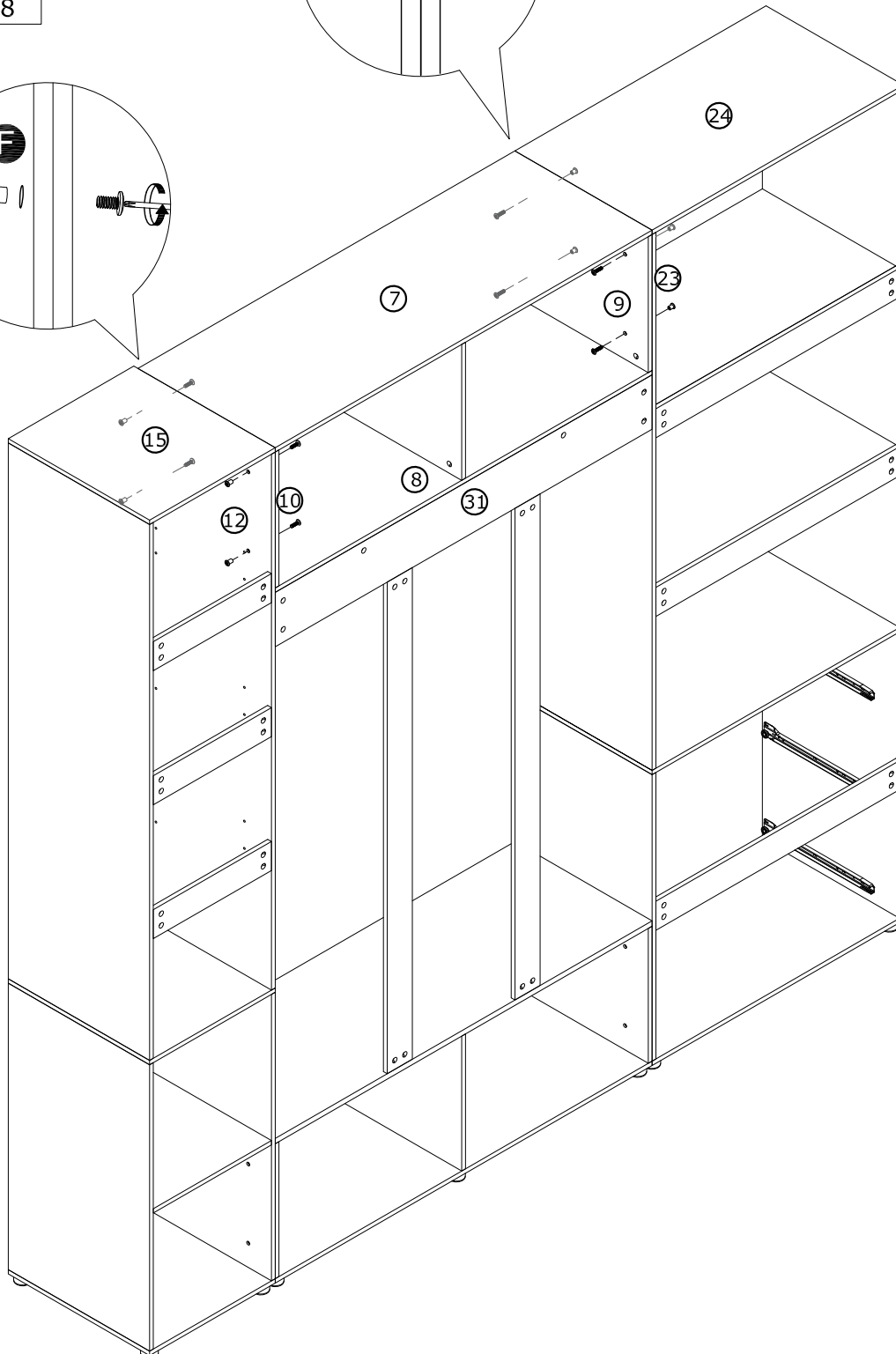
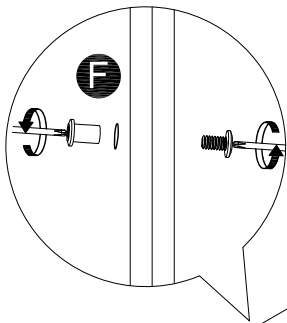
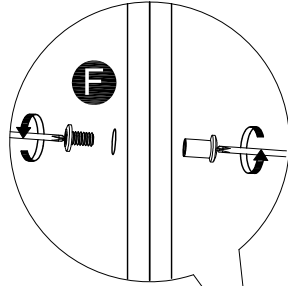

Assembly instructions / Instructions de montage

Step 29

Étape 29

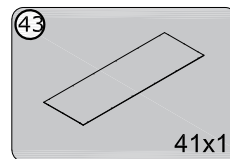

G



G x12

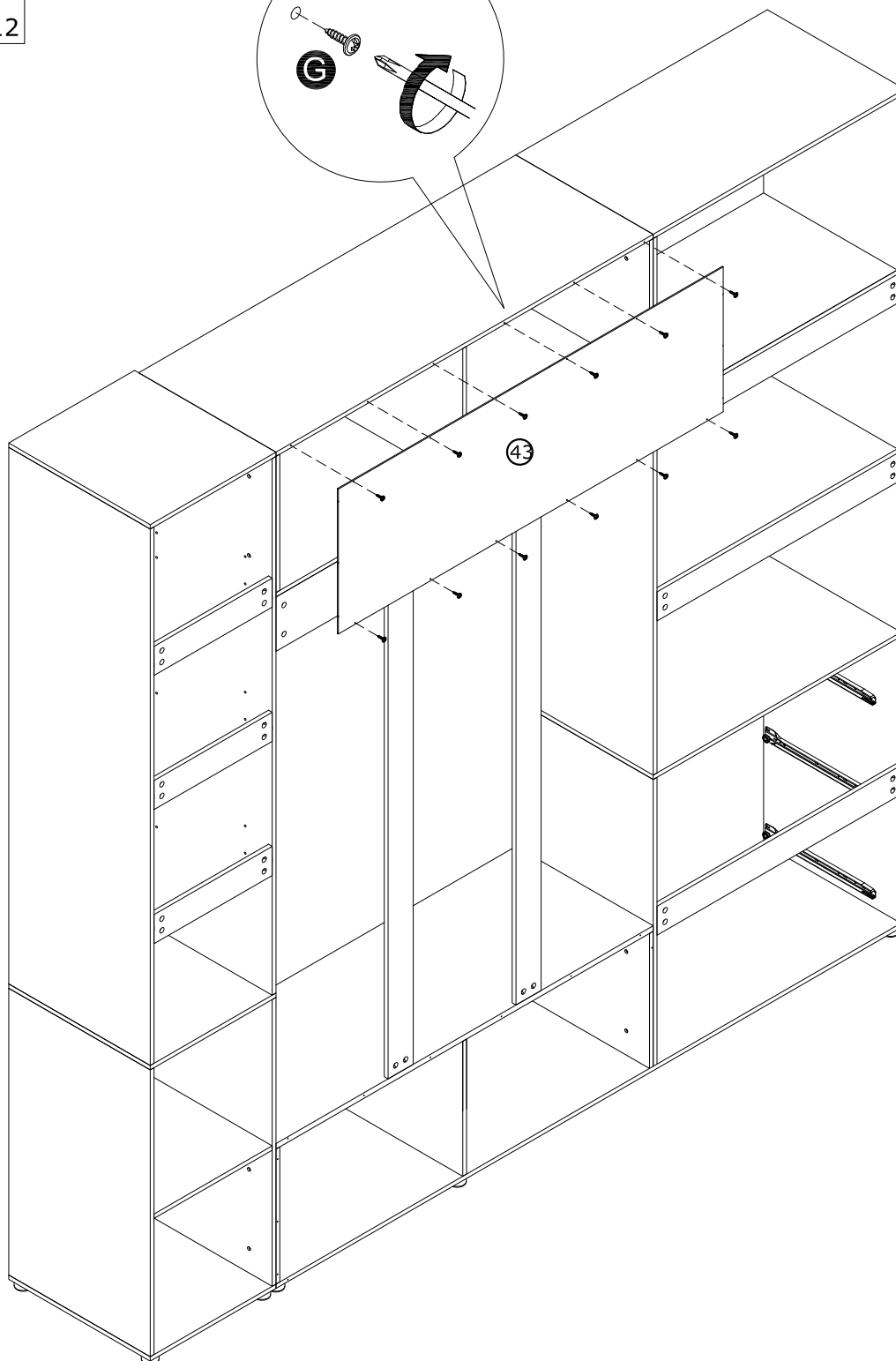
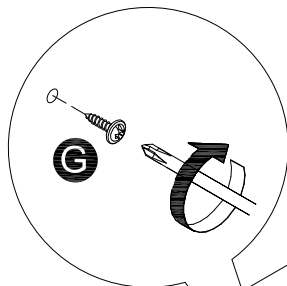

Assembly instructions / Instructions de montage

Step 30

Étape 30

G



G x109

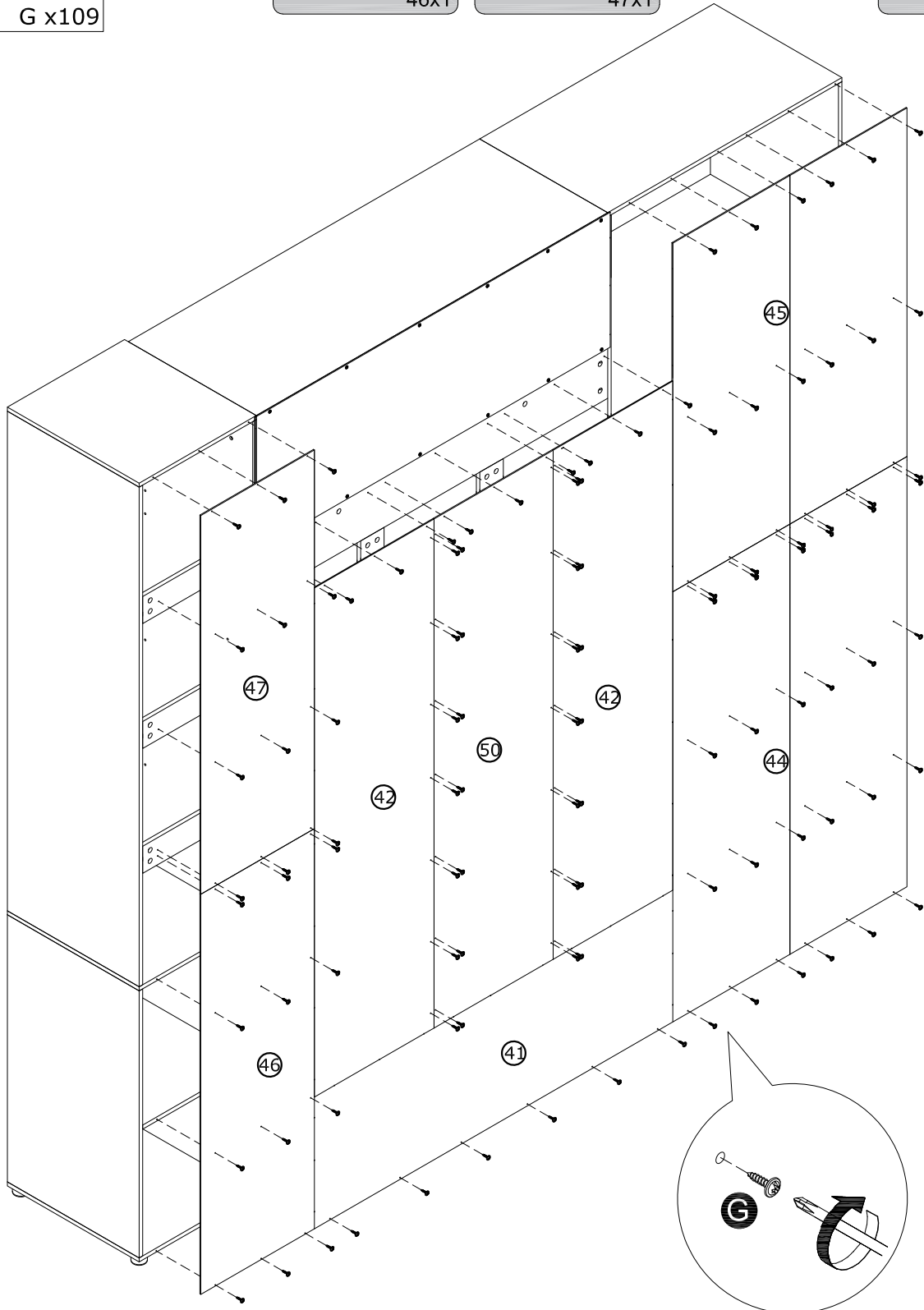
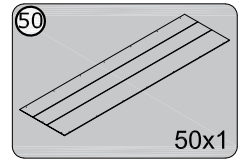
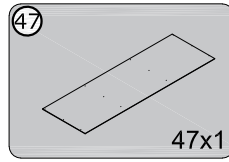
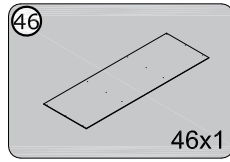
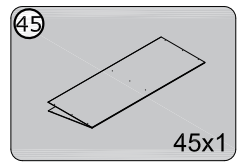
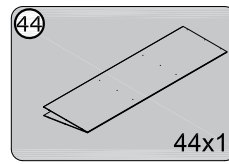
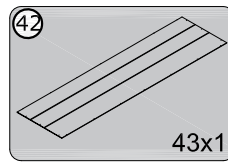
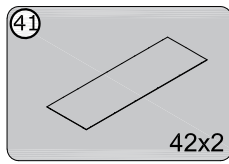

Assembly instructions / Instructions de montage

Step 31

Étape 31

G



G x35

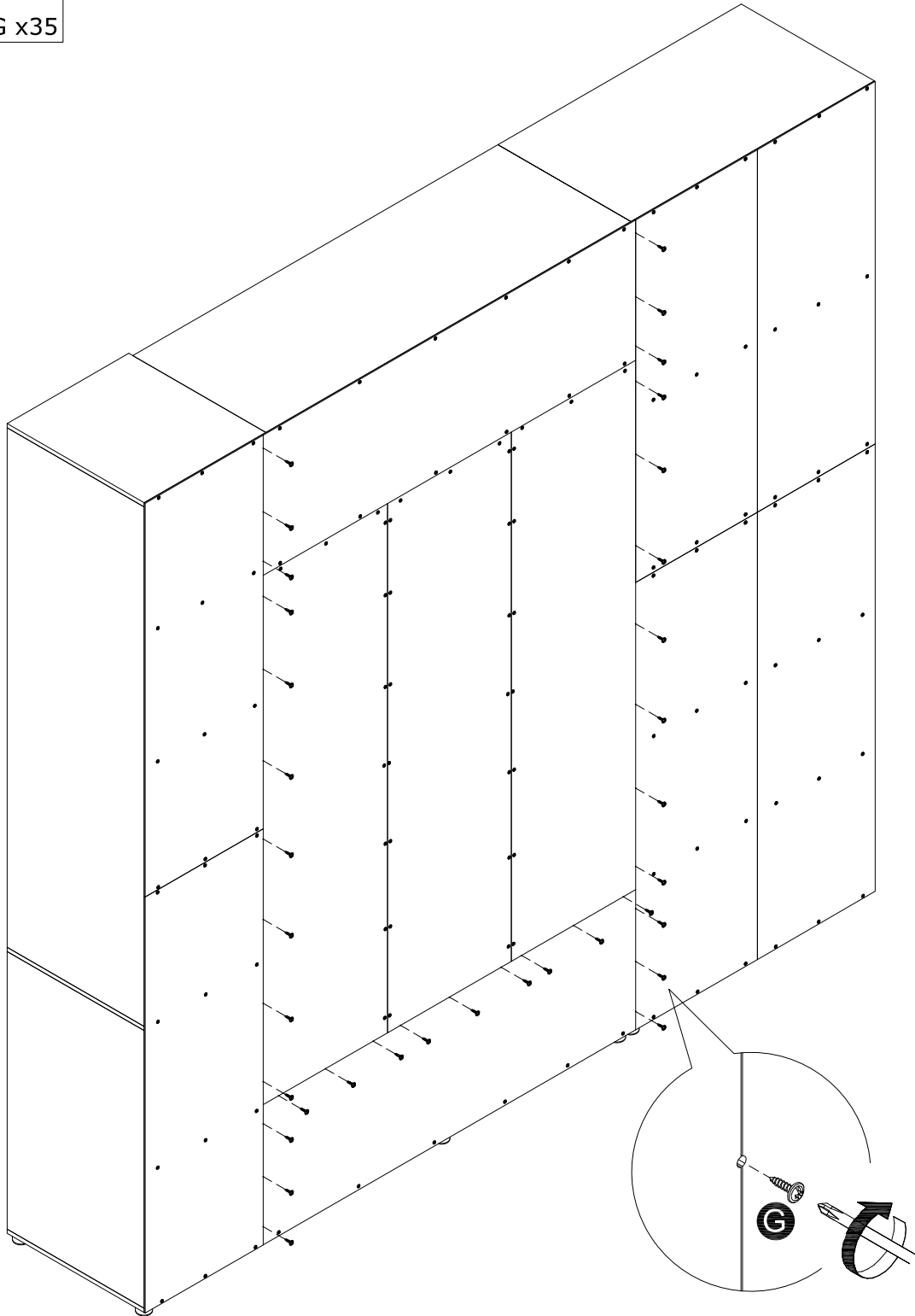

Assembly instructions / Instructions de montage

Step 32

Étape 32

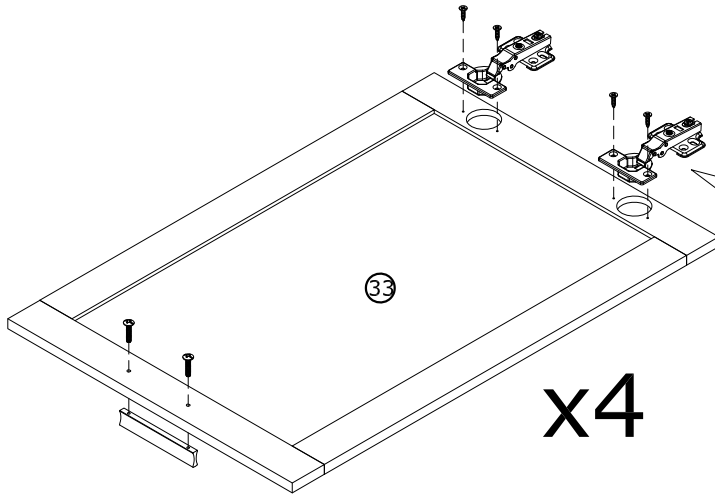
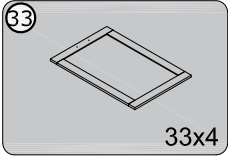

x4

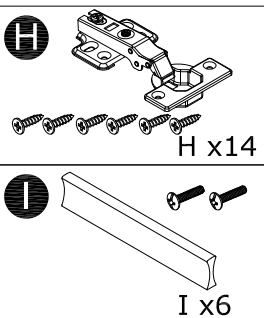
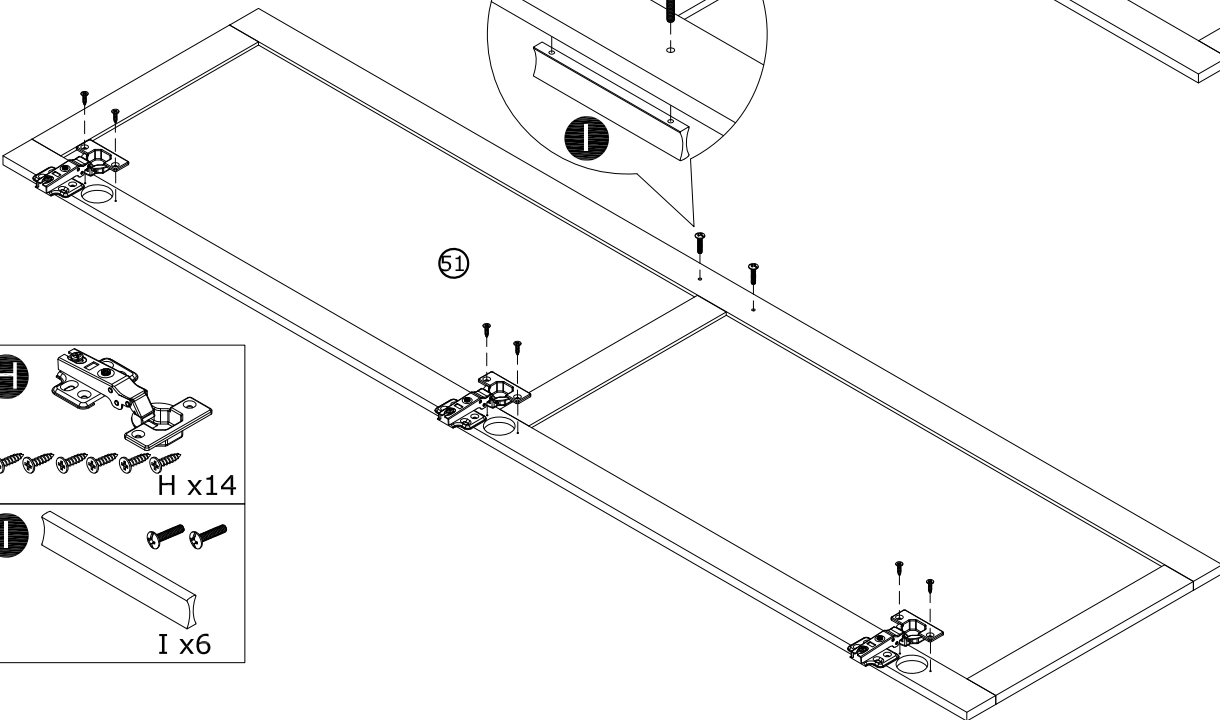
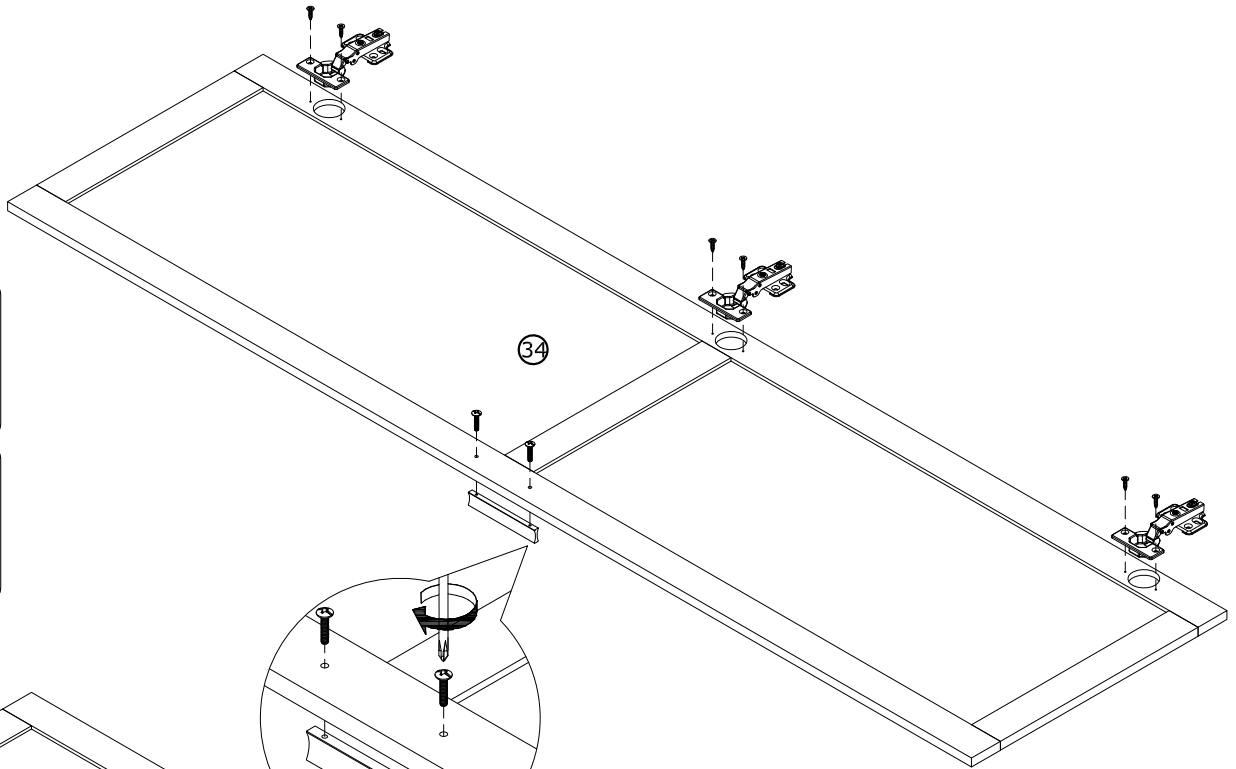
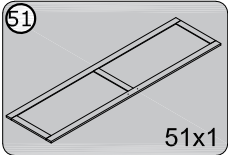
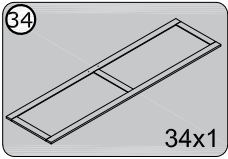

Assembly instructions / Instructions de montage

Step 33

Étape 33

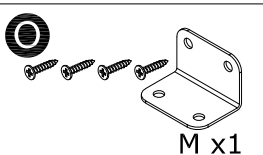
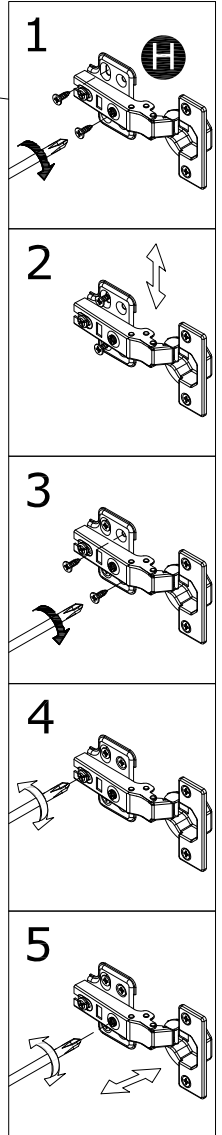
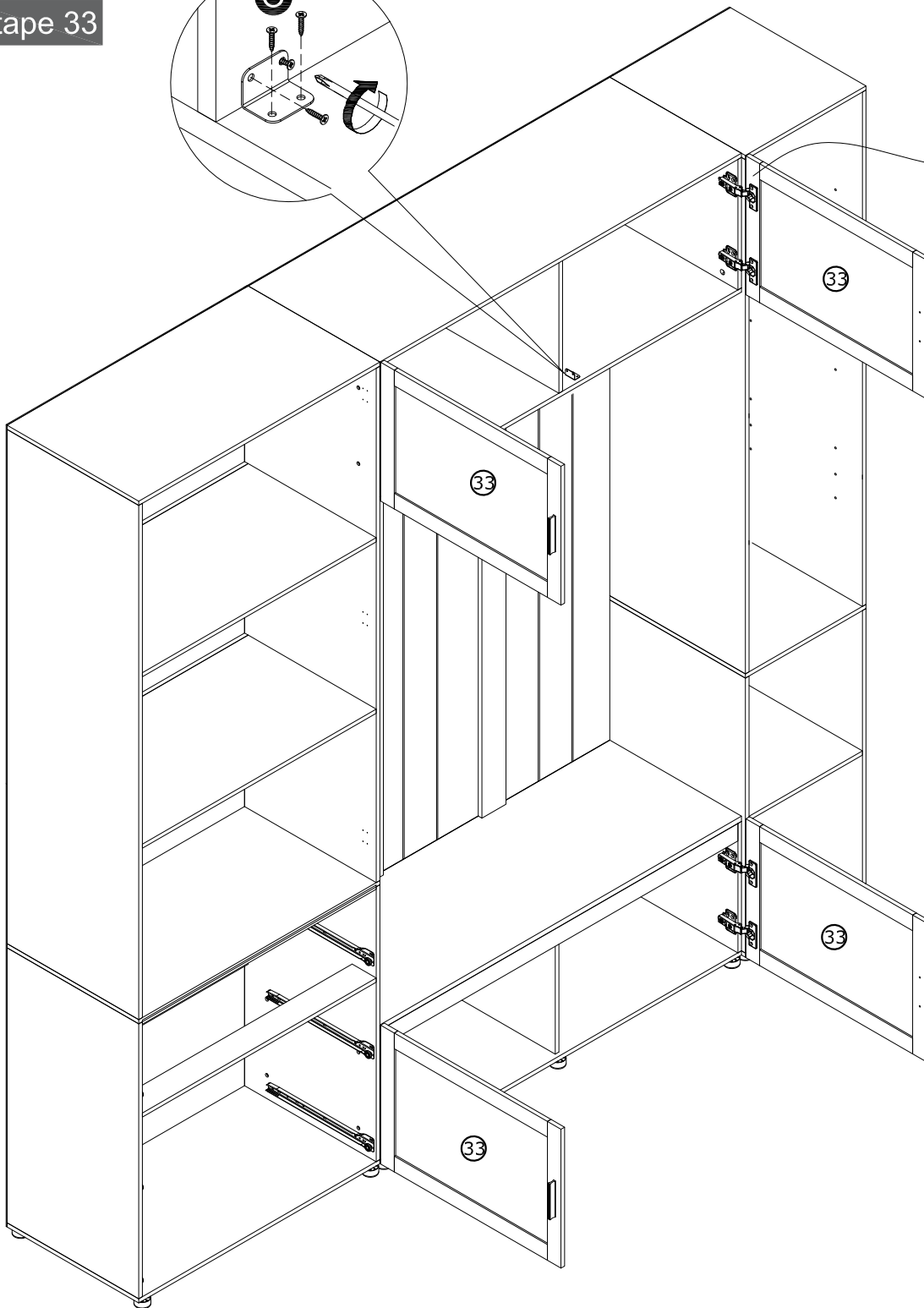
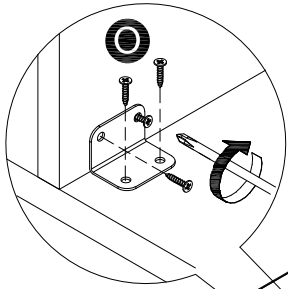

Assembly instructions / Instructions de montage

Step 34

Étape 34

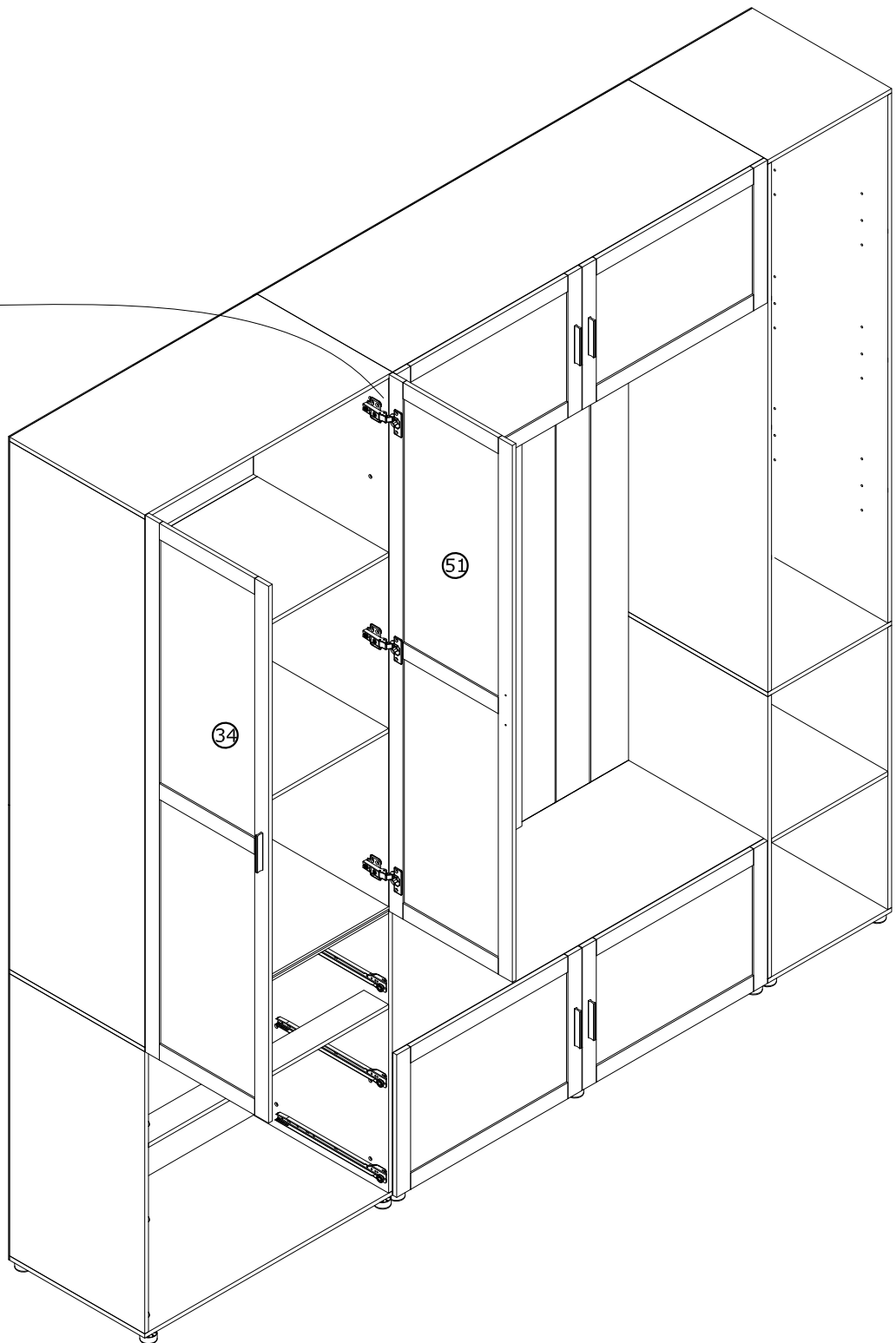
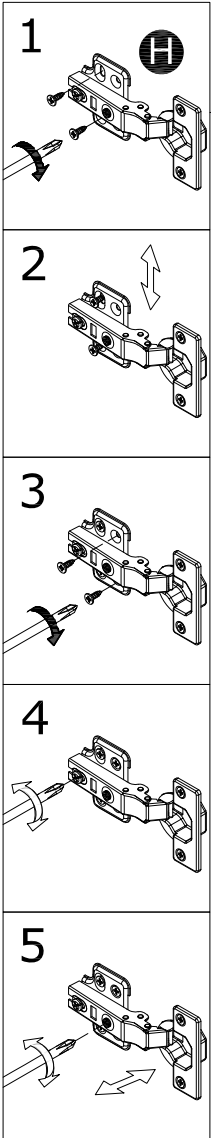

Assembly instructions / Instructions de montage

Step 35
Étape 35

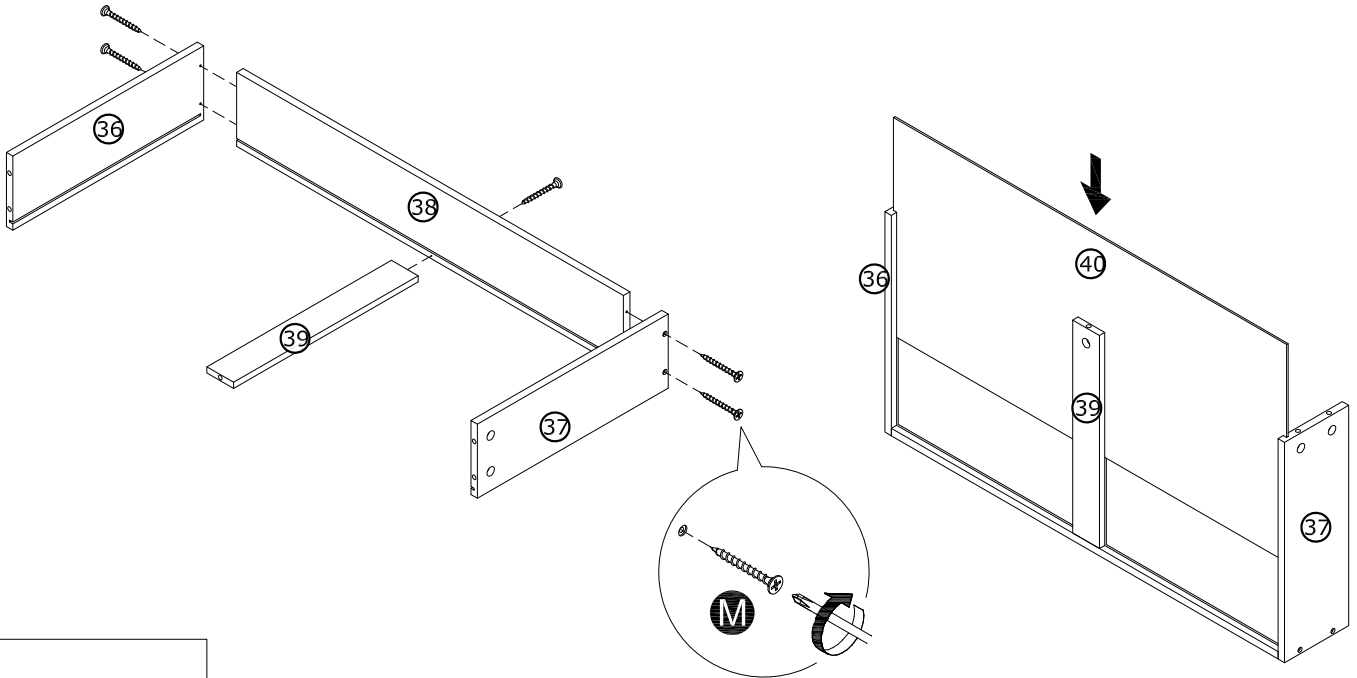
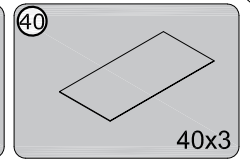
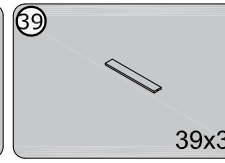
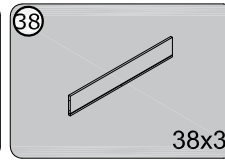
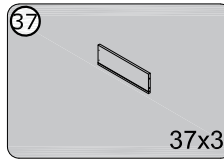
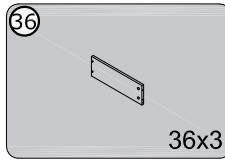

M



M x15

x3

Step 36
Étape 36

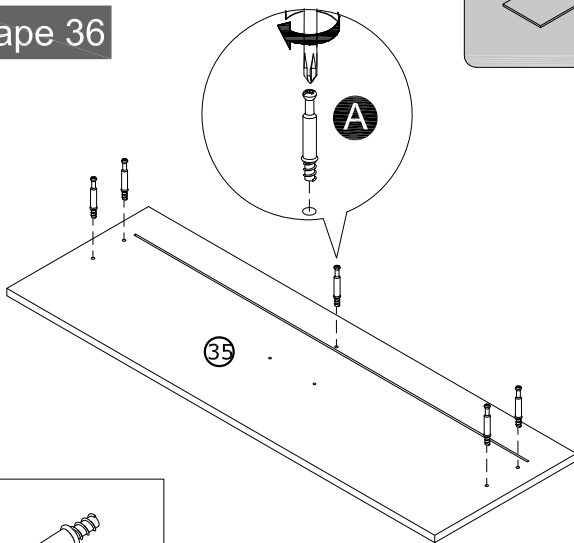
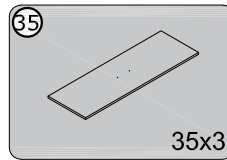

A

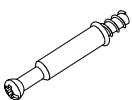

A x15

C



C x15

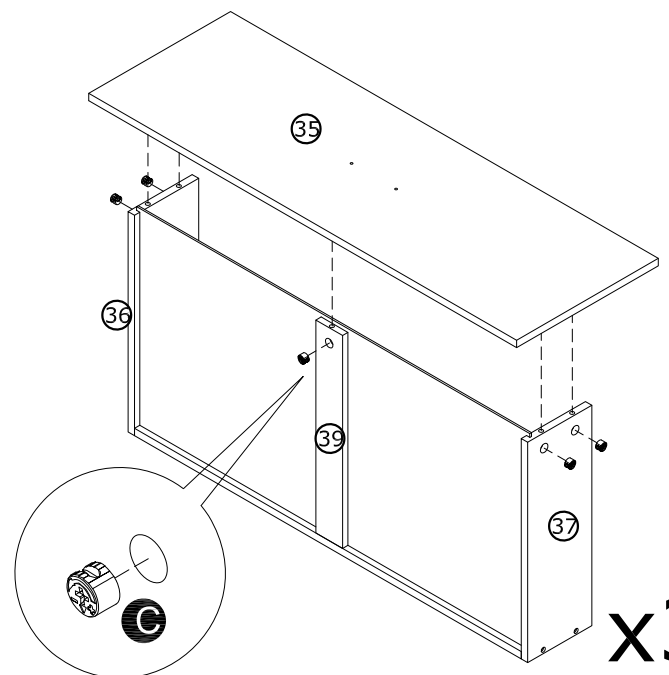

x3

30

Assembly instructions / Instructions de montage

Step 37

Étape 37

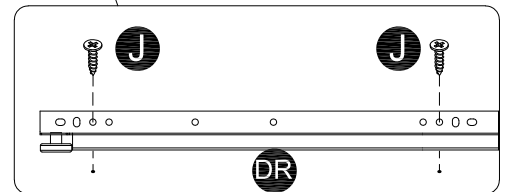
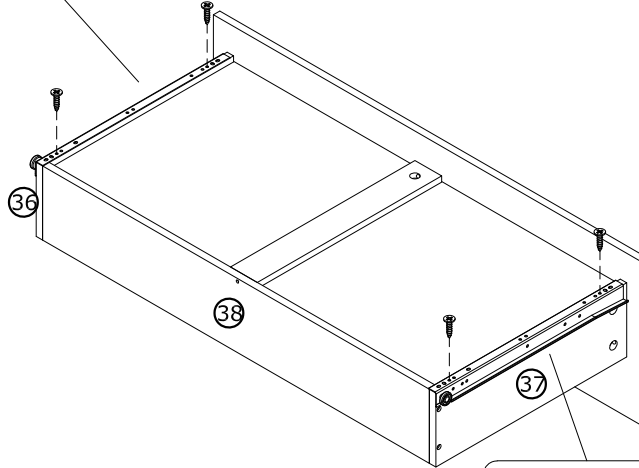
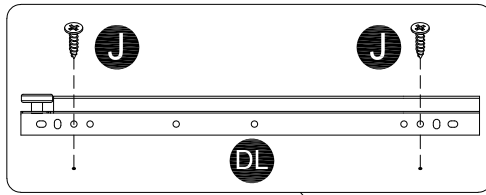

x3

J



J x12

DL

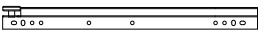

DL x3

DR

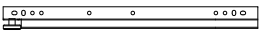

DR x3

Step 38

Étape 38

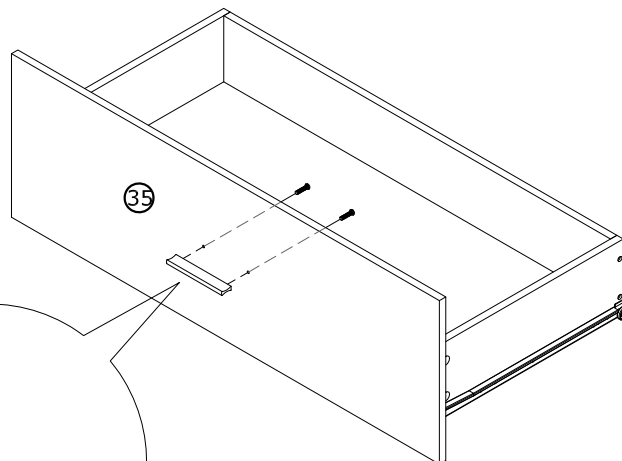

x3

I

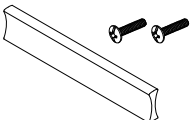

I x3

Assembly instructions / Instructions de montage

Step 39

Étape 39

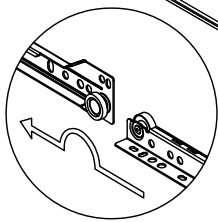
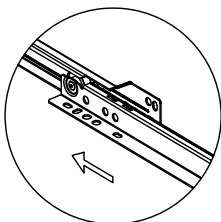
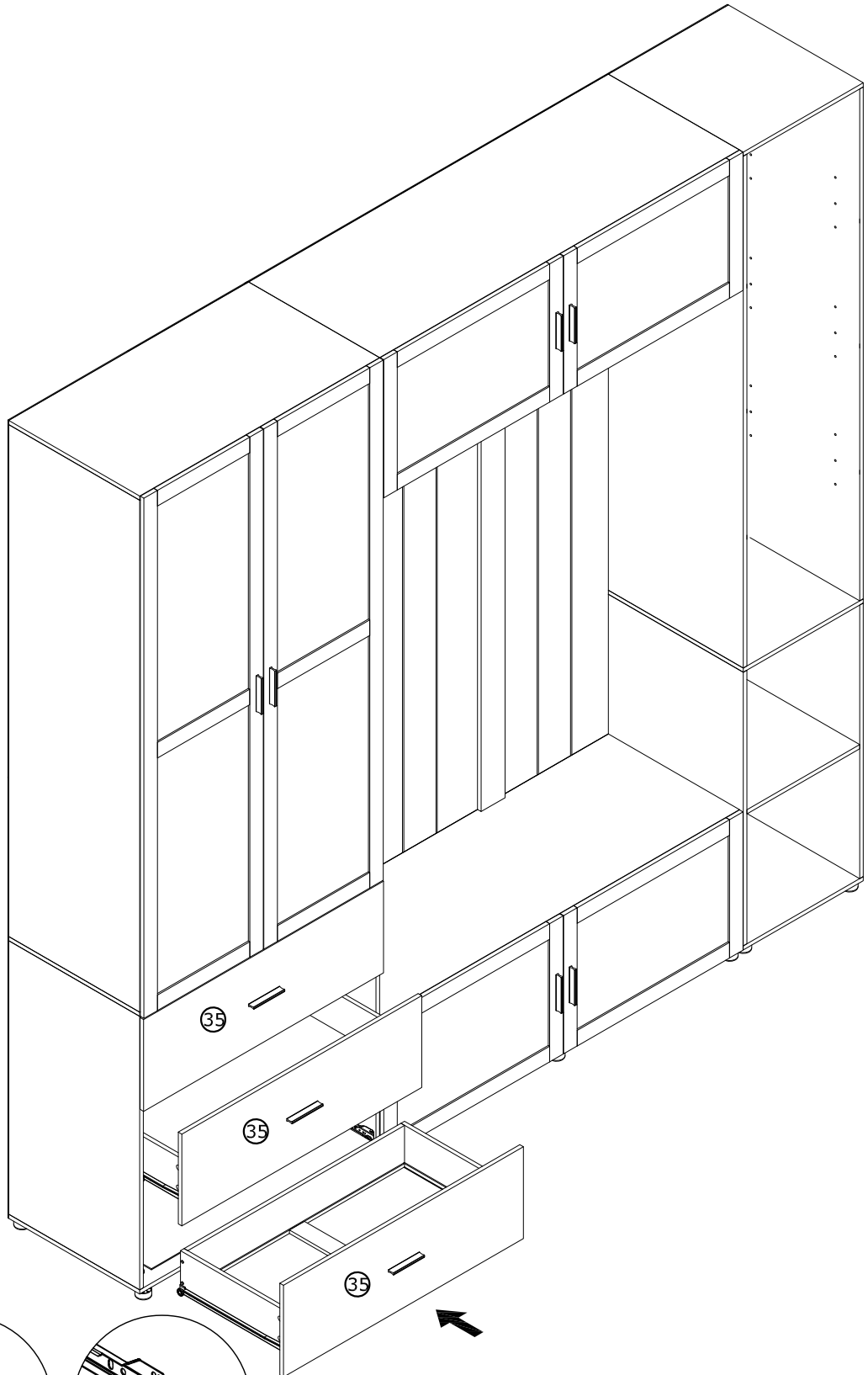

Assembly instructions / Instructions de montage

Step 40

Étape 40

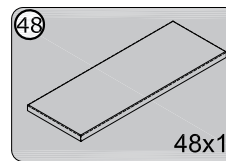
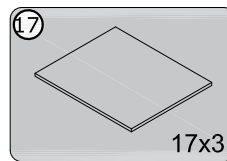

K



K x12

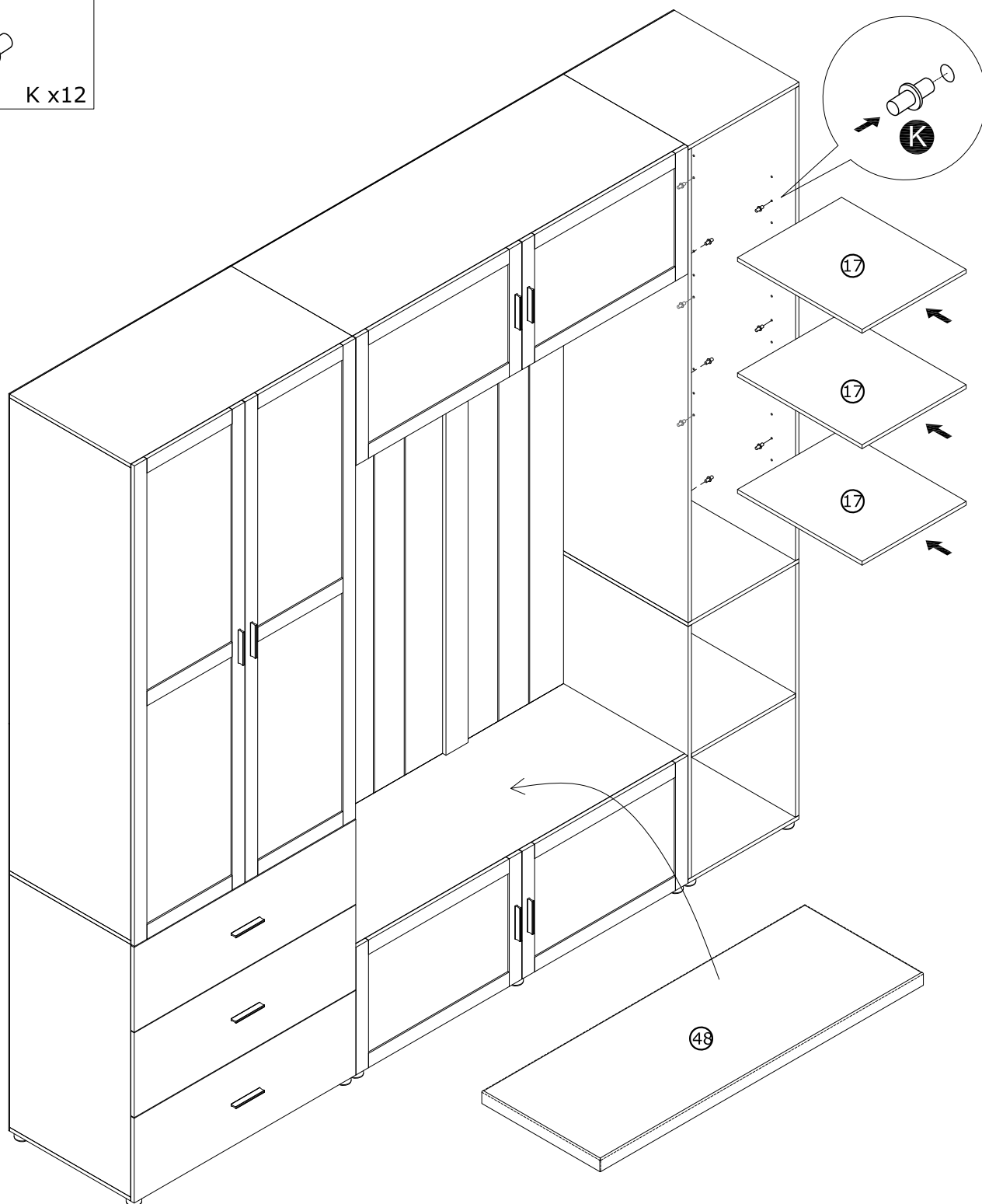

Assembly instructions / Instructions de montage

Step 41

Étape 41

N

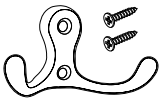

K x4

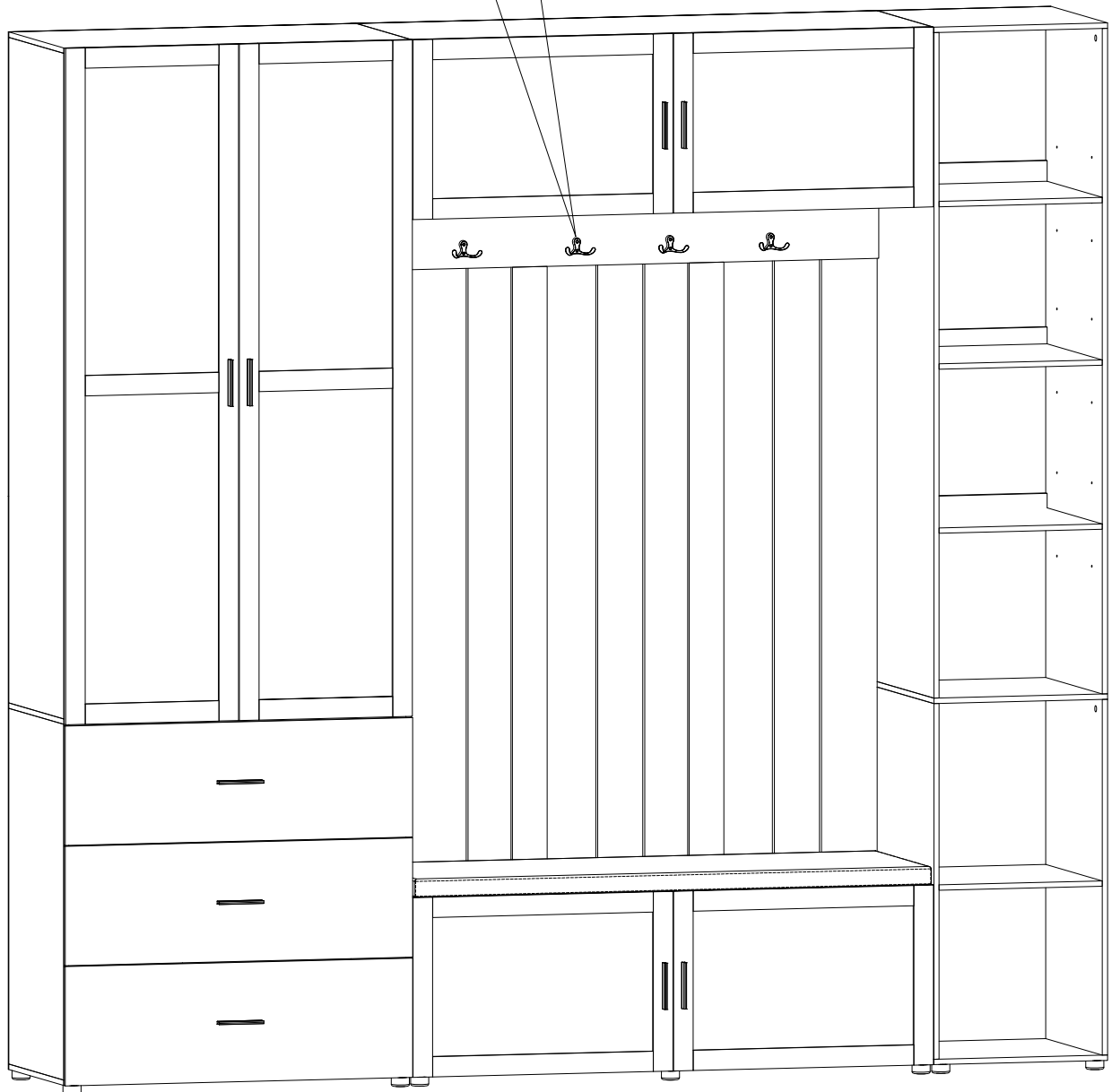
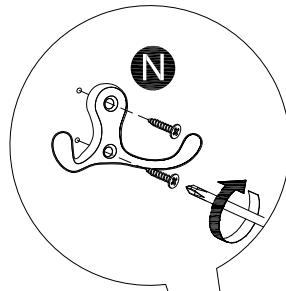

Assembly instructions / Instructions de montage

Step 42

Étape 42

