



PREMIER
COPPER PRODUCTS

MODEL NUMBER: VREC17SKBLK

- * Description: 17" Rectangle Skirted Vessel Hammered Copper Sink
- * Outer Dimension: 17" x 14" x 5"
- * Inner Dimension: 15" x 12"
- * Skirt: 2.5"
- * Drain Opening: 1.5"
- * Finish: Glazed Black

* BLK: Glazed Black

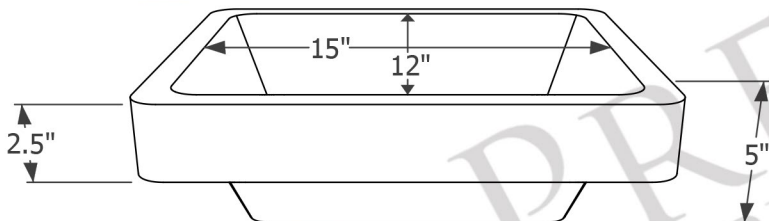
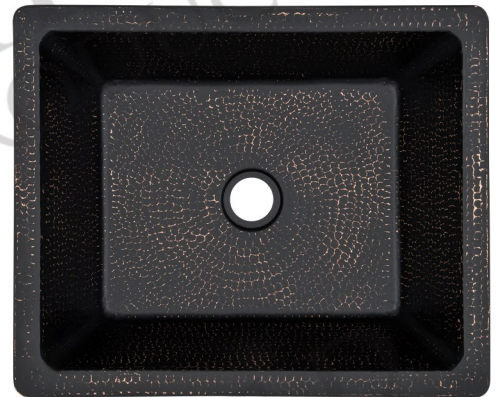
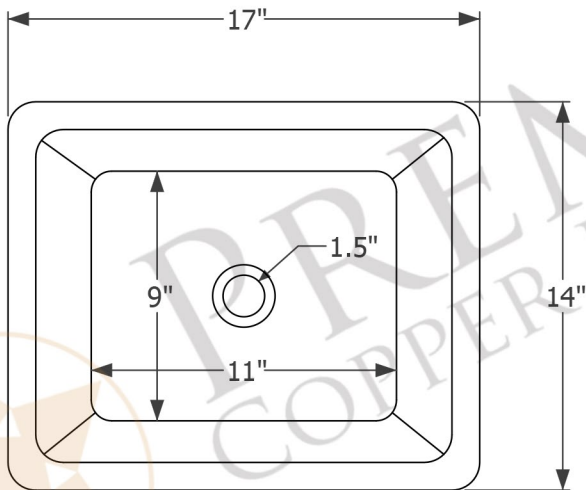

THIS PRODUCT IS HAND CRAFTED, SMALL VARIANCES IN COLOR AND SIZE MAY OCCUR.
DO NOT MAKE ANY INSTALLATION CUTS UNTIL YOU RECEIVE YOUR ITEM(S).