



### Features

- End drain.
- Bask® heated surface creates spa-like relaxation with soothing warmth on your back, shoulders, and neck.
- Integral lumbar support and armrests for comfort.
- Textured bottom surface.
- 60" (1524 mm) x 36" (914 mm) x 20" (508 mm)

### Material

- Acrylic

### Hydrotherapy

- Single-speed whirlpool offers 5 fully adjustable hydro-massage jets for water flow and direction.
- Pump with air switch for whirlpool.

### Installation

- Drop-in

### Recommended Accessories

- K-1278 Removable Apron
- K-7161-AF Bath Drain
- K-9695 5-Jet Trim Kit
- K-24916 Wireless Music Kit
- K-37380 30" Rough-in Cable Bath Drain
- K-37383 30" Rough-in Cable Bath Drain



### Codes/Standards





- ASME A112.19.7/CSA B45.10
- CSA B45.5/IAPMO Z124
- ASTM E162
- ASTM E662
- UL 1795
- Greenguard UL 2818 - Gold
- CARB P2

### KOHLER® One-Year Limited Warranty

See website for detailed warranty information.

### Available Color/Finishes

*Color tiles intended for reference only.*

Color	Code	Description
	0	White
	96	Biscuit
	47	Almond
	NY	Dune
	G9	Sandbar

No change in measurements if connected with drain illustrated. (K-7161-AF)

□ Recommended Faucet Location

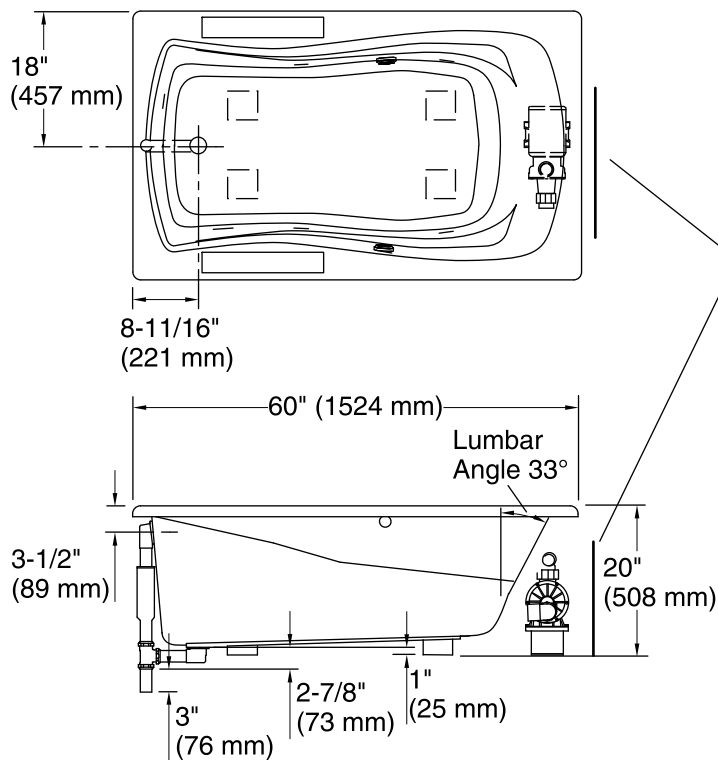

Pump/Control Access  
(If Apron Is Not Used)  
30" (762 mm) W x  
15" (381 mm) H Min

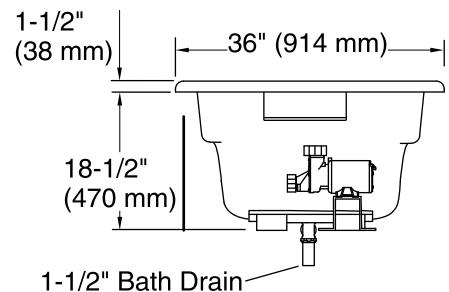
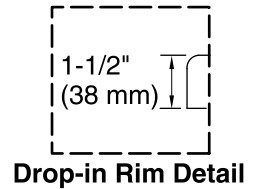

### Required Electrical Service

One dedicated circuit required, protected with Class A Ground-Fault Circuit-Interrupter (GFCI) or Residual Current Device (RCD).

Pump, Heated 120 V, 15 A, 60 Hz  
Surface:

### Technical Information

All product dimensions are nominal.

Installation:	Drop-in
Drain location:	End
Basin area, bottom:	46" x 24" (1168 mm x 610 mm)
Basin area, top:	54" x 27" (1372 mm x 686 mm)
Weight:	111 lbs (50.3 kg)
Minimum floor load:	44 lbs/ft <sup>2</sup> (214.8 kg/m <sup>2</sup> )
Water depth:	14" (356 mm)
Water capacity:	63 gal (238.5 L)
Cutout:	Drop-in, 58" x 34" (1473 mm x 864 mm)
Electrical component rating:	Pump: 120 V, 7 A, 60 Hz Heated Surface: 120 V, 0.5 A, 60 Hz, 65 W
Pump speed:	Single

### Notes

Measure your actual product for rough-in details.

Install this product according to the installation instructions.

The hot water supply should be 70% of the capacity of the bath or greater. Installations will vary.

Provide one grounded electrical outlet within 24" (610 mm) of each component.

If installing a rim-mount faucet, make sure there is no interference with drain overflow before drilling any holes. Consult local and national codes for minimum air gap requirements if installing a spout on the faucet deck.