

# ASSEMBLY INSTRUCTION

## SUNBED

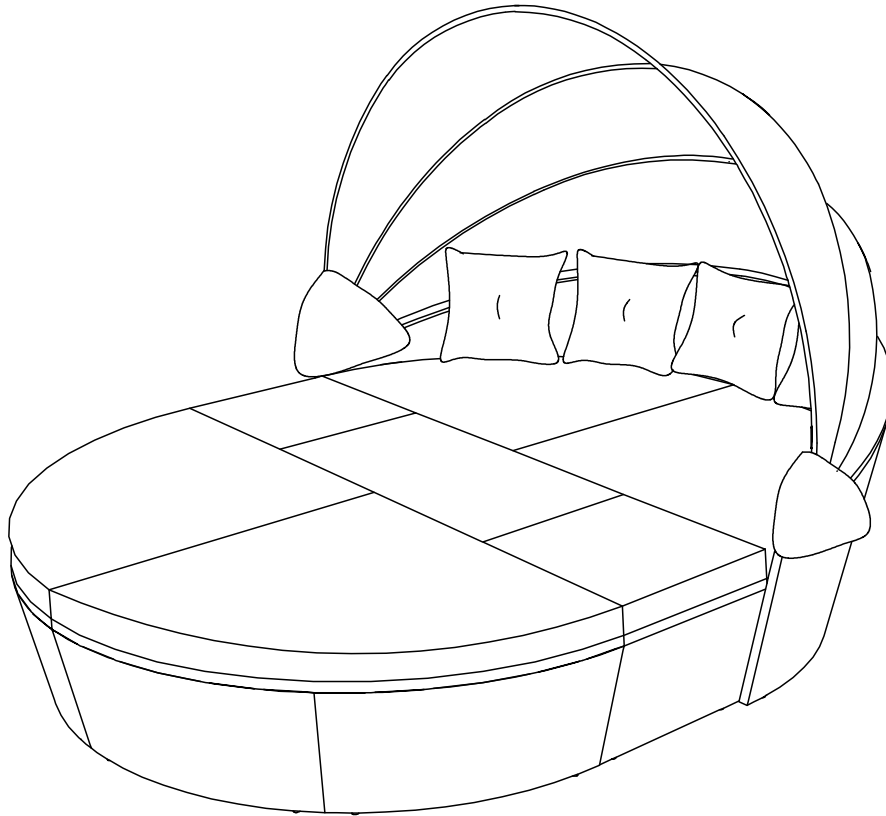

### WF322812, WF322813 WF322814

#### Notice:

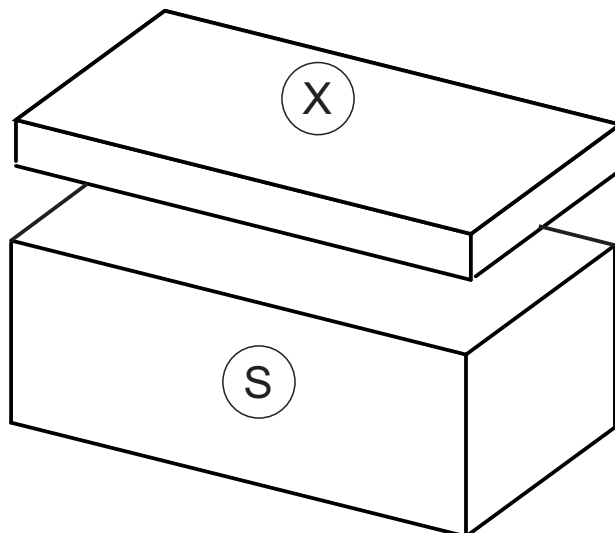
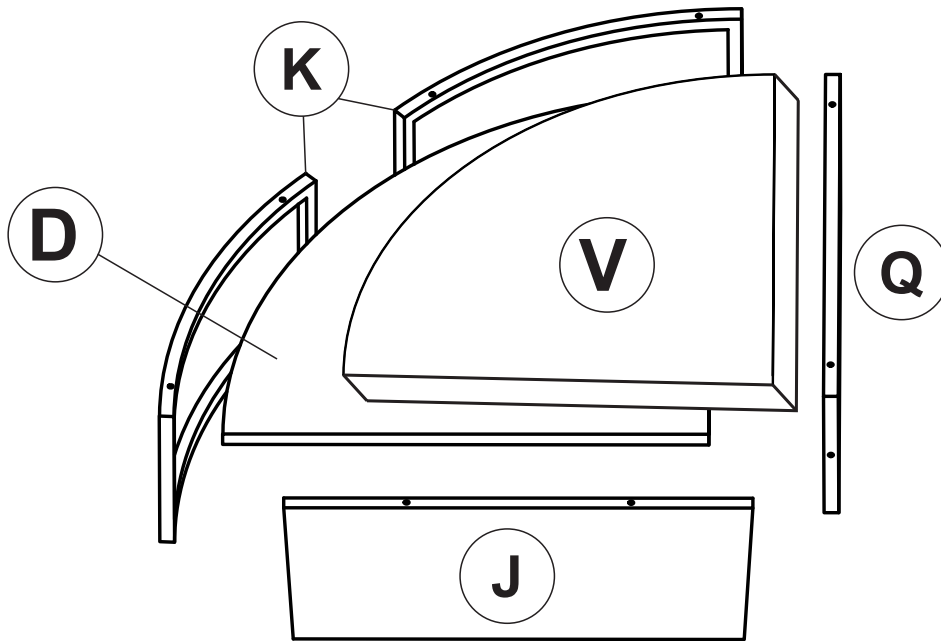
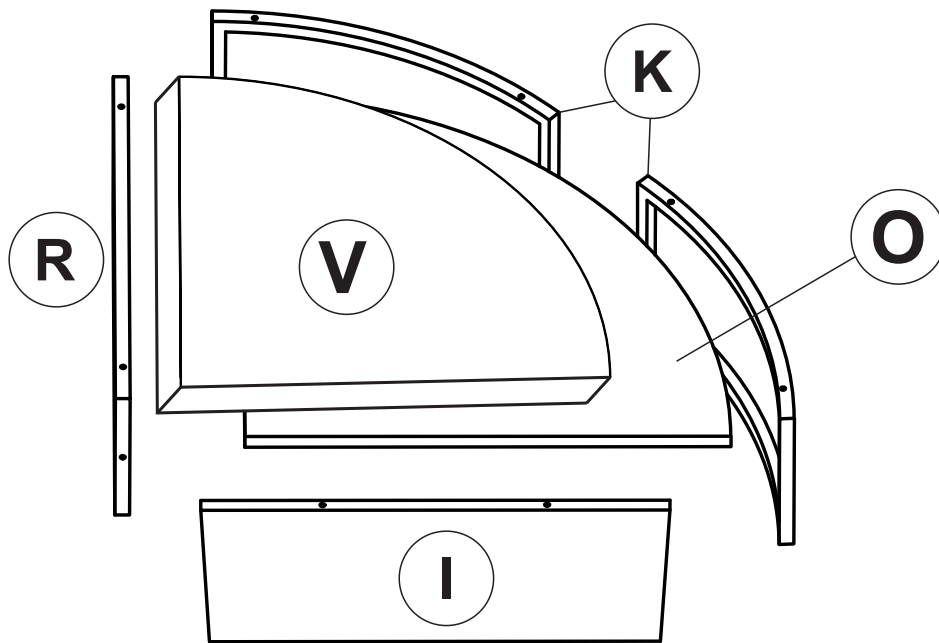

1. **50% Tighten before fixing all screws, Allen wrench is recommended instead of an electric drill.**
2. **Place the item on a flat ground to adjust and make sure it remains stable.**
3. **Tighten up all screws with tools gradually**
4. **If the screws are not aligned with holes during assembly please loosen all the other screws to 50% and continue the assembly process.**
5. **If the item is not stable, please loosen all the screws, adjust it on a flat ground and tighten up all screws again.**
6. **Note : If one or some screws are fully tightened during assembly, chances are the others will not be aligned with holes. In addition, all the holes are designed to be relatively larger to provide more space for the adjustment of the screws.**

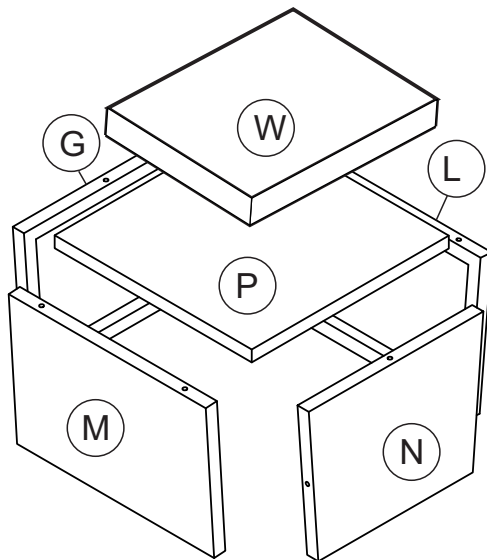



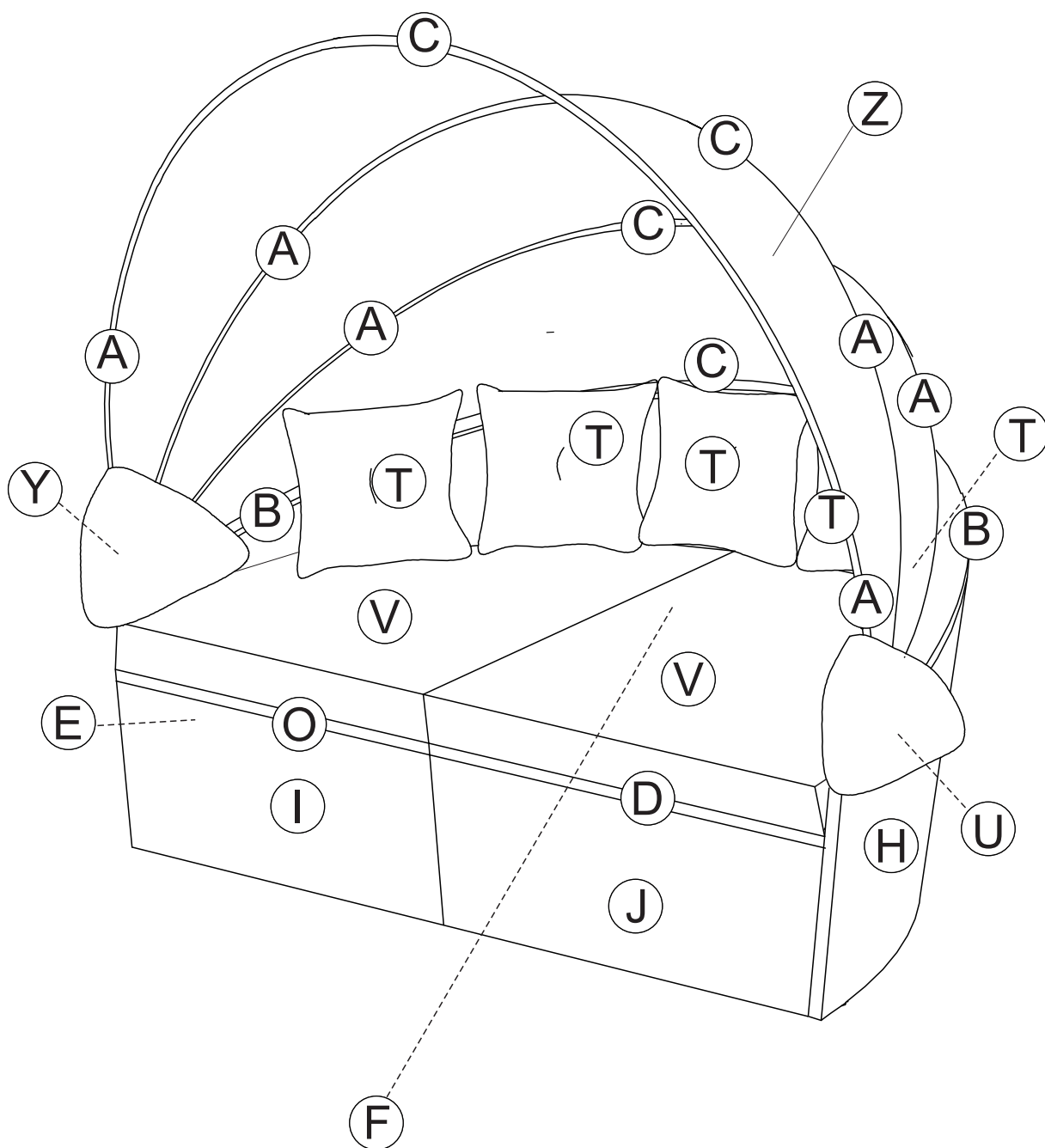



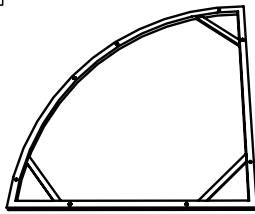
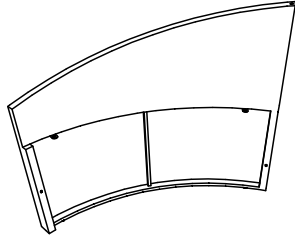
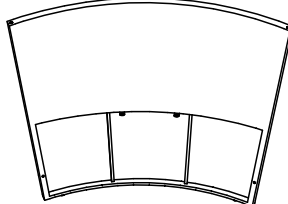
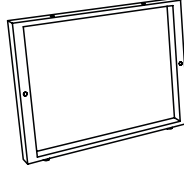
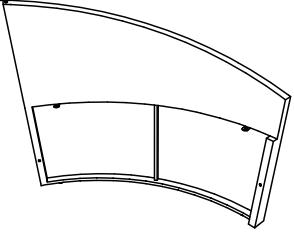
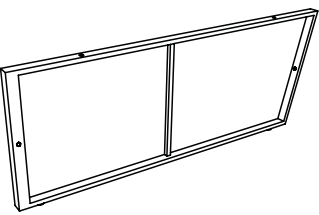
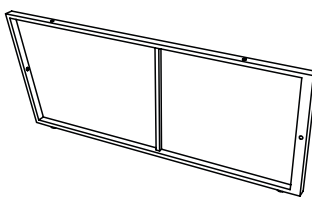
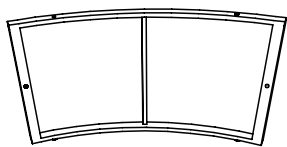
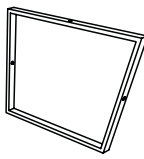
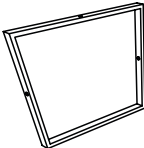
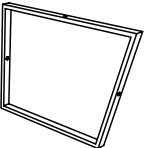
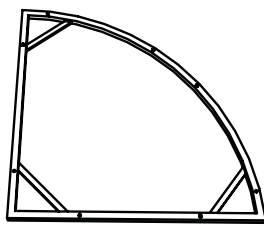
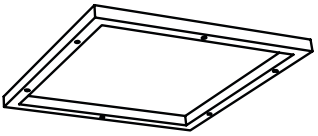
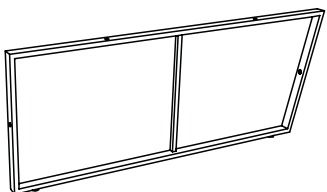
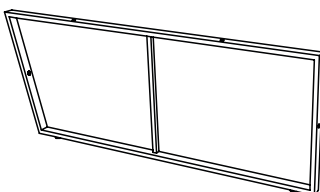
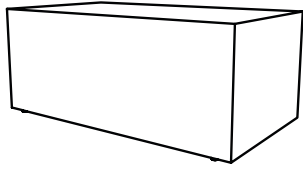
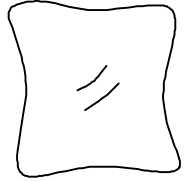
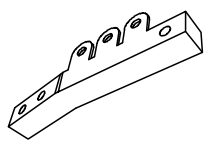
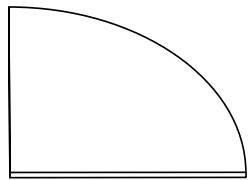
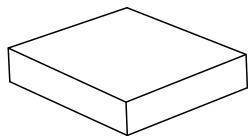
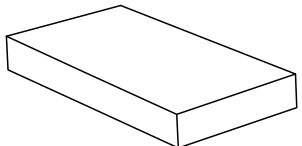

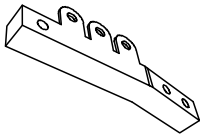
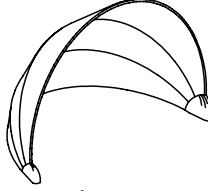
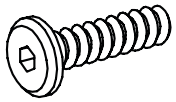
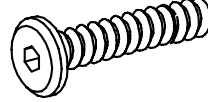
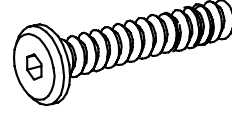
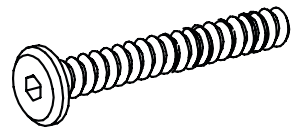
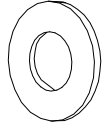

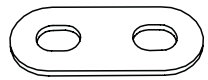
**X2**

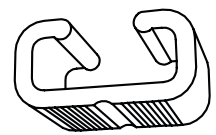

<p><b>A</b></p>  <p><b>6 pcs</b></p>	<p><b>B</b></p>  <p><b>2 pcs</b></p>	<p><b>C</b></p>  <p><b>4 pcs</b></p>	<p><b>D</b></p>  <p><b>2 pcs</b></p>
<p><b>E</b></p>  <p><b>1 pc</b></p>	<p><b>F</b></p>  <p><b>1 pc</b></p>	<p><b>G</b></p>  <p><b>2 pcs</b></p>	<p><b>H</b></p>  <p><b>1 pc</b></p>
<p><b>I</b></p>  <p><b>2 pcs</b></p>	<p><b>J</b></p>  <p><b>2 pcs</b></p>	<p><b>K</b></p>  <p><b>4 pcs</b></p>	<p><b>L</b></p>  <p><b>2 pcs</b></p>
<p><b>M</b></p>  <p><b>2 pcs</b></p>	<p><b>N</b></p>  <p><b>2 pcs</b></p>	<p><b>O</b></p>  <p><b>2 pcs</b></p>	<p><b>P</b></p>  <p><b>2 pcs</b></p>
<p><b>Q</b></p>  <p><b>1 pc</b></p>	<p><b>R</b></p>  <p><b>1 pc</b></p>	<p><b>S</b></p>  <p><b>1 pc</b></p>	<p><b>T</b></p>  <p><b>5 pcs</b></p>
<p><b>U</b></p>  <p><b>1 pc</b></p>	<p><b>V</b></p>  <p><b>4 pcs</b></p>	<p><b>W</b></p>  <p><b>2 pcs</b></p>	<p><b>X</b></p>  <p><b>1 pc</b></p>

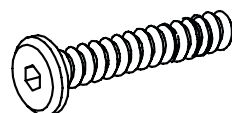
<p><b>Y</b></p>  <p>1 pc</p>	<p><b>Z</b></p>  <p>1 pc</p>		
<p><b>1</b></p>  <p>Bolt M6 X 20mm (24 pcs + Extra 2 pcs)</p>	<p><b>2</b></p>  <p>Bolt M6 X 30mm (48 pcs + Extra 2 pcs)</p>	<p><b>3</b></p>  <p>Bolt M6 X 35mm (10 pcs + Extra 1 pc)</p>	<p><b>4</b></p>  <p>Bolt M6 X 50mm (2 pcs)</p>
<p><b>5</b></p>  <p>Washer (100 pcs + Extra 5 pcs)</p>	<p><b>6</b></p>  <p>Plastic Washer 5mm (12 pcs + Extra 1 pc)</p>	<p><b>7</b></p>  <p>Nuts M6 (12 pcs + Extra 1 pc)</p>	<p><b>8</b></p>  <p>Steel Connector (9 pcs)</p>
<p><b>9</b></p>  <p>Screws (8 pcs + Extra 1 pc)</p>	<p><b>10</b></p>  <p>Gaslift 160N (2 pcs)</p>	<p><b>11</b></p>  <p>Allenkey 4mm (2 pcs)</p>	<p><b>12</b></p>  <p>Plastic Connector (7 pcs)</p>
<p><b>13</b></p>  <p>Wrench (2 pcs)</p>	<p><b>14</b></p>  <p>Bolt M6 X 40 (4 pcs)</p>		

# WF322812

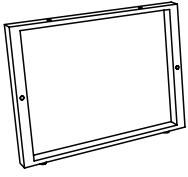

**G x2**

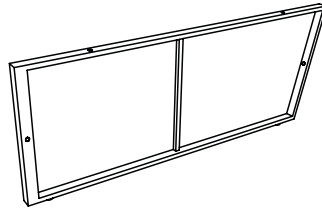

**I x2**

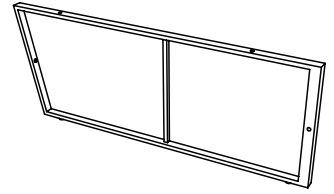

**J x2**

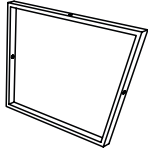

**L x2**

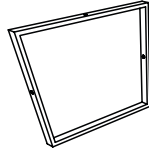

**M x2**

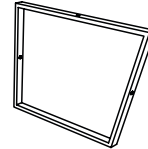

**N x2**

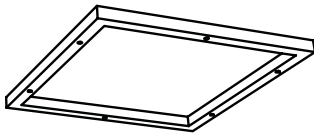

**P x2**

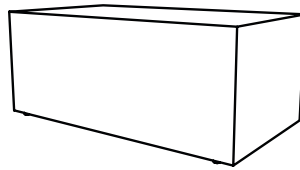

**S x1**

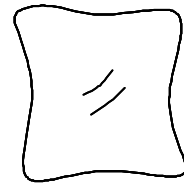

**T x2**

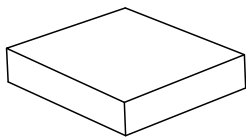

**W x2**

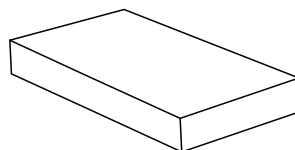

**X x1**

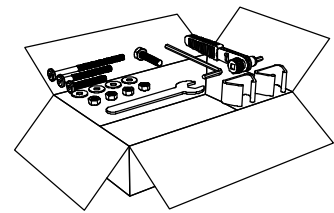

**Hardware**

# WF322813



**A x6**



**B x2**



**C x4**

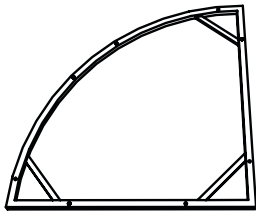

**D x2**

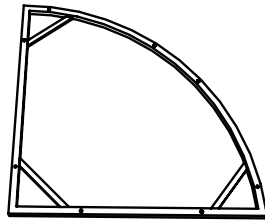

**O x2**

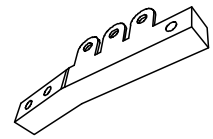

**U x1**

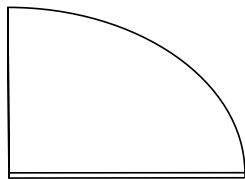

**V x4**

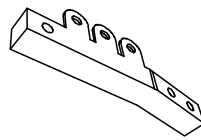

**Y x1**

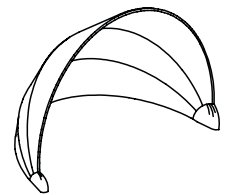

**Z x1**

# WF322814

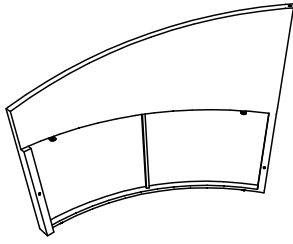

**E x1**

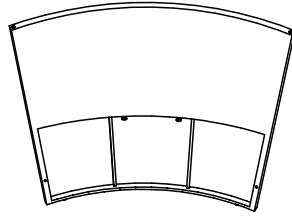

**F x1**

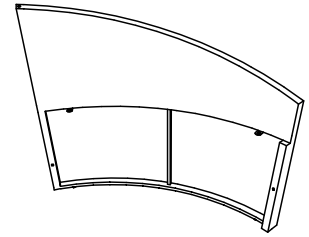

**H x1**

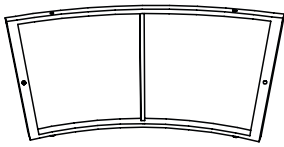

**K x4**

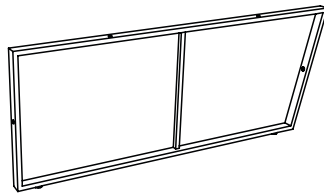

**Q x1**

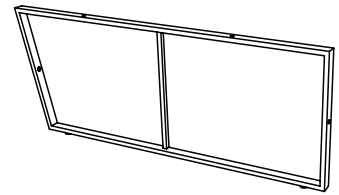

**R x1**

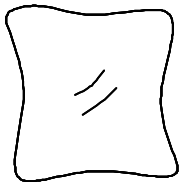

**T x3**



# STEP 1

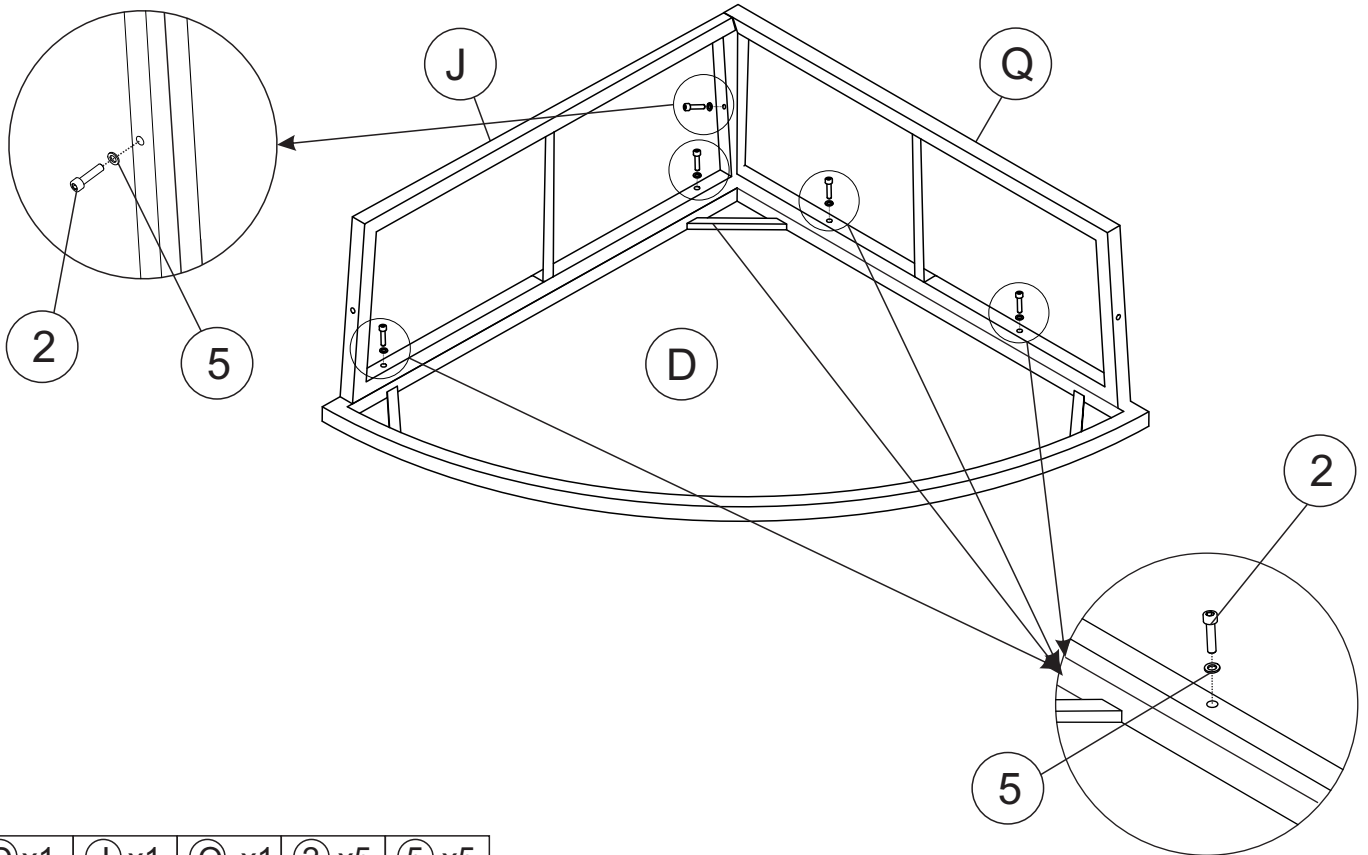
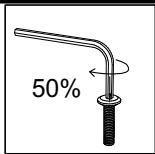

- ⓓ x1
- ⓐ x1
- Ⓠ x1
- ⓐ x5
- Ⓟ x5

# STEP 2

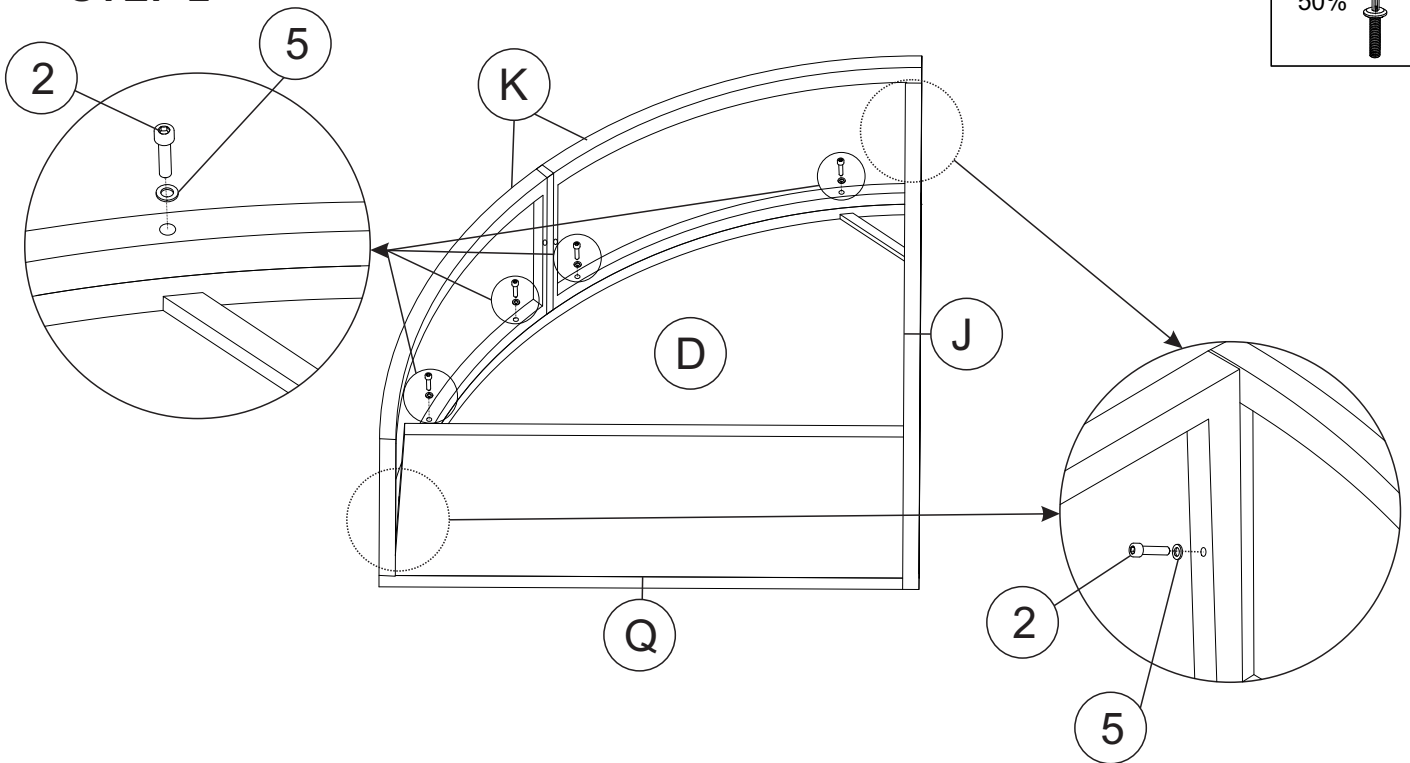
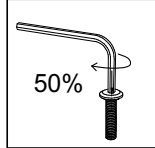

- Ⓚ x2
- ⓐ x6
- Ⓟ x6

### STEP 3

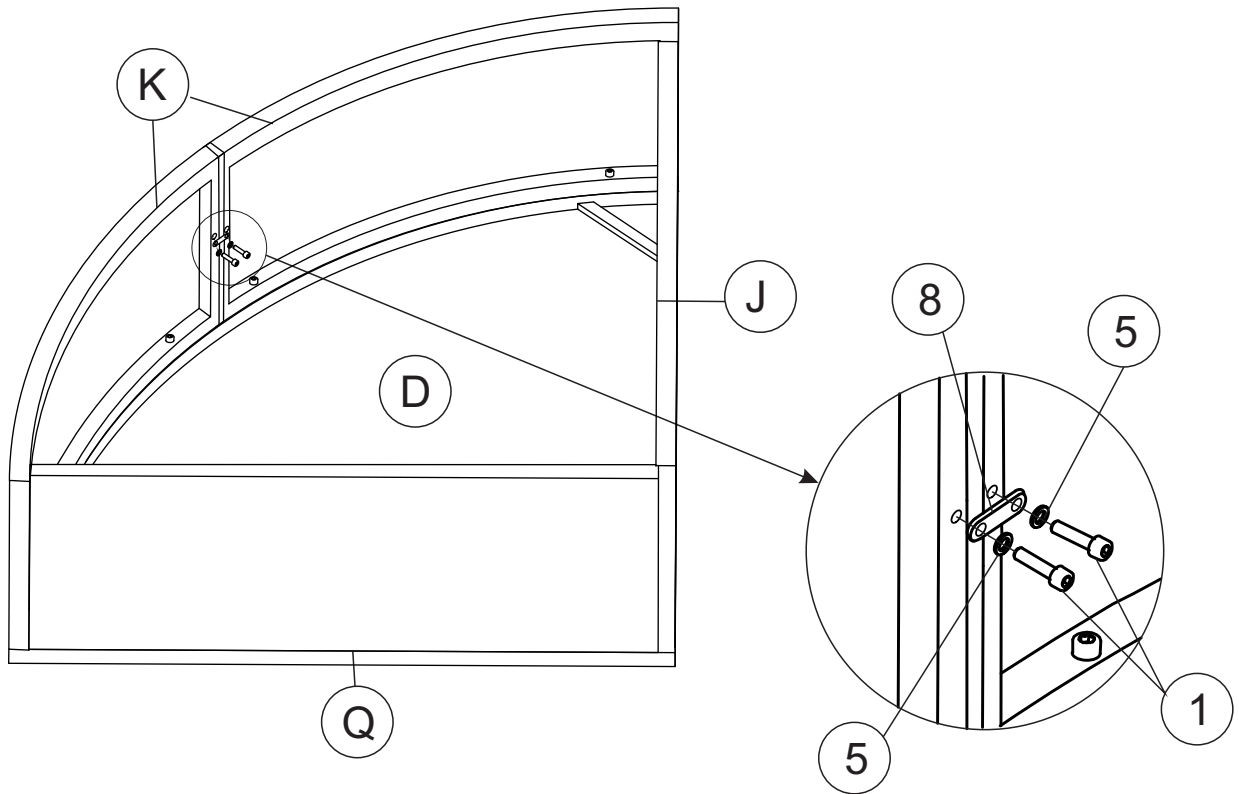
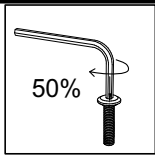

- ① x2
- ⑤ x2
- ⑧ x1

### STEP 4

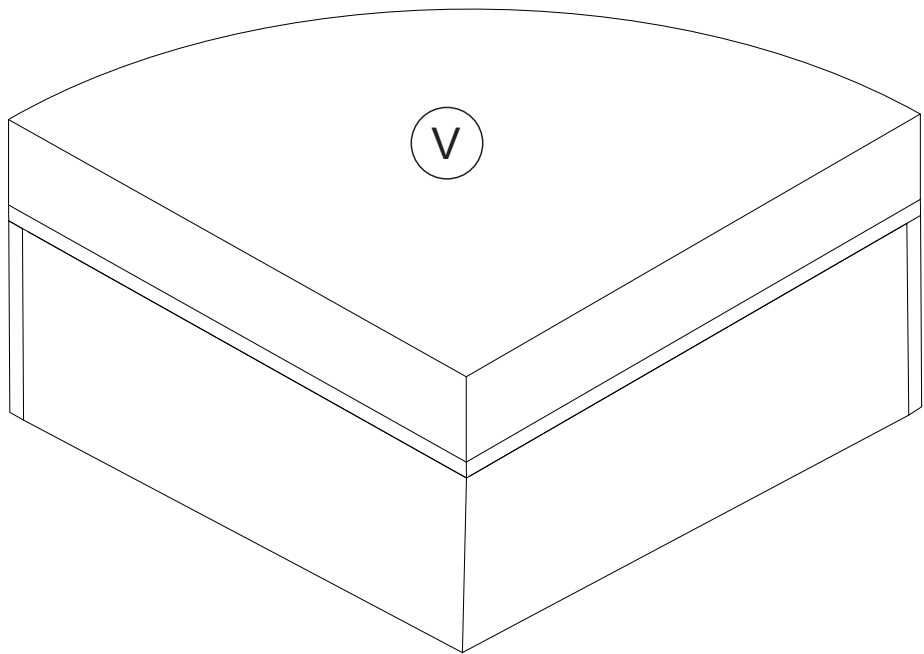

Tighten all bolts 100%

- Ⓥ x1

# STEP 5

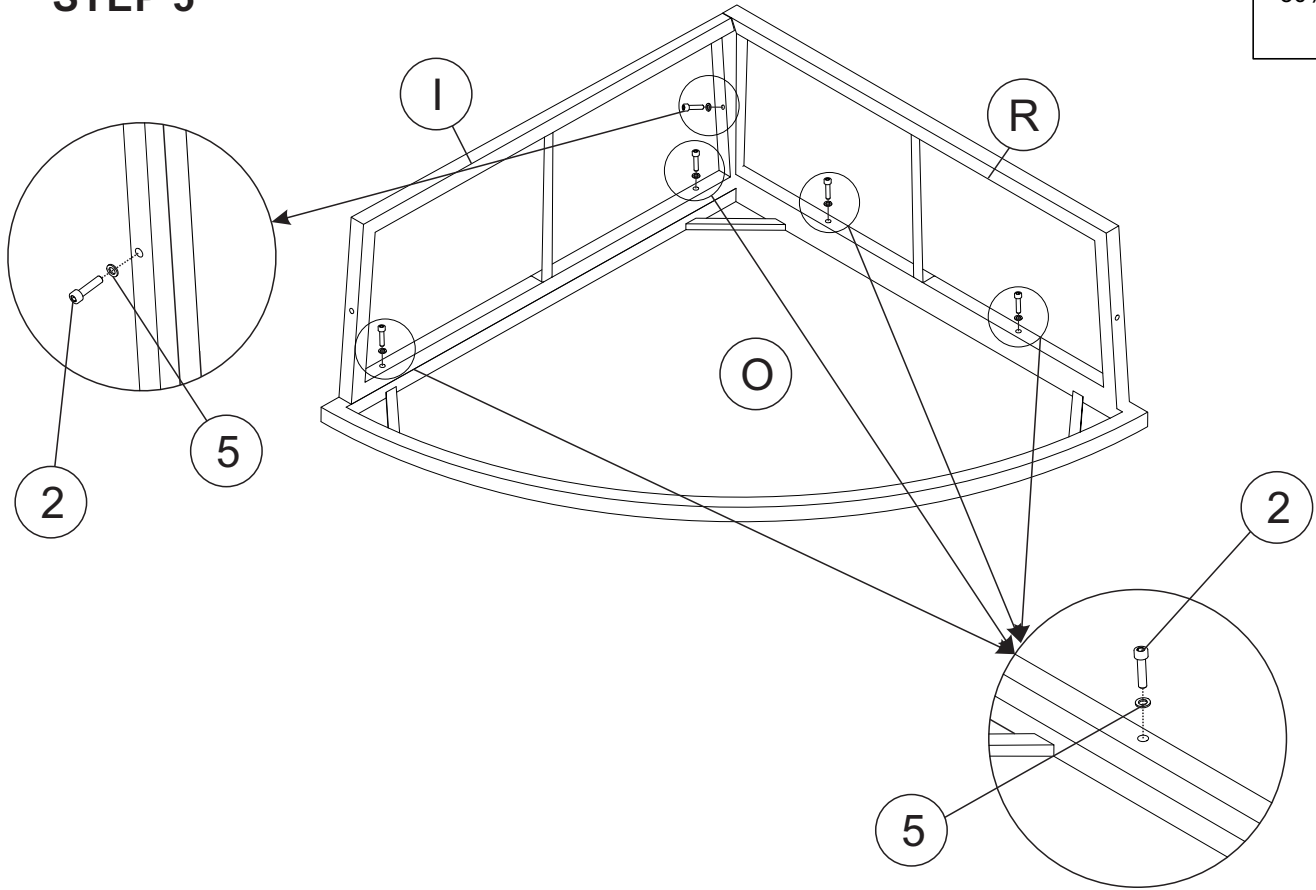
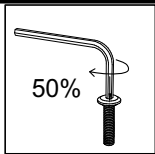

- ⓪ x1
- ① x1
- Ⓡ x1
- ② x5
- ⑤ x5

# STEP 6

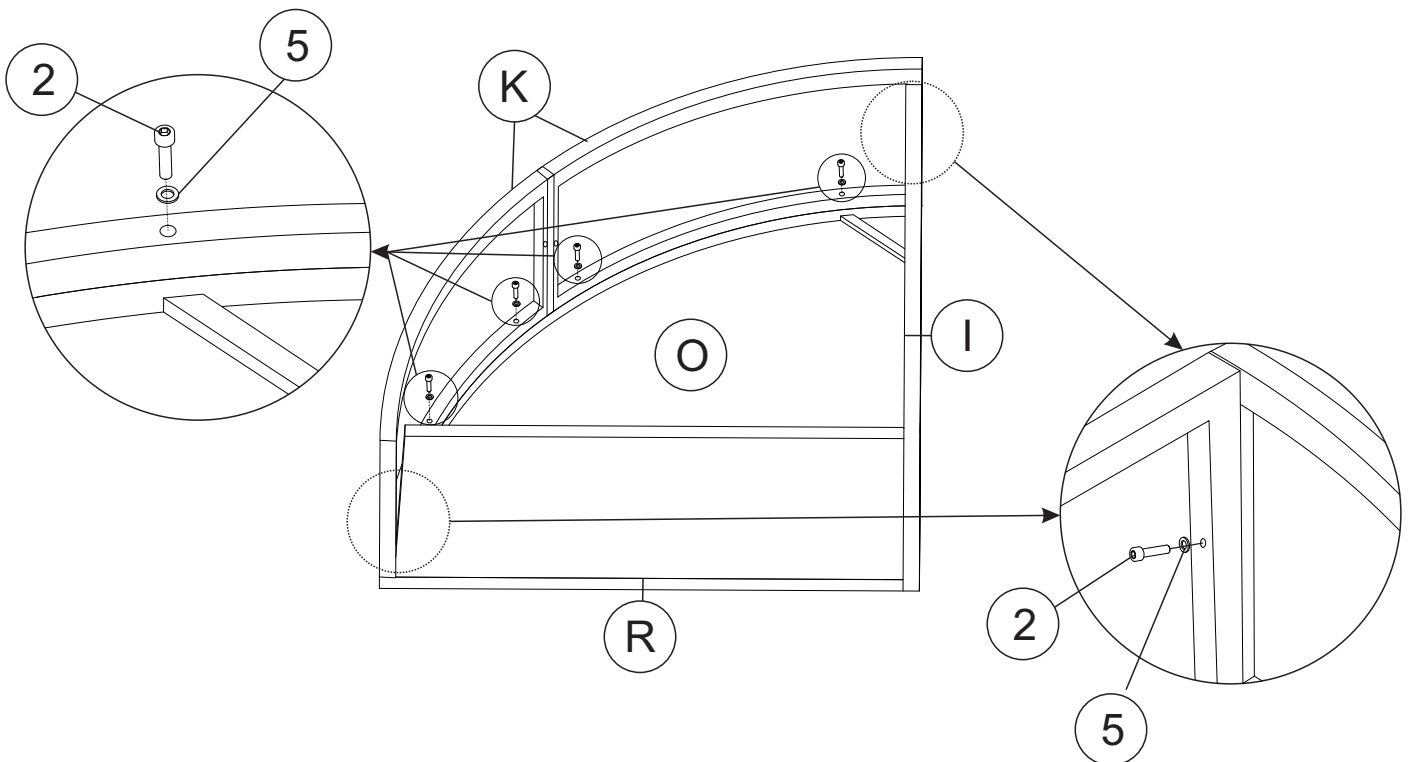
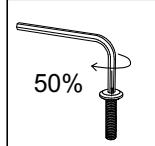

- Ⓚ x2
- ② x6
- ⑤ x6

# STEP 7

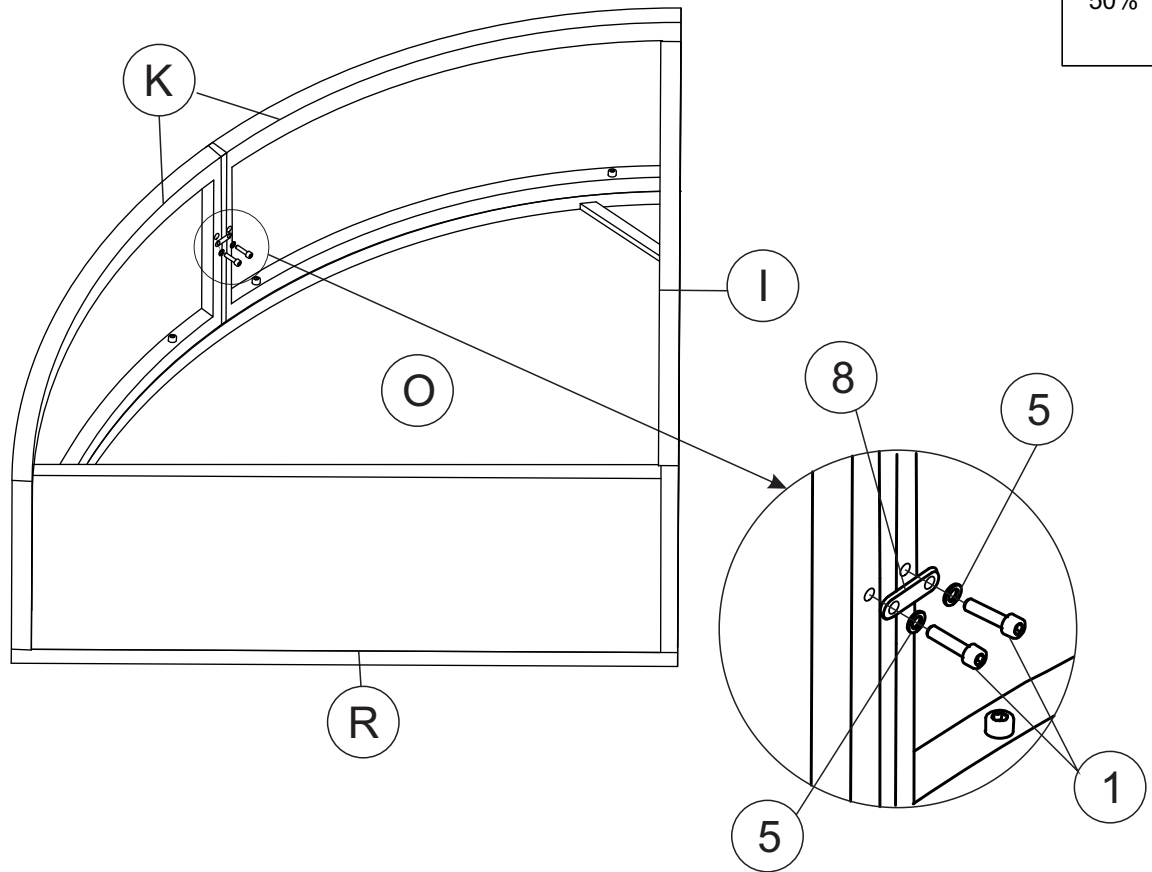

- ① x2
- ⑤ x2
- ⑧ x1

# STEP 8

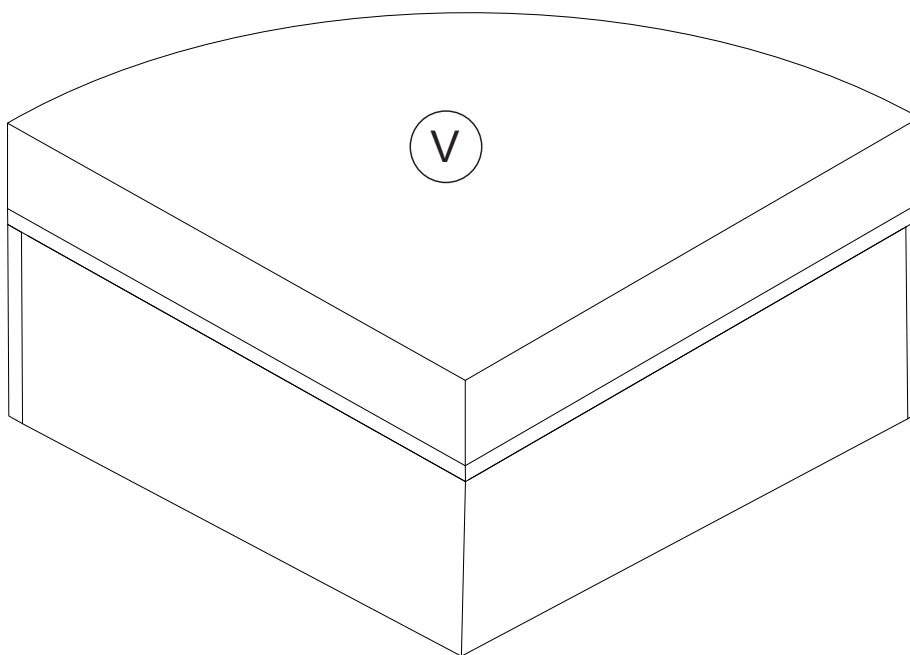

Tighten all bolts 100%

- Ⓥ x1

# STEP 9

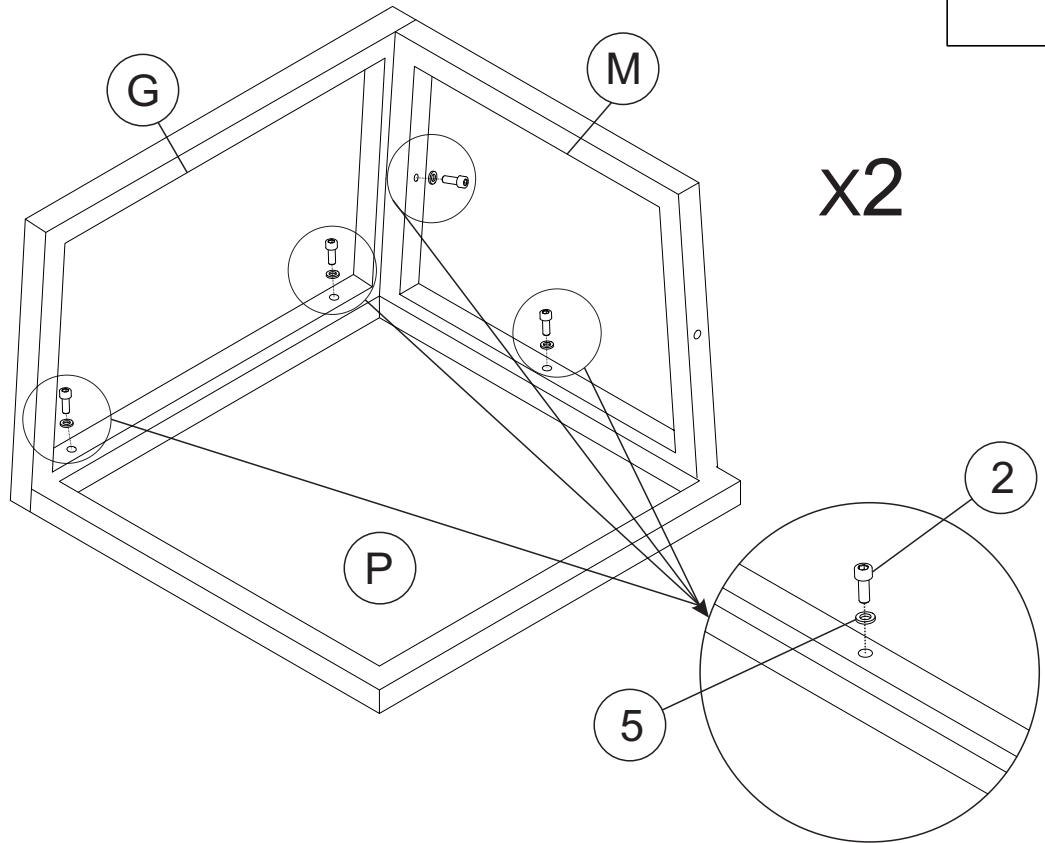
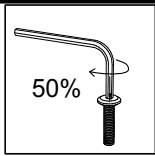

- Ⓟ x2
- ⓐ x2
- Ⓜ x2
- Ⓣ x8
- Ⓟ x8

# STEP 10

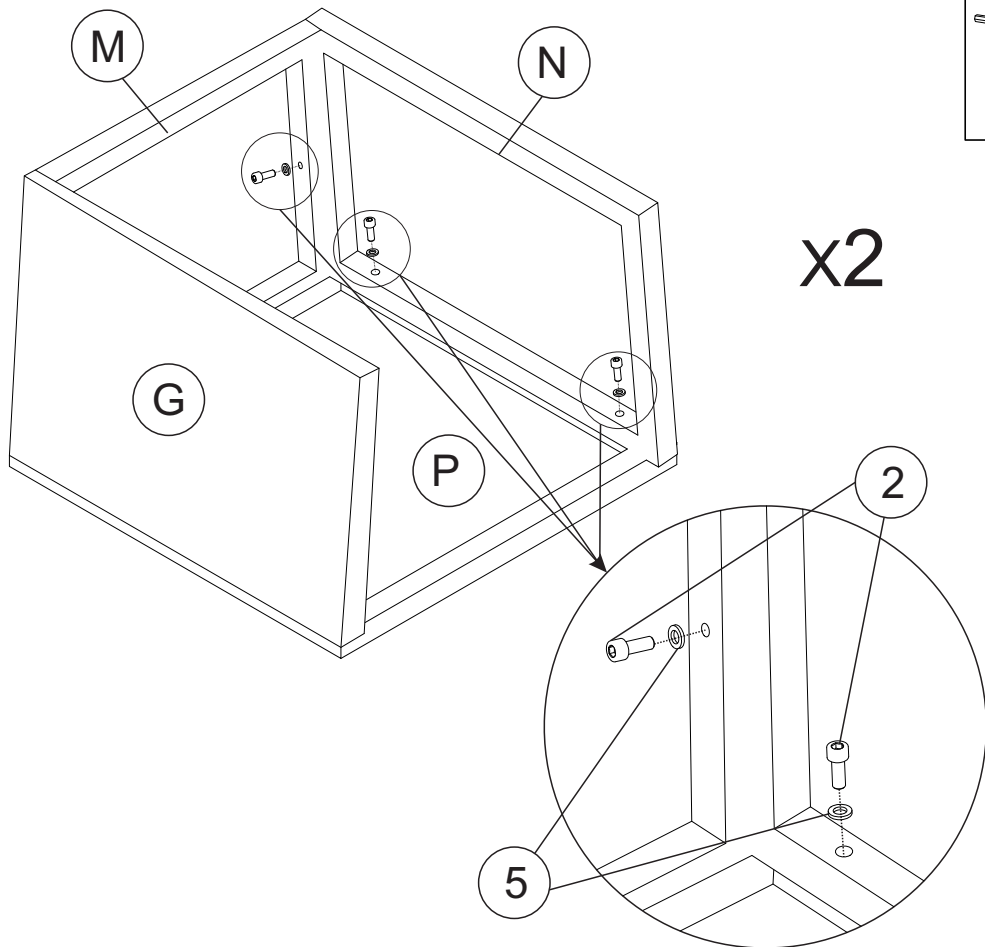
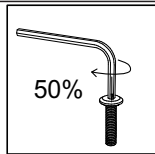

- Ⓝ x2
- Ⓣ x6
- Ⓟ x6

STEP 11

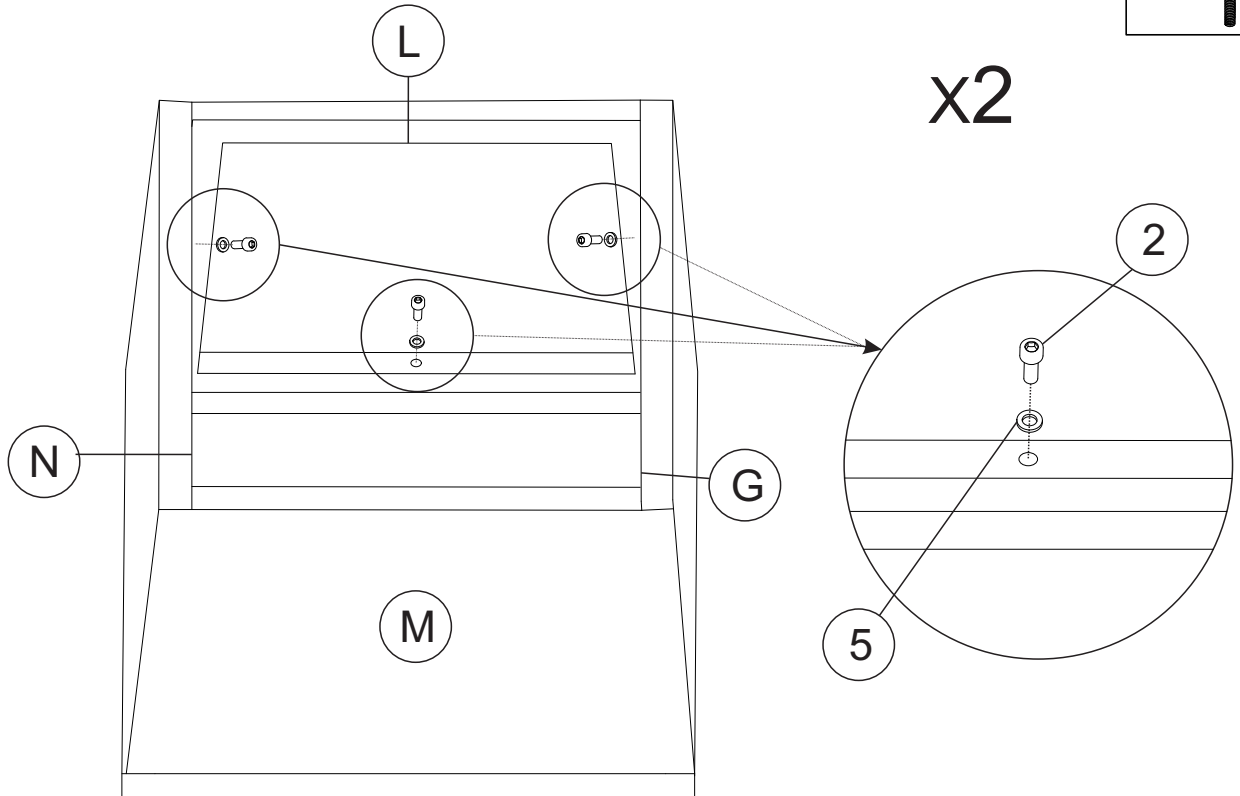
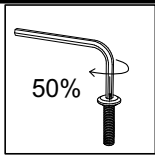

- Ⓛ x2
- ② x6
- ⑤ x6

STEP 12

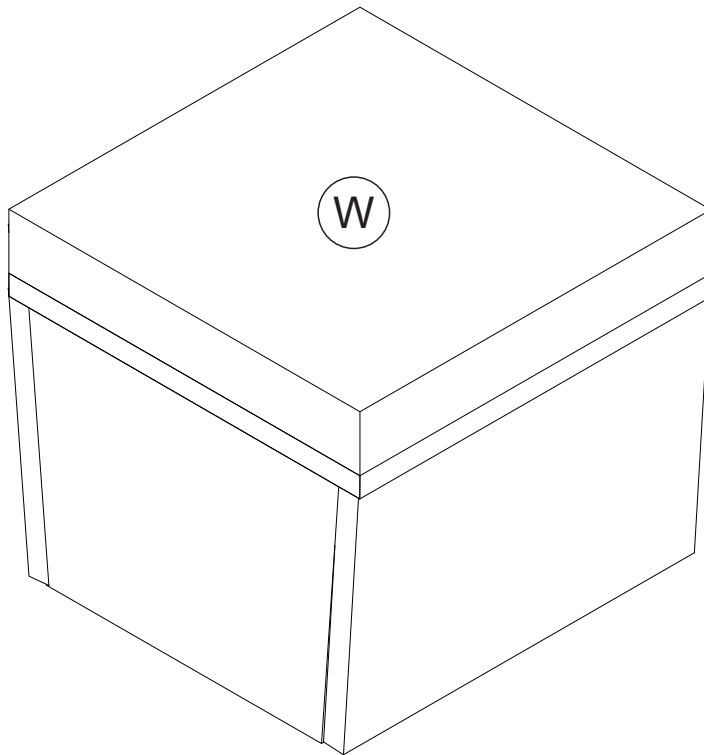
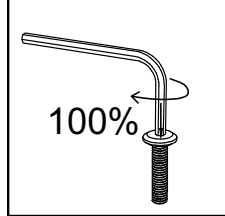

Tighten all bolts 100%

- Ⓜ x2

# STEP 13

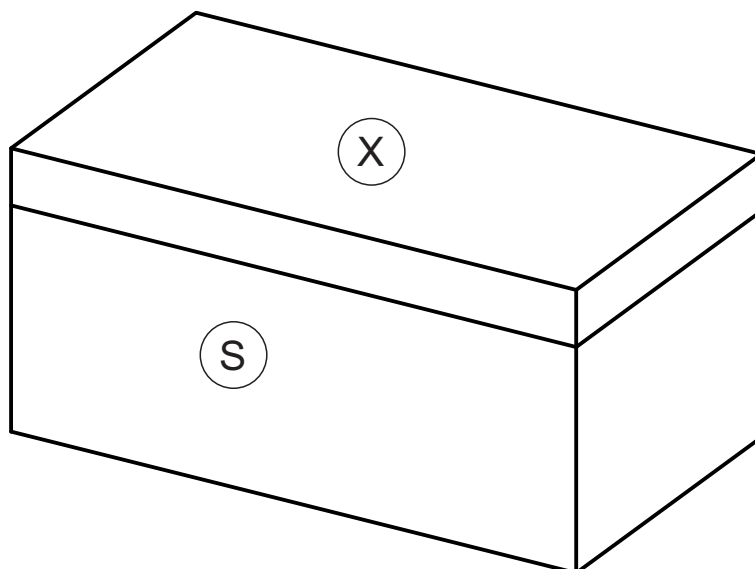

Ⓢx1   ⓧx1

# STEP 14

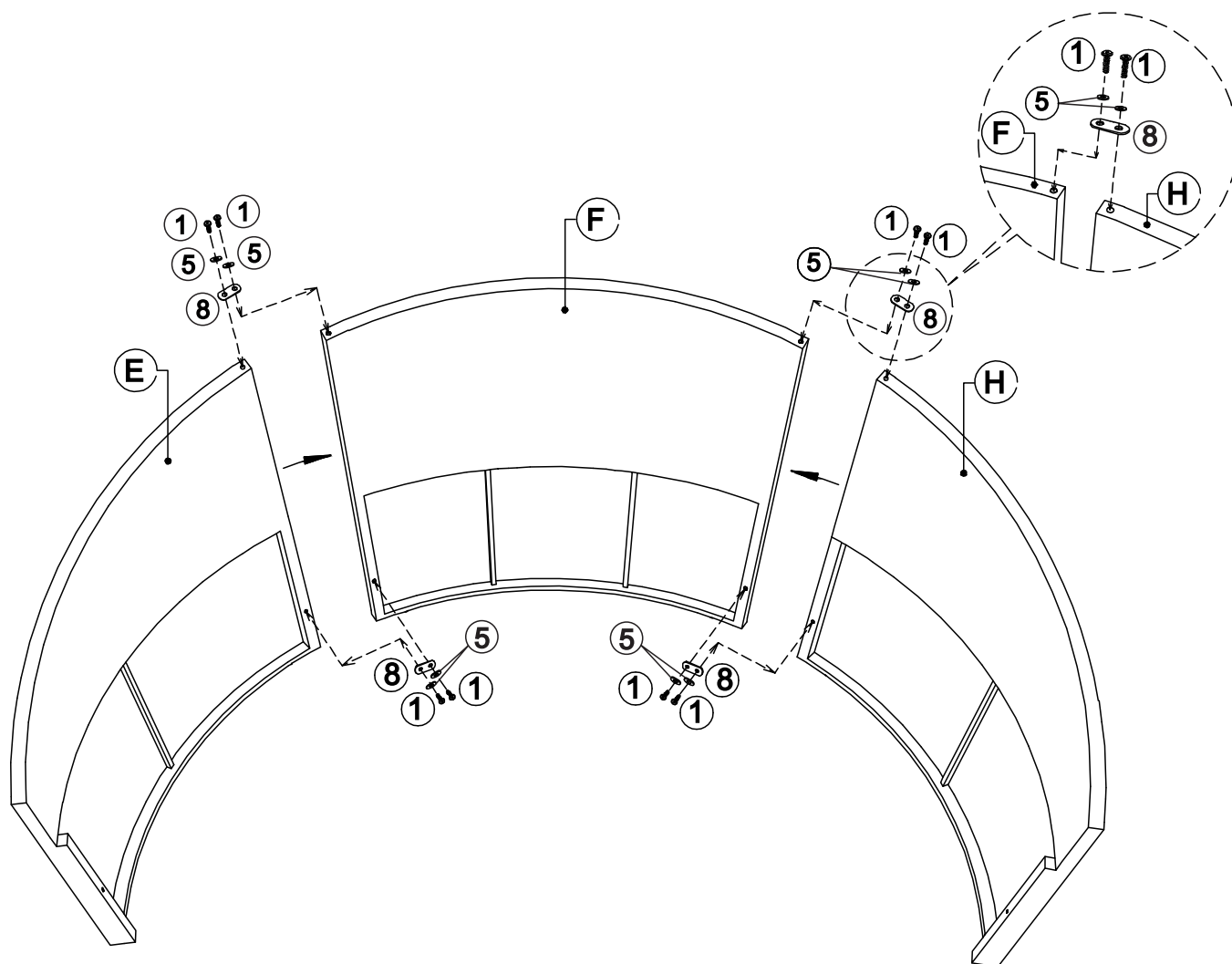
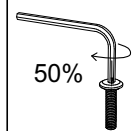

Ⓔx1   Ⓕx1   Ⓖx1   ①x8   ⑤x8   ⑧x4

# STEP 15

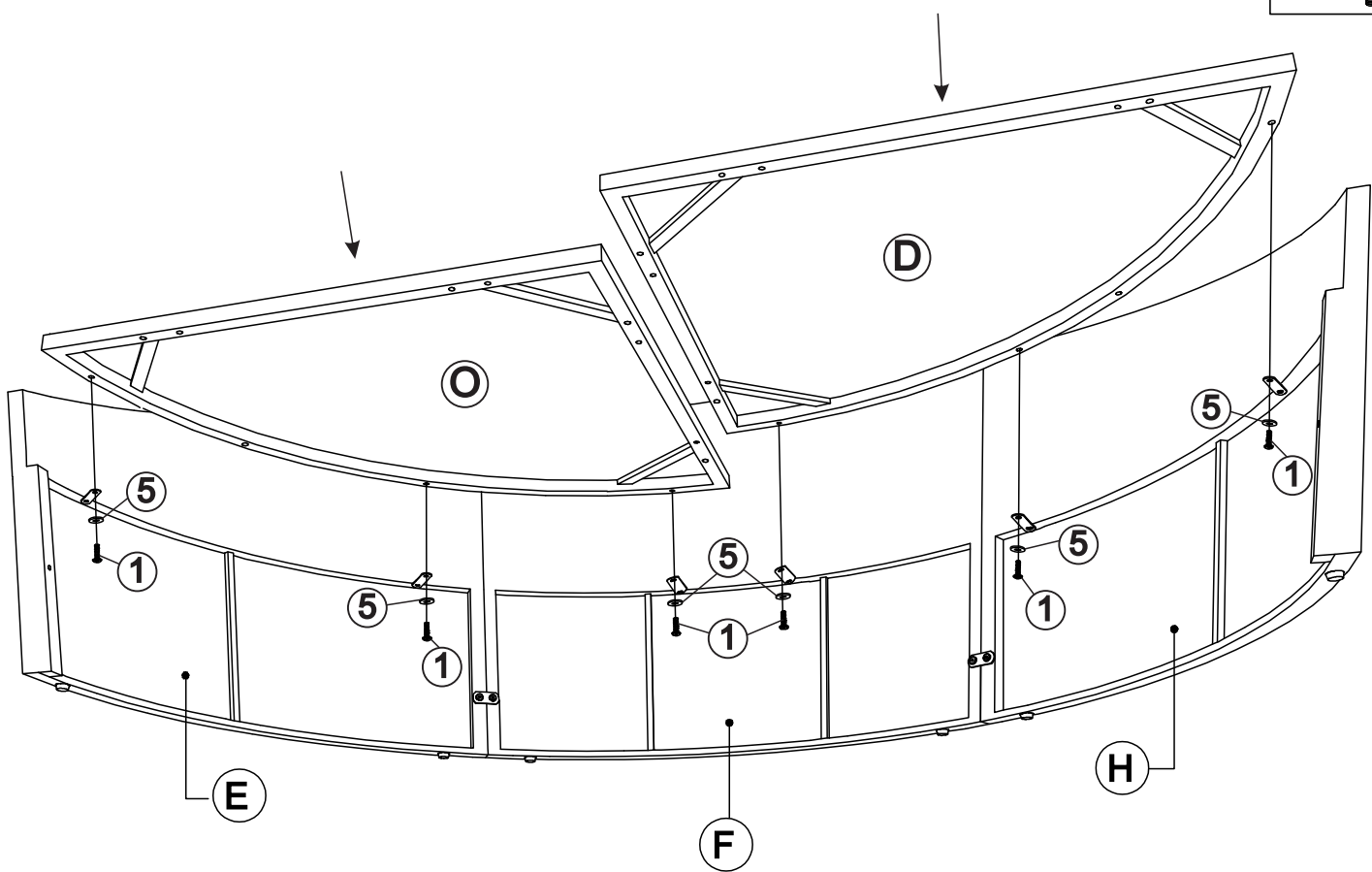
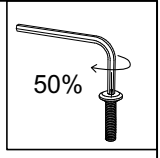

- D** x1
- O** x1
- 1** x6
- 5** x6

# STEP 16

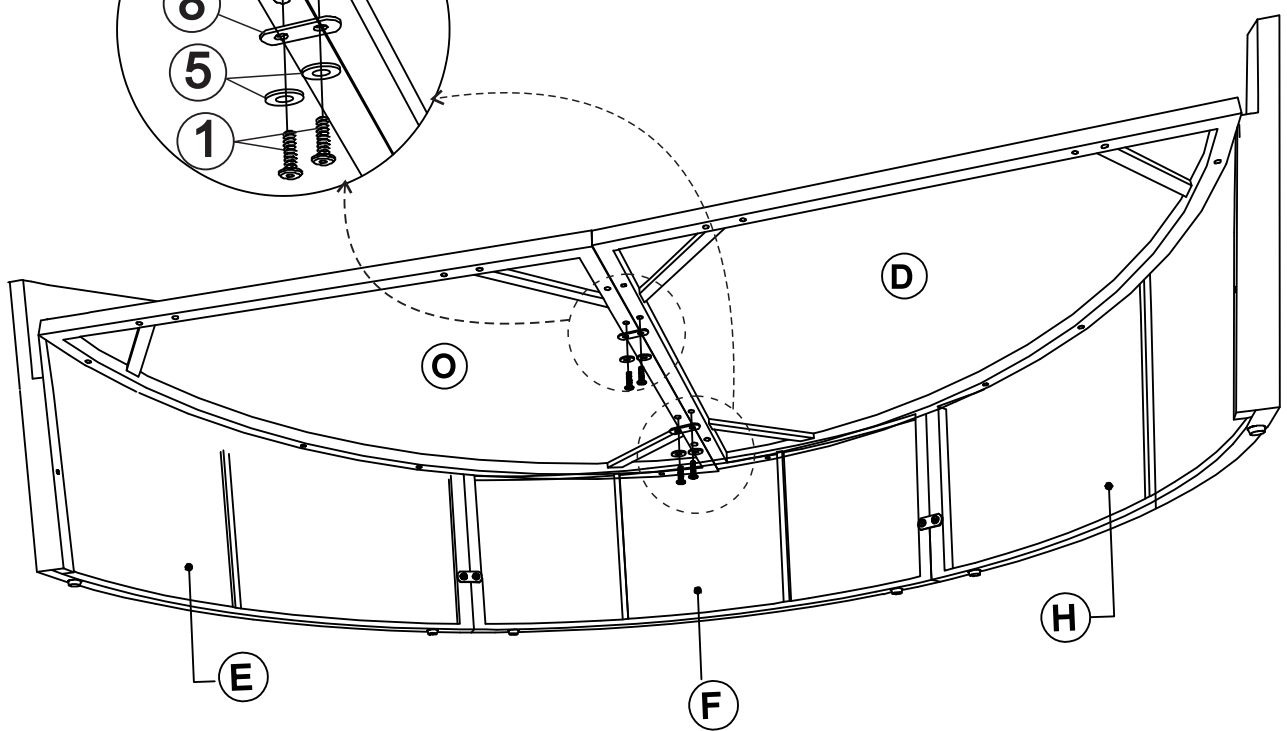
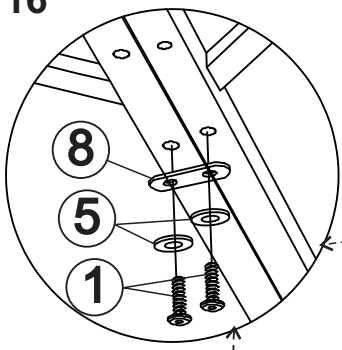
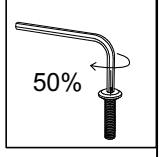

- 1** x4
- 5** x4
- 8** x2



# STEP 17

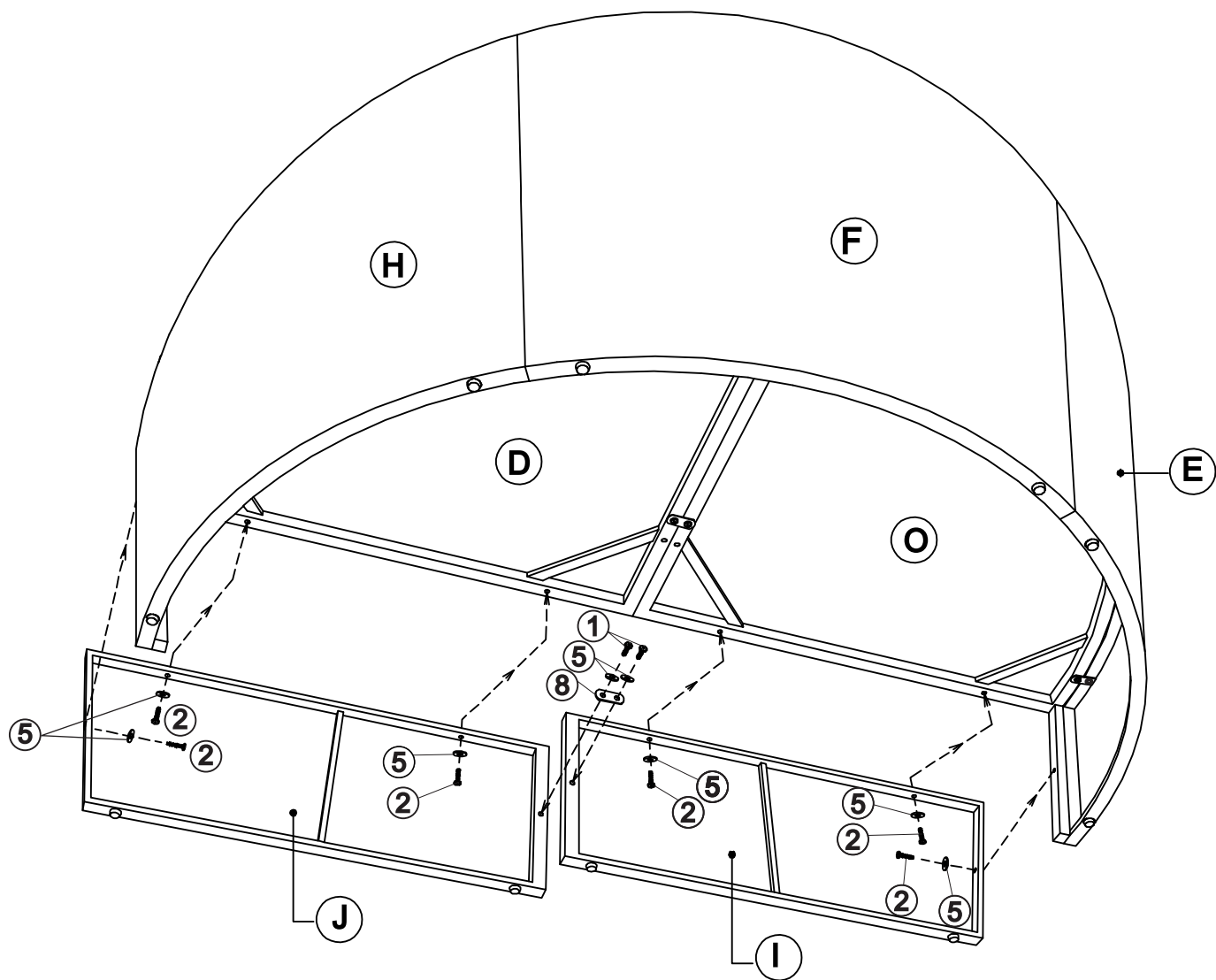
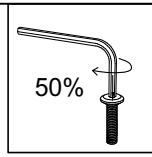

- ① x1
- ② x6
- ③ x1
- ④ x2
- ⑤ x8
- ⑥ x1

# STEP 18

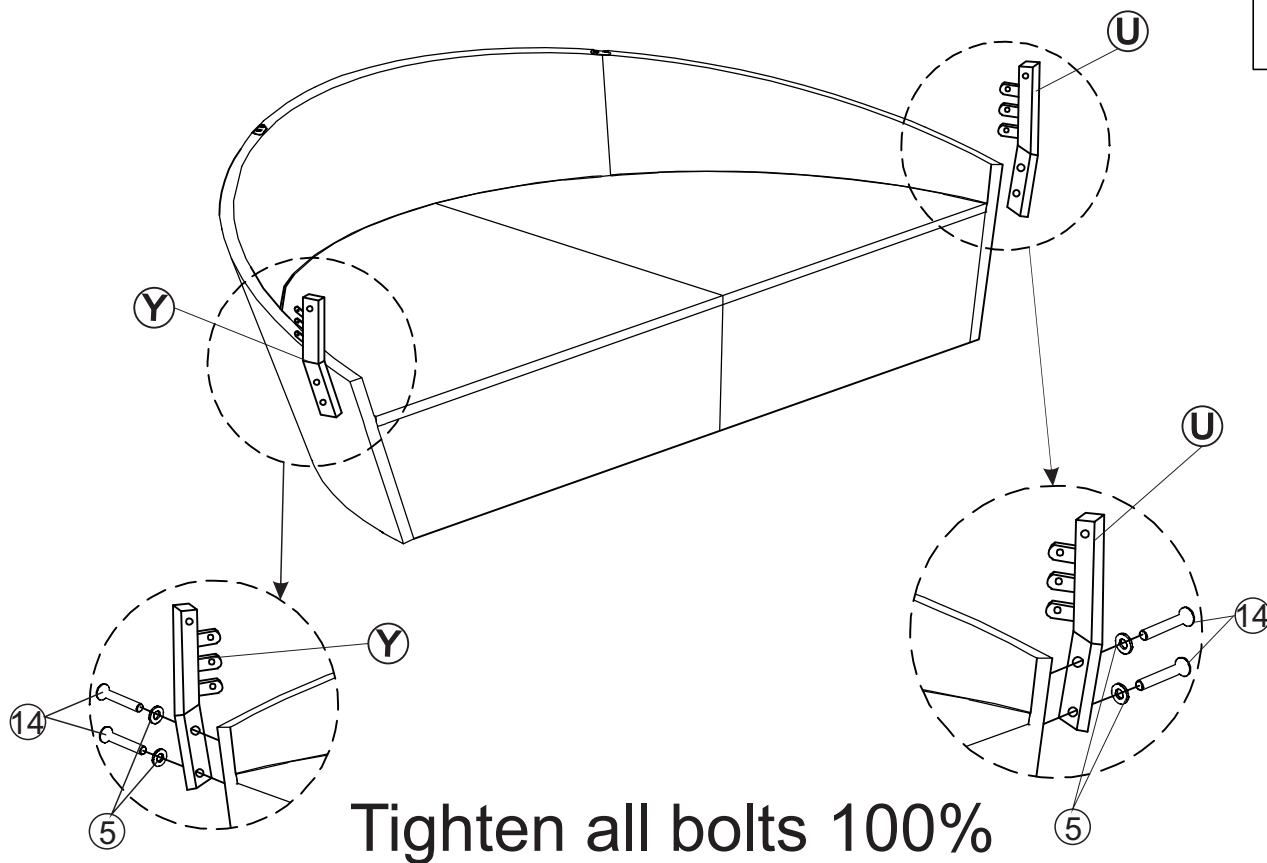

Tighten all bolts 100%

- U x1
- Y x1
- 14 x4
- 5 x4

# STEP 19

## Part A x3

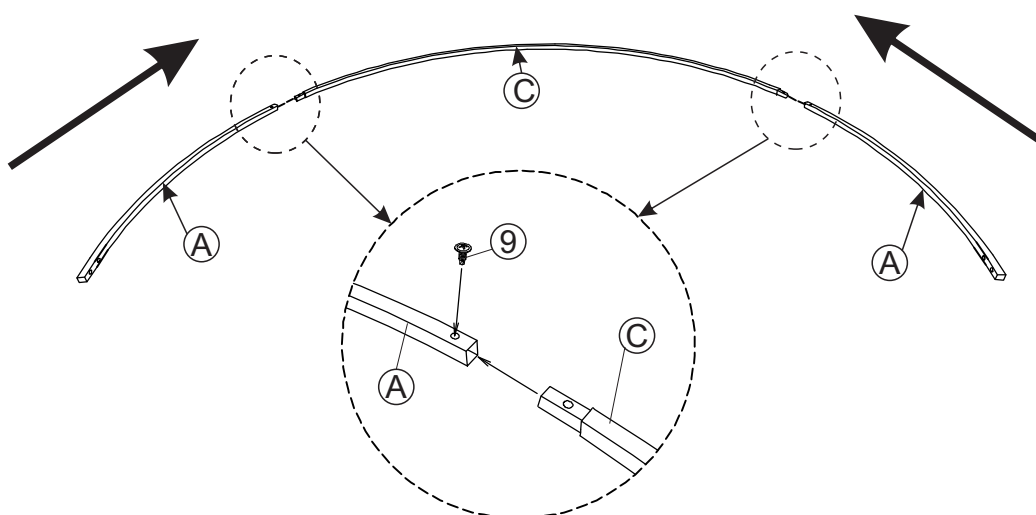

- A x6
- C x3
- 9 x6

**STEP 20**

**Part B**

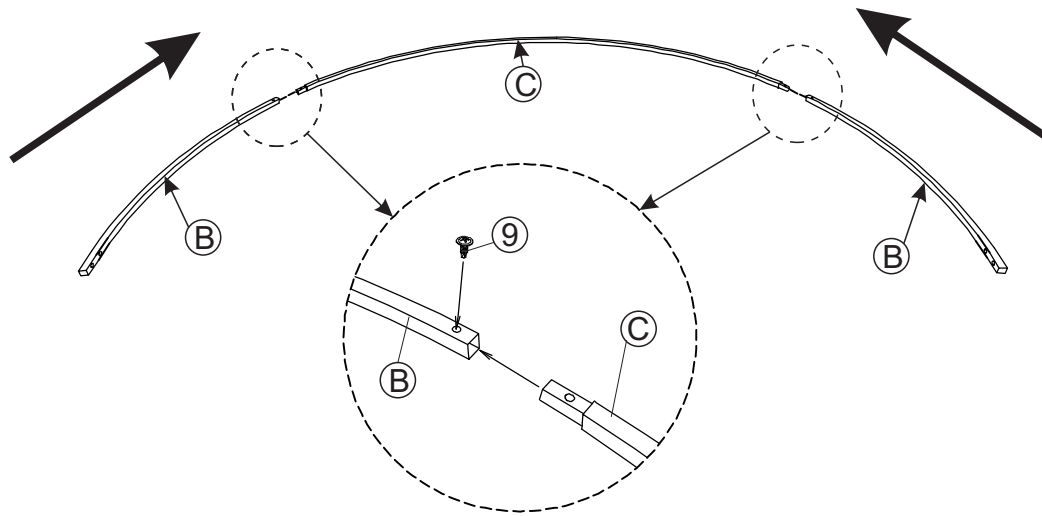

(B)x2 (C)x1 (9)x2

**STEP 21**

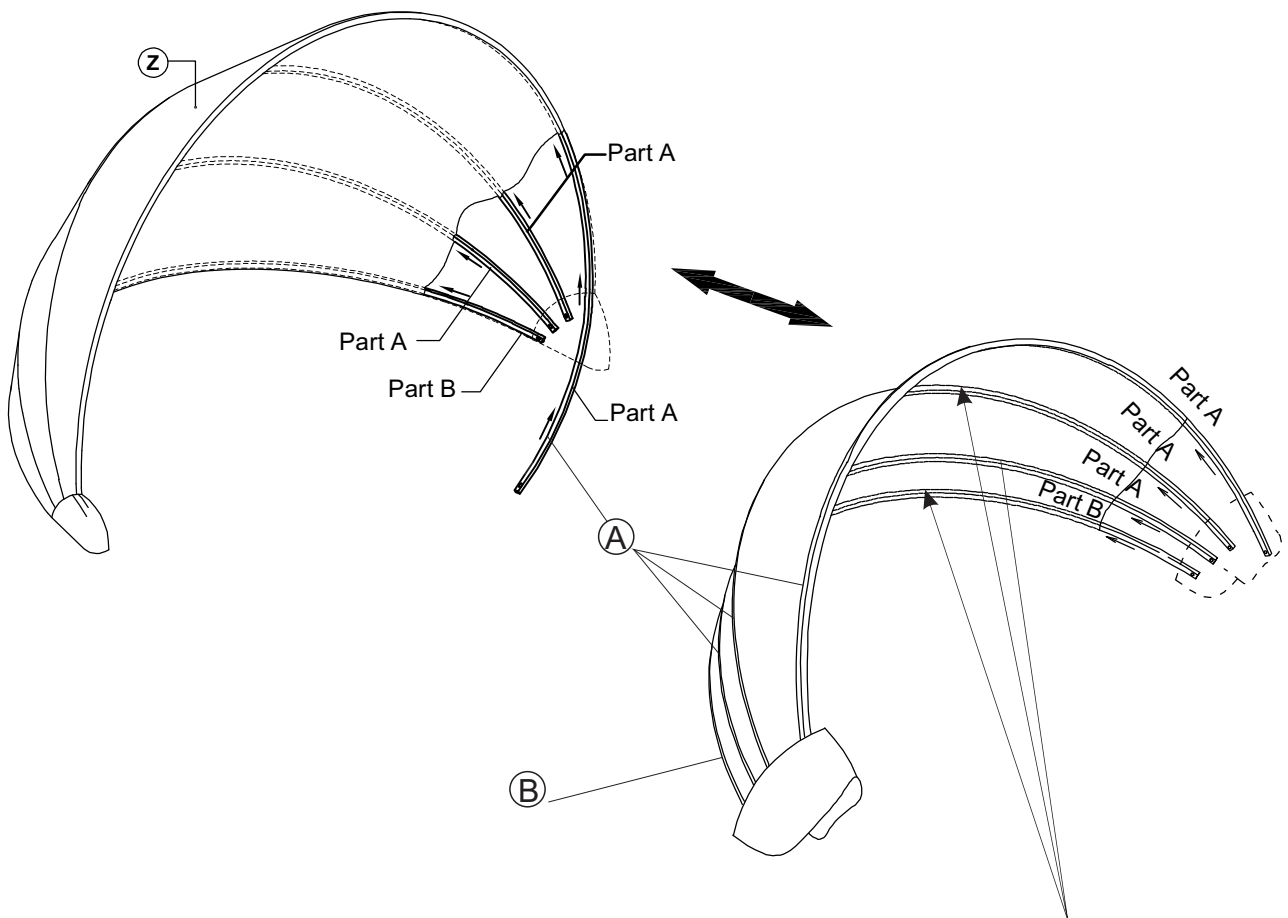

**The frame edge is invisible inside  
and visible outside the roof**

(Z)x1

# STEP 22

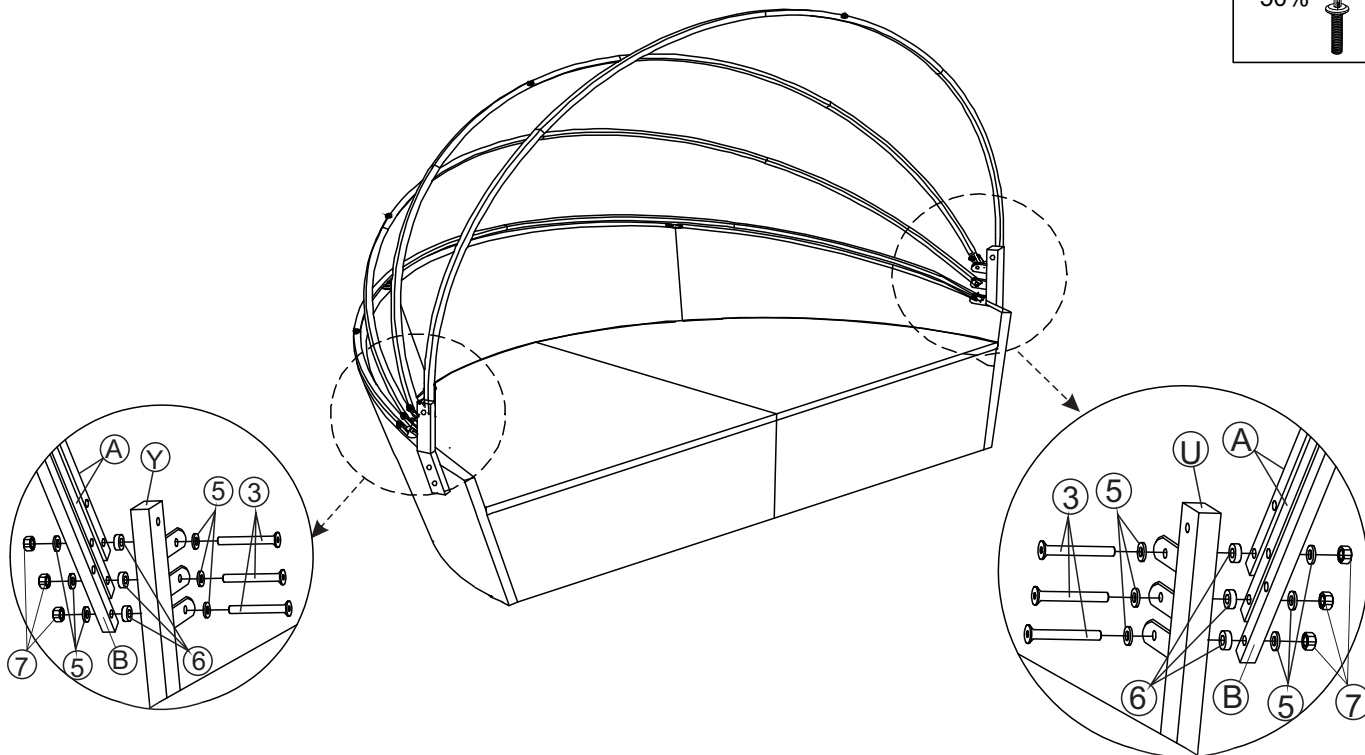
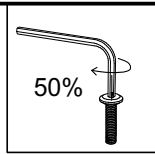

- ③ x6
- ⑤ x12
- ⑥ x6
- ⑦ x6

# STEP 23

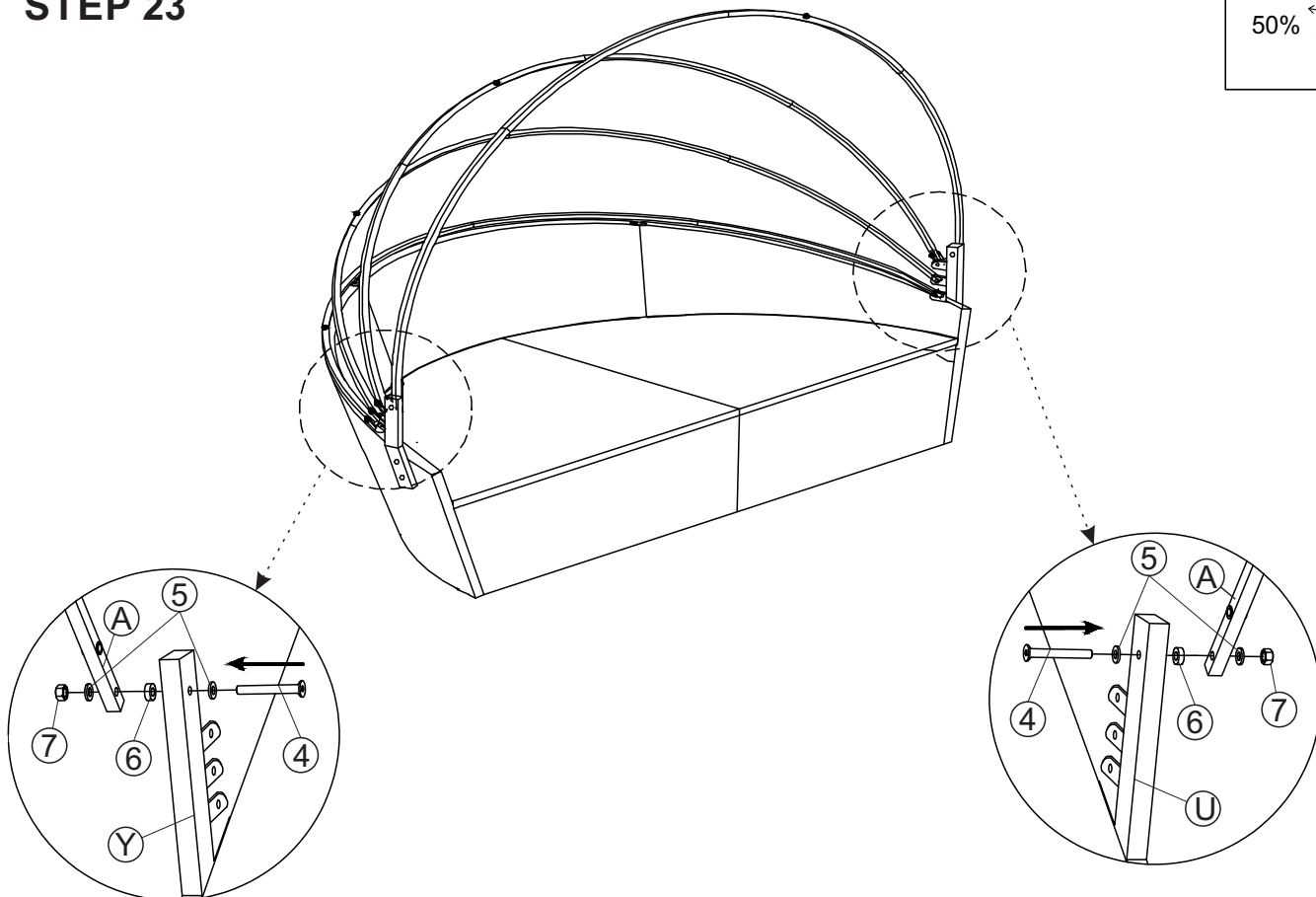
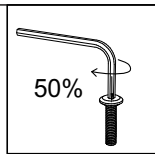

- ④ x2
- ⑤ x4
- ⑥ x2
- ⑦ x2

## STEP 24: Assemble the gaflifter

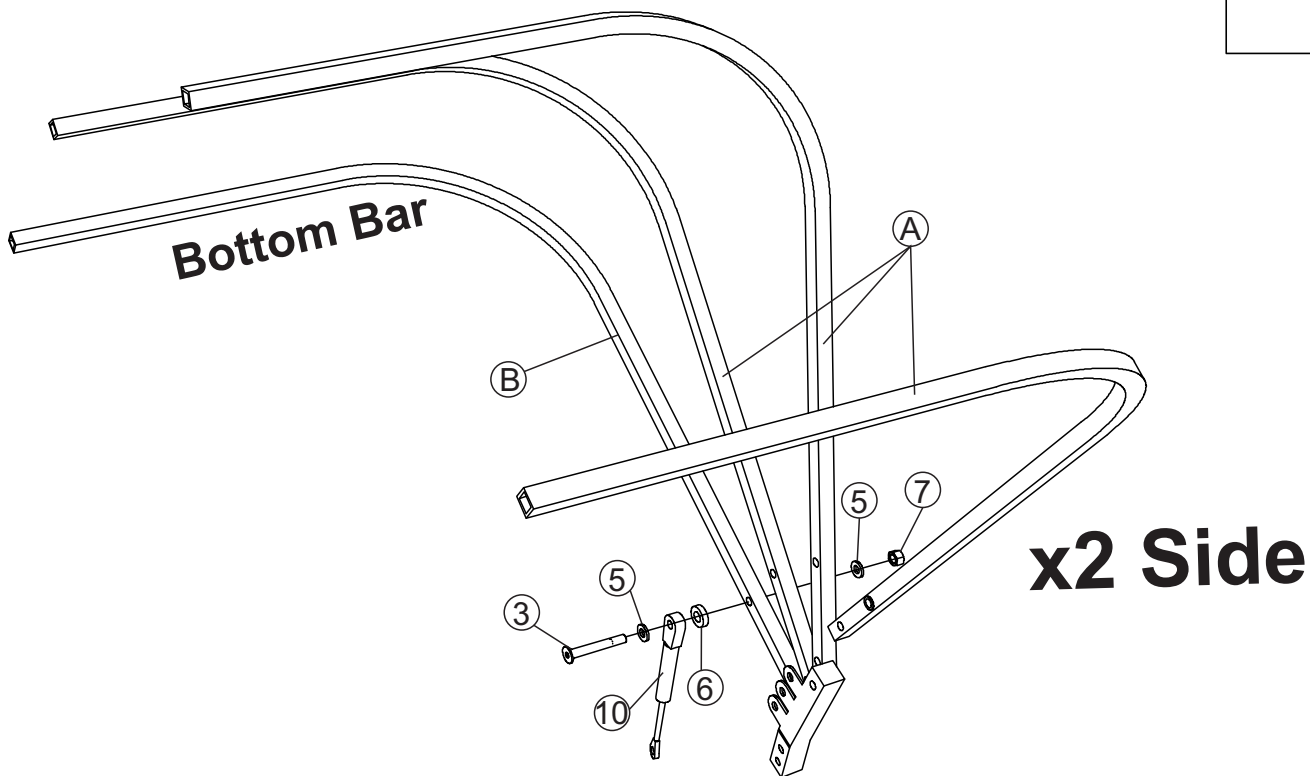
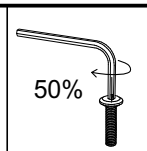

③ x2 | ⑤ x4 | ⑥ x2 | ⑦ x2 | ⑩ x2

## STEP 25: Assemble the air lifter

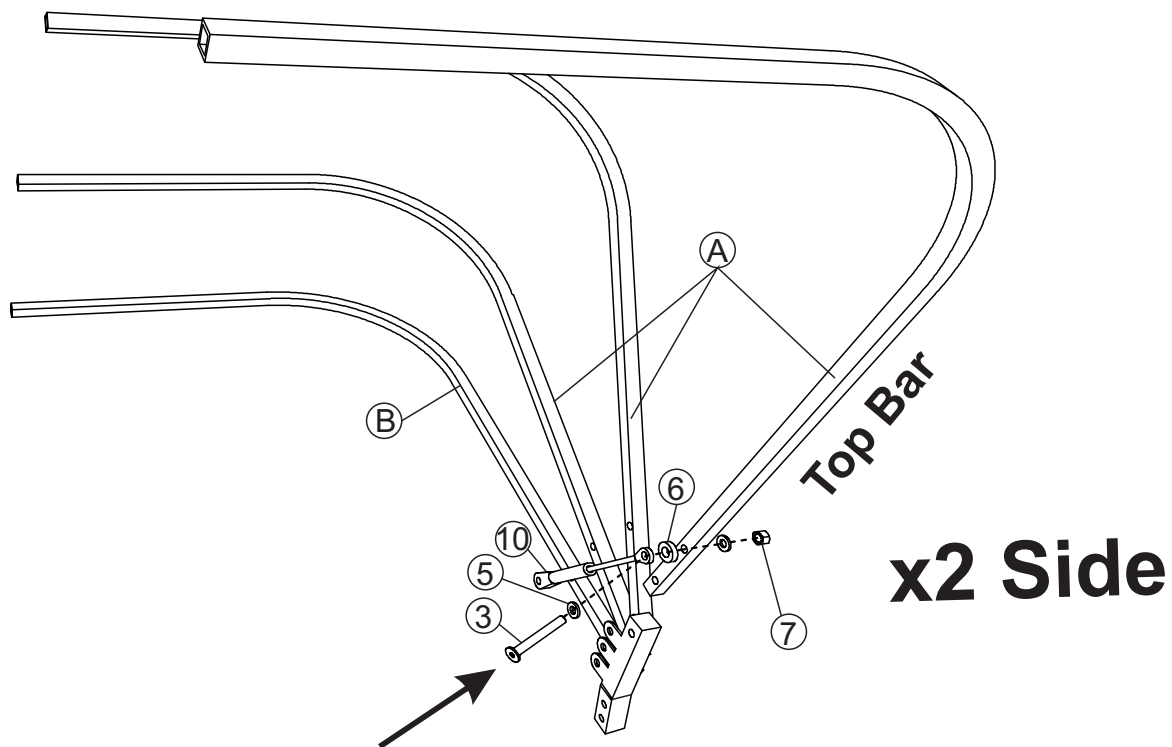
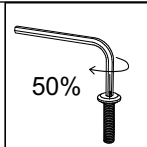

③ x2 | ⑤ x4 | ⑥ x2 | ⑦ x2

## STEP 26

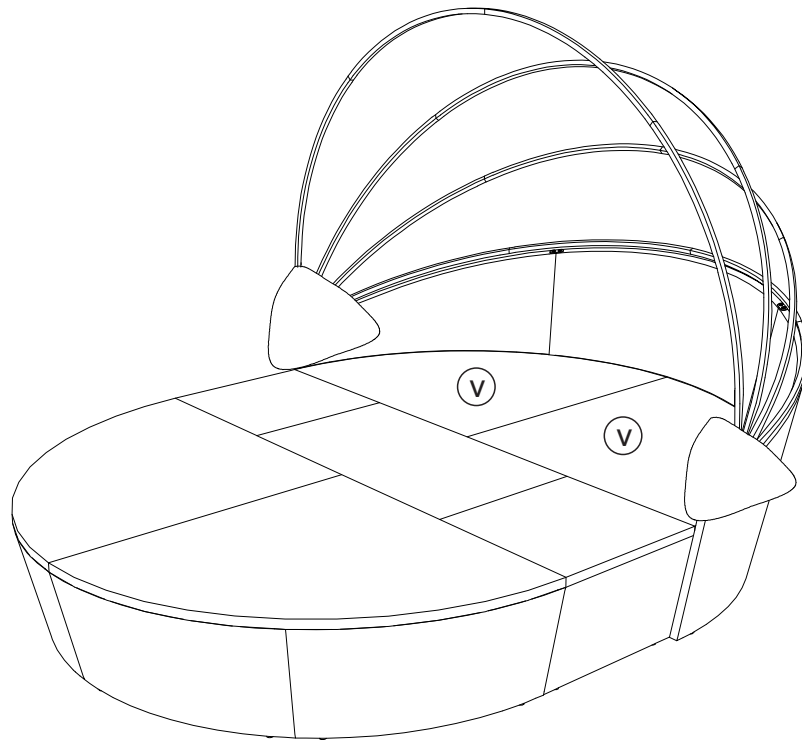

Vx2

## STEP 27

Connect details together by Connector plastic (12)

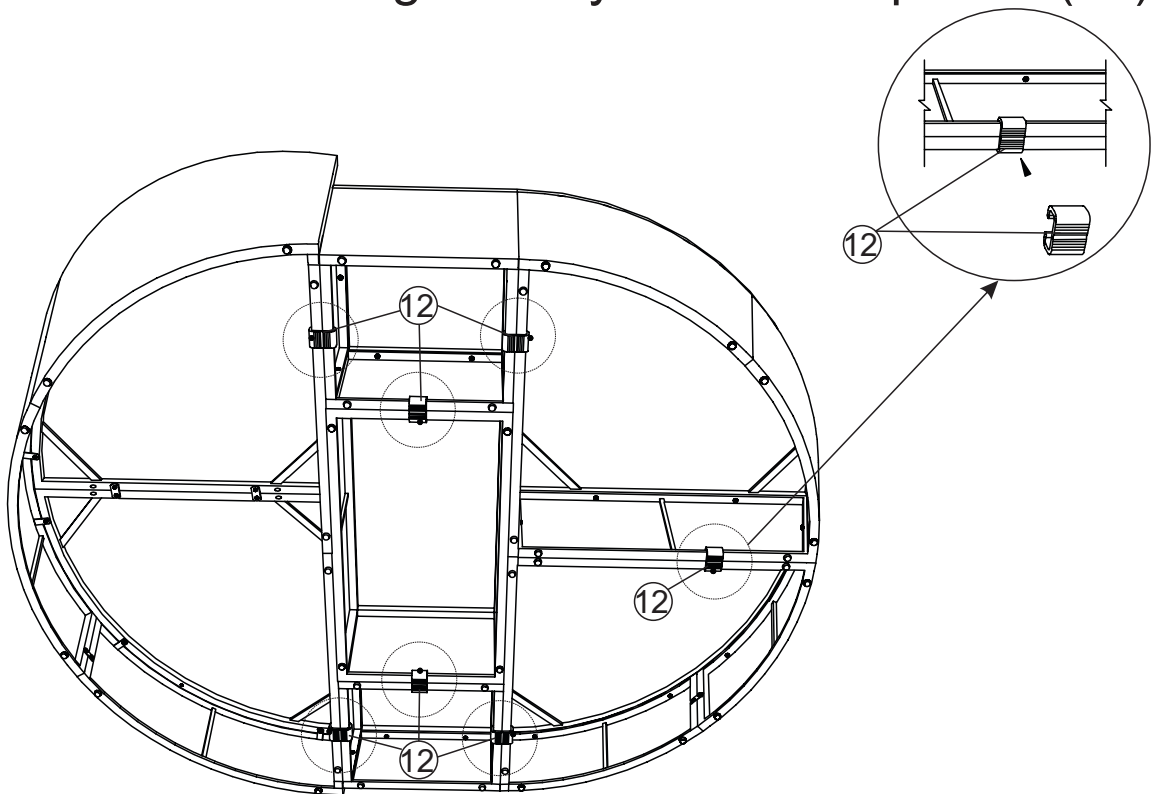

12x7

**STEP 28**

Put On Sunbed pillow (T) To Complete Sunbed.

