

ASSEMBLY INSTRUCTIONS

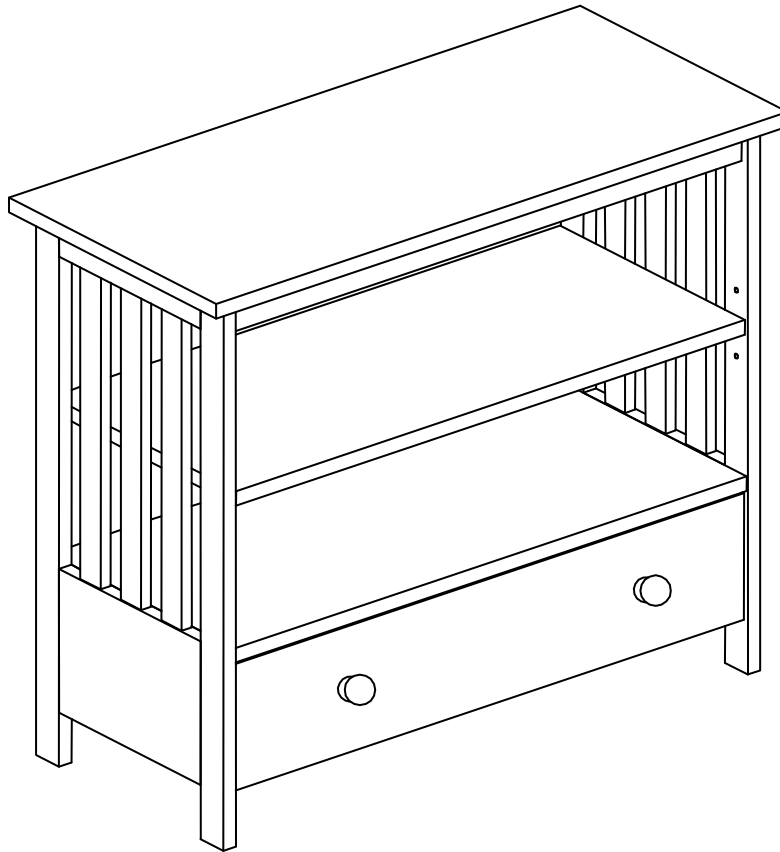

WARNING!

Serious or fatal injuries can occur from furniture tip over. Use tip over restraint (provided) to secure this product to the wall.

Description	: 36 IN MISSION TV STAND
Item No.	: TV-36

BEFORE ASSEMBLY

Thank you for purchasing this quality product. This product has been designed for easy assembly and constructed for durability. All parts were checked prior to packaging to insure quality. Prior to beginning assembly, however, make sure all parts and hardware are included and free of obvious defect. If a part is missing or defective, please contact the store where purchased. If hardware is missing, or you need help with assembly, please call toll free 888-944-8396.

IMPORTANT NOTE:

- Place all wooden parts on a clean and smooth surface such as a rug or carpet to avoid the parts from being scratched.
- Remove all wrapping material, including staples & packing straps before you start to assemble.
- DO NOT tighten all screws and bolts until completely assembled.
- Keep all hardware parts out of reach of children.

WARNING:







Long exposure to rubber or soft plastic may cause a chemical reaction and damage the finish of your product. Protect the surface of the product with cloth if you are using any product with rubber feet or base.

ASSEMBLY TOOLS REQUIRED NOT INCLUDED

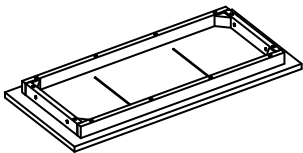
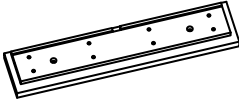
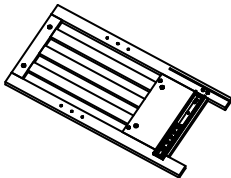

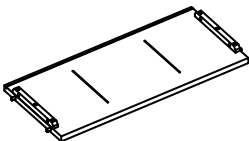
PART LIST

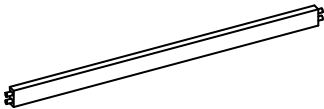
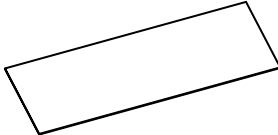
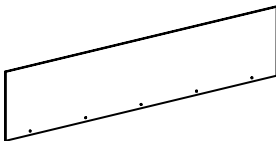
When unpacking, please be careful not to discard any parts with the packaging. Before continuing, please make sure you have the following parts:

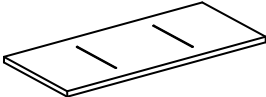
NO	Description	Qty	Sketch	NO	Description	Qty	Sketch
A	Top	1		G	Drawer Front	1	
B	Side Frame (L-R)	2		H	Drawer Side (L-R)	2	
C	Bottom Shelf	1		I	Drawer Back	1	
D	Support Rail	1		J	Drawer Bottom	1	
E	Back panel	1		K	Drawer Support Bar	1	
F	Shelf	1					

NOTE: WARNING LABEL (INCLUDED)

WARNING

Serious or fatal crushing injuries can occur from furniture tipover. To help prevent tip-over:

- Install tipover restraint provided.
- Place heaviest items in the lower drawers.
- Unless specifically designed to accommodate, do not set TVs or other heavy objects on top of this product.
- Never allow children to climb or hang on drawers, doors or shelves.
- Never open more than one drawer at a time.

Use of tipover restraints may only reduce, but not eliminate, the risk of tipover.

This is permanent label. Do not remove.









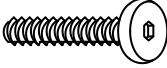
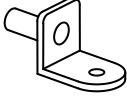

ITEM NO.: TV-36

REVISED APR 08, 2020

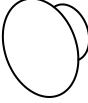
Printed in Vietnam

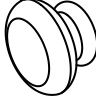
HARDWARE LIST

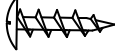
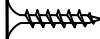
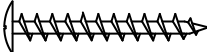
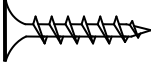
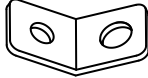
When unpacking, please be careful not to discard any parts with the packaging. Before continuing, please make sure you have all of the following hardware:

NO	Description	Qty	Sketch	NO	Description	Qty	Sketch
1	Bolt (M6 x 35mm)	8		9	Shelf Support Bracket	4	
2	Spring Washer (Φ6.5 x 11mm)	8		10	Medium Pan head screw *Metal knob: (M4x22mm) *Wooden knob: (M4x25mm)	2	
3	Flat Washer (Φ6.5 x 19mm)	8		11	Wooden Knob (Φ38 x 30mm)	2	
4	Allen Key (M4 x 30mm x 110mm)	1			METAL KNOB (Φ30 x 30mm) GOES WITH FINISHED ITEM ONLY.)	2	
5	Short Pan head screw (M3.5 x 15mm)	5		12	Short Pan head screw (M4 x 15mm)	2	
6	Short Screw (M3.5 x 15mm)	8		13	Long Pan head screw (M4 x 50mm)	2	
7	Long Screw (M4 x 35mm)	10		14	Steel Tip Bracket	4	
8	L-Bracket	2		15	Flat Nylon Tie	2	

STEP 1

Attach bottom panel (C) and top (A) to side frames (B) with bolts (1), and washers (2) and (3) as shown below. Tighten with Allen key (4).

Attach support rail (D) to side frames (B) with brackets (8) and screws (6) as shown below. Tighten with a screwdriver.

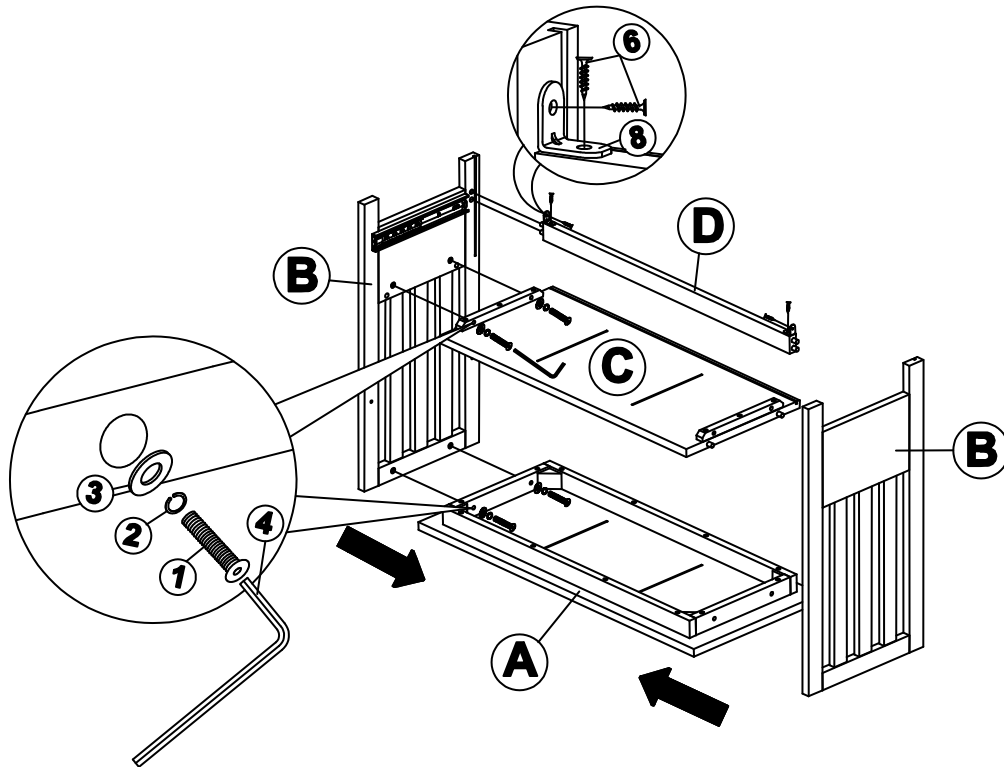

STEP 2

Slide back panel (E) into the grooves, then attach back panel (E) to the unit with screws (5) as shown below. Tighten with a screwdriver.

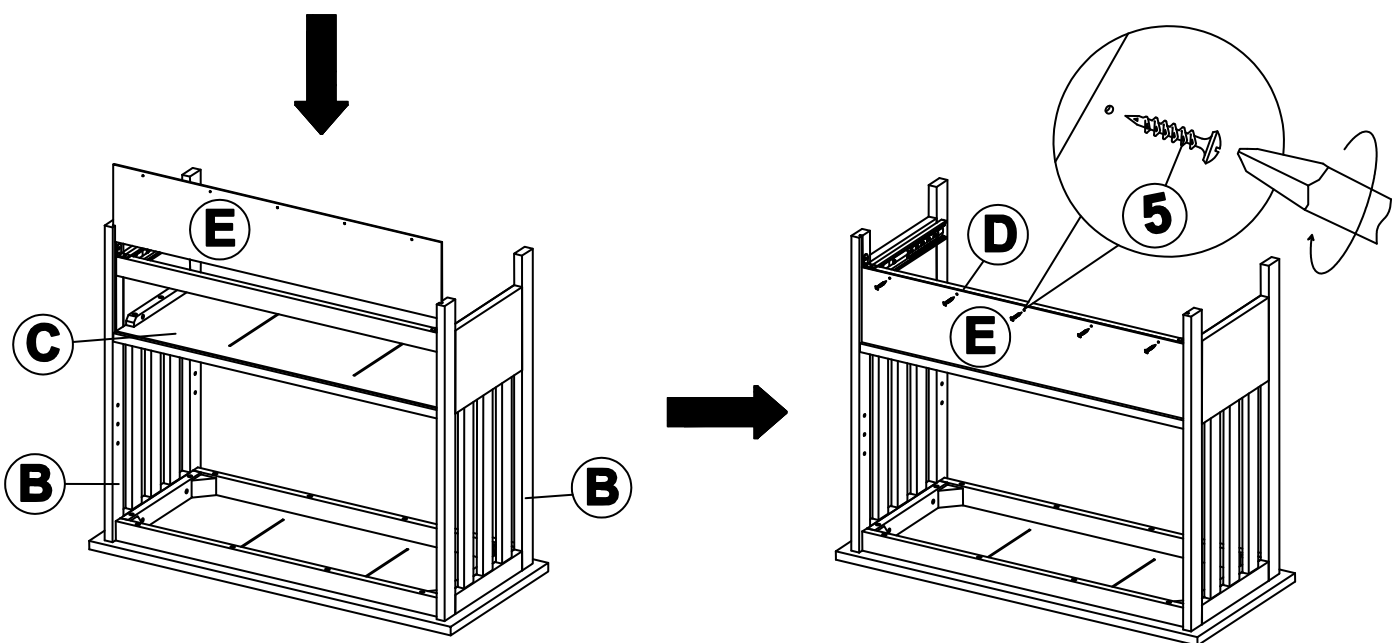

STEP 3

Attach drawer sides (H) to drawer front (G) with screws (7) as shown below. Tighten with a screwdriver. Slide drawer bottom (J) into grooves of drawer sides (H) and drawer front (G) as shown below. Attach the drawer back (I) to the drawer sides (H) with screws (7) as shown below. Tighten with a screwdriver. Attach support bar (K) to bottom of drawer with screws (7) as shown below. Tighten with a screwdriver.

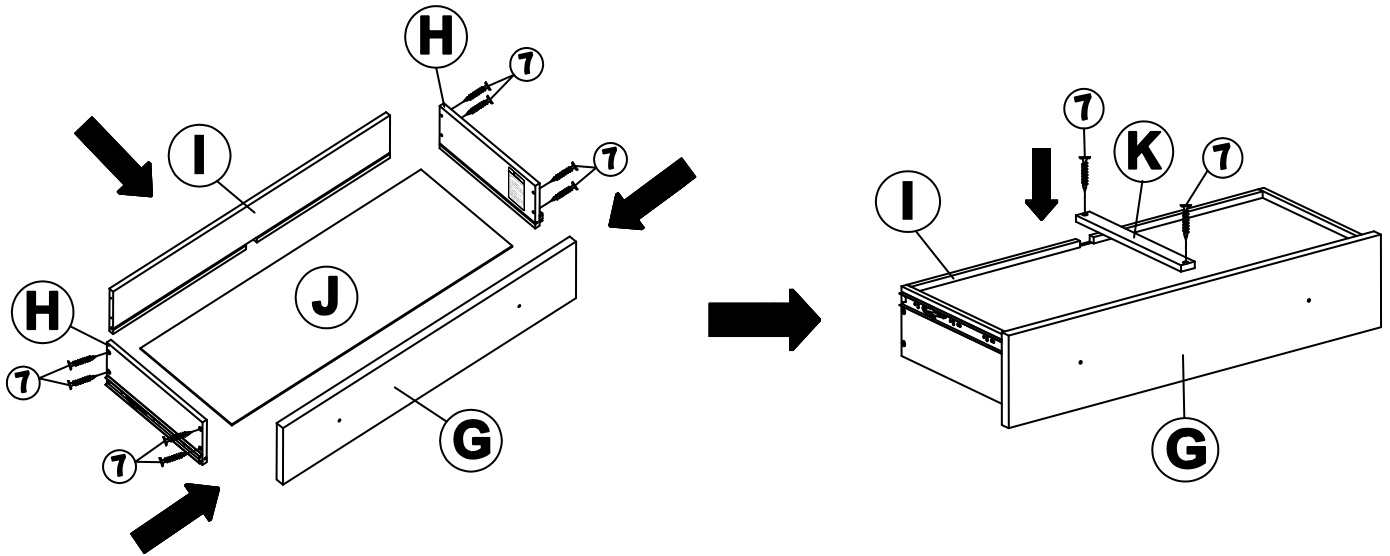

STEP 4

Carefully put the drawer into the unit. Insert brackets (9) into the unit as shown below. Place shelf (F) on the brackets and attach with screws (6). Tighten with a screwdriver. Attach knobs (11) to front of drawer with pan head screws (10) as shown below. Tighten with a screwdriver.

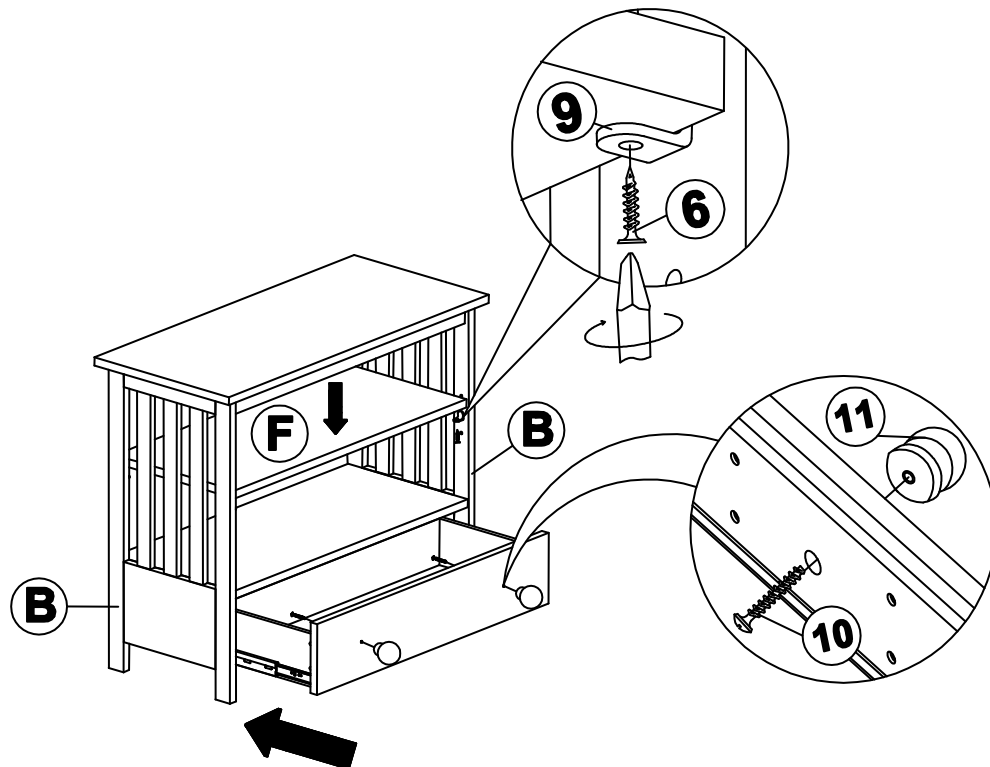

STEP 5

Attach brackets (14) to the back of the unit with screws (12) through the smaller holes in the brackets as shown below.

Important!

Properly attach the other brackets (14) to the wall in an area of **drywall or plaster with a wood stud**: Mark the attachment point(s) with a pencil at the appropriate height **positioned over the wood stud(s) in the wall**.

Place the unit into position so both mounting brackets are vertically in line.

Properly attach the other brackets (14) to the wall stud with screws (13) through the smaller holes as shown below.

Lace the end of flat nylon ties (15) through the larger holes in each mounting bracket. Bring both ends together and slide the flat ends through the locking ends and draw it through until all slack is removed.

Confirm that the strap is securely laced and locked.

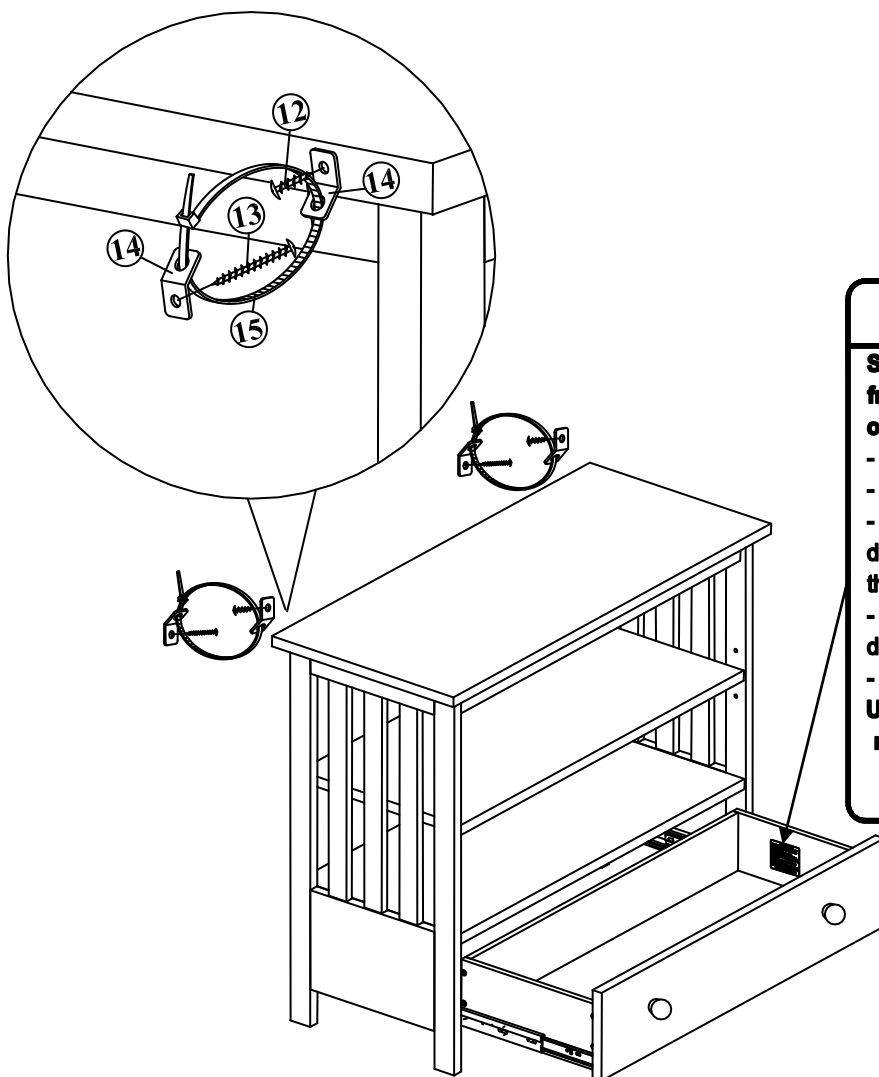

WARNING

Serious or fatal crushing injuries can occur from furniture tipover. To help prevent tipover:

- Install tipover restraint provided.
 - Place heaviest items in the lower drawers.
 - Unless specifically designed to accommodate, do not set TVs or other heavy objects on top of this product.
 - Never allow children to climb or hang on drawers, doors or shelves.
 - Never open more than one drawer at a time.
- Use of tipover restraints may only reduce, but not eliminate, the risk of tipover.**

This is permanent label. Do not remove.