

# WARRANTY

## USPA Personal Hygiene Appliance Limited Warranty

- We warrant our products to be free from manufacturing defects under normal use and service for a period of one (1) year from the date of your purchase.  
100% Coverage of all parts and labor for the entire product for the first year from original date of purchase.  
This warranty is only valid within the United States and Canada.
  - Our obligation to you under this warranty is limited to repair or replacement, at our option, of defective products or parts, provided that the products were properly installed and used in accordance with instructions. We reserve the right to make inspections in order to determine the cause of the defect. We will not charge for labor or parts in connection with warranty repairs or replacement. We are not responsible for the cost of removal, return and/or reinstallation of products.
  - This limited warranty does not apply to:
    - a) Damage or loss from a fire, earthquake, flood, storm, etc.
    - b) Damage or loss resulting from any unreasonable use, abuse, negligence, or improper maintenance.
    - c) Damage or loss from improper installation, removal, repair, or modification.
    - d) Damage or loss resulting from sediment or other matters contained in your water system.
  - This warranty gives you specific legal rights.
  - For warranty or service information, please contact your dealer where you bought this appliance or us.
  - Only the original purchaser may submit a claim under this limited warranty. To activate your warranty, complete this form.
  - This limited warranty is our only warranty covering your product. Repair or replacement as provided under this warranty shall be the exclusive remedy available to you. We shall not be responsible for loss of the product or for other incidental, or consequential damage or expenses you may incur or for labor or other costs due to installation or removal, or cost of repairs by others, or for any other expense not specifically stated above. Except to the extent prohibited by applicable law, any implied warranties, including that of merchantability or fitness for use, are expressly limited to the duration of this warranty.
- ※ Warning! We are not responsible or liable for any failure of, or damage to, this plumbing product or product component caused by in-tank bowl cleaners containing chlorine(calcium hypochlorite).
- ※ Note : The use of high concentration of chlorine related products can seriously damage the fittings. This damage can cause leakage and serious property damage.
- For more information, please contact your dealer or us.

Mail, email or fax the warranty form to :

**BBC INNOVATION**

7900 S RT 31 Crystal Lake IL 60014

TEL:847-458-2334 FAX:847-854-1296

E-mail : support@biobidet.com <http://www.biobidet.com>

**IS Dongseo Co Ltd**

Eunsung building, 741, Yeongdong-daero, Gangnam-gu, Seoul, Korea

TEL:82-2-3218-9341 FAX:82-2-3445-1686

E-mail:infor@isdongseo.co.kr <http://www.inushaus.com>

*Great products for your healthy living !*

If you need any help,  
Please call us.

**CUSTOMER CENTER**  
**877-339-5214**

**BBC INNOVATION**  
7900 S RT 31 Crystal Lake IL 60014



# Operating Instruction Manual

**A8**

- *Thank you for purchasing this USPA bidet seat.*
- *You are kindly requested to carefully read this operation manual for proper use of this appliance.*
- *Please save this manual and place it in an easily accessible location.*
- *Please register warranty for proper service.*

## READ ALL OPERATING INSTRUCTIONS BEFORE INSTALLATION.

### Notes

1. This product should be installed according to this manual.
2. Read this manual carefully and install properly.
3. Keep this instruction manual in an easily accessible place.
4. Do not attempt to service this appliance yourself. Doing so will void the warranty.

## Table of Contents

### PREPARATION

1. IMPORTANT SAFEGUARDS	1
2. CAUTIONS BEFORE INSTALLATION	2
3. IDENTIFICATION	3
4. SAFETY INFORMATION (DANGER)	4
5. SAFETY INFORMATION (WARNING)	5

### INSTALLATION

6. HOW TO INSTALL	6
-------------------	---

### HOW TO USE

7. HOW TO USE	8
8. HOW TO CLEAN	12
9. MAINTENANCE	13

### ETC

10. BEFORE CALLING FOR SERVICE	14
11. SPECIFICATIONS	14
12. WARRANTY	15

# 1. Important Safeguards

## 1. READ ALL INSTRUCTIONS BEFORE USING

### **DANGER - To reduce the risk of electric shock:**

1. Do not place or store this appliance in a location where it can fall or be pulled into a tub or sink.
2. Do not place in, or drop into water or other liquids.
3. Do not touch a product that has fallen into water. Unplug immediately.

### **WARNING - To reduce the risk of burns, electric shock, fire or injury.**

1. Close supervision is necessary when this appliance is used by or is near infants, elders, or with disability persons. Children should not be permitted to use or touch this appliance without adult supervision.  
Be sure to adjust the toilet seat's temperature for elders, with disability persons, or people with sensitive skin.
2. Use this appliance only for its intended purpose as described in this manual.  
Only use attachments recommended by the manufacturer.
3. Do not operate this appliance if the cord is damaged or if the product is dropped into water.
4. Install the unit properly by following the installation procedure.
5. Only authorized persons can install or repair the unit. Do not attempt to service this appliance by yourself.  
Doing so could void the warranty.
6. Keep the cord away from heated surfaces.
7. Never drop or insert any objects into any opening or hose.
8. Do not use outdoors. Do not use aerosol or oxygen spray products on the unit.
9. Always follow the grounding instructions in this manual before plugging in the unit.

## SAVE THESE INSTRUCTIONS

# 2. Cautions before installation

## 1. NOTE THE FOLLOWING IMPORTANT POINTS

1. Do not install in a location where water might be splashed on this appliance or in a location exposed to excessive moisture where condensation might form on the product's surface.
2. To avoid damage to electronic components due to high levels of humidity, provide adequate ventilation by opening a window and/or door when bathing.
3. Water supply should have a water pressure of 0.07 MPa to 0.74 MPa.
4. Connect the product to a pipe carrying potable water. Do not connect to an industrial water line or other water supplies that are not potable.
5. Bring the unit to room temperature.
6. The thermal protector in the water tank may malfunction when transporting or storing warm water.
7. The rated power voltage in AC 120V, 60Hz
8. Do not plug the unit in, until installation is complete. It may result in malfunction.

## 2. Cautions before installation

### 2. WIRING REQUIREMENTS

1. After installation all other servicing should be performed by authorized service representatives.

#### 2. GROUNDING INSTRUCTIONS

This product should be grounded. In the event of an electrical short circuit, grounding reduces the risk of electric shock by providing an escape wire for the electric current. This product is equipped with a cord having a grounding wire and grounding plug. They must be plugged into an outlet that is properly installed and grounded.

**DANGER-Improper use of the grounding plug can result in a risk of electric shock.**

If it is necessary to repair or replace the cord or plug, do not connect the grounding wire to a flat blade terminal. The grounding wire can be identified by its insulated outer surface. It will either be colored green or will not contain yellow stripes.

Check with a qualified electrician or serviceman if you do not understand grounding instructions or if you do not know whether the product is properly grounded.

3. This product is for use on a nominal 120V circuit. It has a grounding plug that similar to the plug illustrated in sketch A. A temporary adapter, which looks like the adapter illustrated in sketches B and C, may be used to connect this plug to a 2-pole receptacle as shown in sketch B if a properly grounded outlet is not available. The temporary adapter should be used only until the properly grounded outlet (sketch A) can be installed by a qualified electrician. The green colored rigid ear, lug and the like extending from the adapter must be connected to a permanent ground such as a properly grounded outlet box cover. Whenever the adapter is used, it must be held in place by the screw.

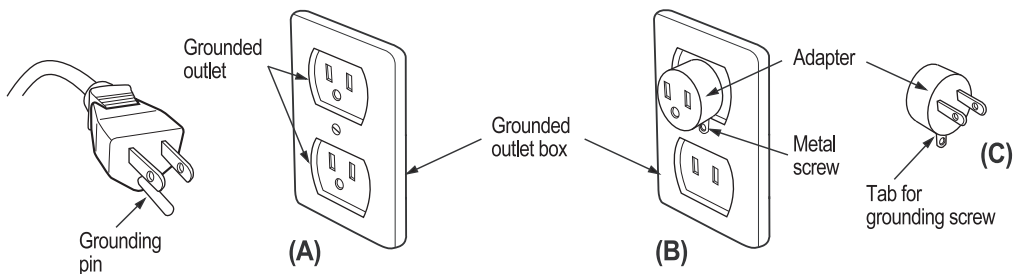

4. If it is necessary to use an extension cord, use only a three wire extension cord that has a three-blade grounding plug, and a three-slot receptacle that will accept the plug on the product. Do not use a damaged extension cord.

5. Remote control power : AAA(1.5V), 3EA

#### ※ CAUTION

**RISK OF EXPLOSION TO BATTERY IF REPLACED BY AN INCORRECT TYPE.  
DISPOSE OF USED BATTERIES ACCORDING TO THE INSTRUCTIONS.**

# 3. Identification

## Main unit

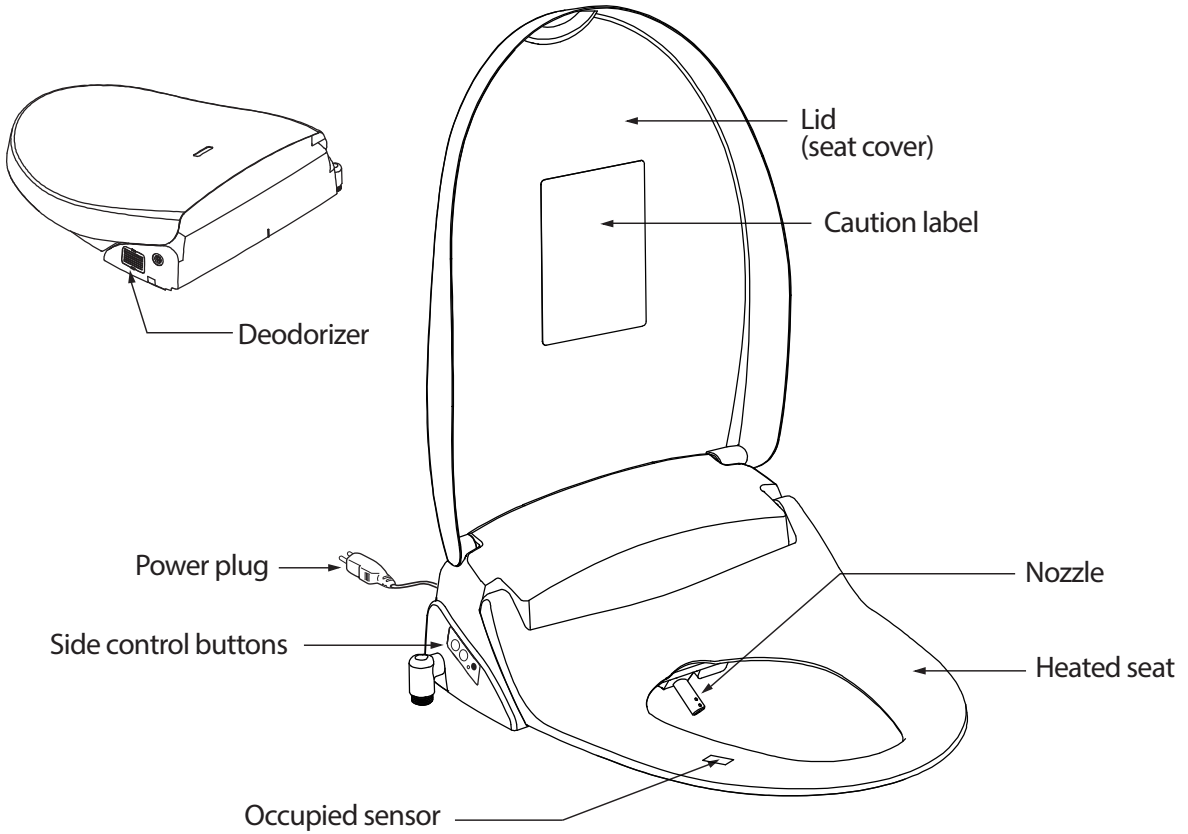

## Accessories

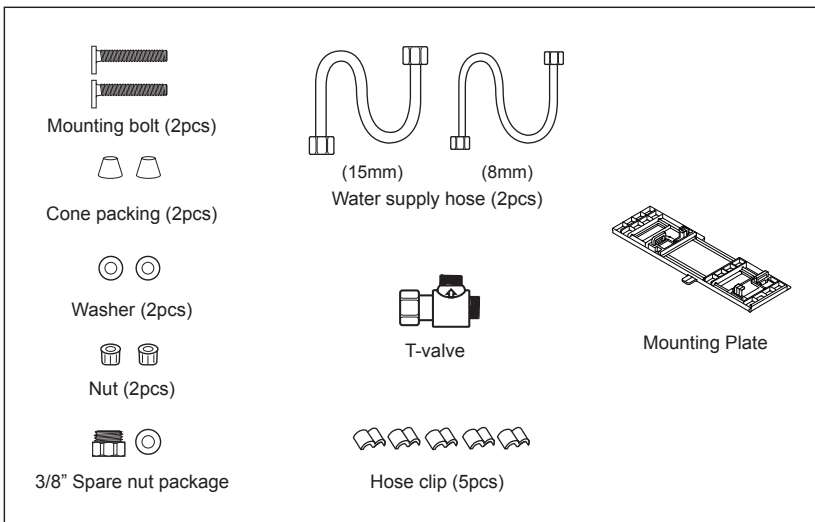

## Remote Control

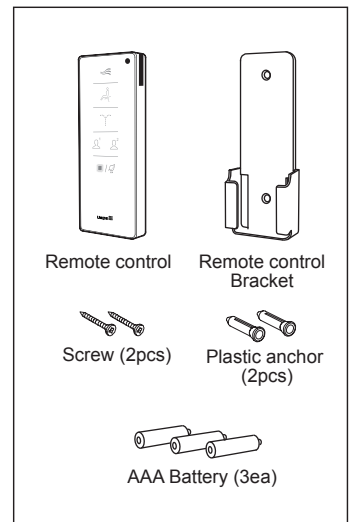

※ In the interest of continued product improvement, specifications may change without notice.











## 4. Safety Information (Danger)

Follow basic instructions to ensure the safe use of your appliance.

### **DANGER**

Failure to follow may cause severe injury or death. Follow the instructions.

 Indicates a [prohibited] use of the appliance.	 Prohibited  Do not disassemble  Use of fire prohibited  Do not handle with wet hands
 Indicates a [required] step in use of this appliance.	 Required step  Ground Connection

-  Do not splash water or cleansers on the product's plug. Doing so may result in fire or electric shock.
-  Do not plug or unplug with wet hands.  
-It may result in injury or electric shock.  
-Regularly wipe off the plug and electric outlet with a dry, soft cloth to prevent electric shock or fire.
-  Do not use a faulty or loose electric outlet or cord.  
-Doing so may result in short circuit, electric shock or fire.
-  Do not throw anything flammable into the toilet.  
-Doing so may result in fire, discoloration or malfunction.
-  Grounded wire or outlet must be installed.  
-Not doing so may result in malfunction or electric shock.  
-If no grounded plug is used, make sure to install grounded wire.
-  Do not use many appliances in one power strip.  
-Doing so may result in fire or damage.  
-Be sure to use a dry and clean outlet.  
-Do not use a faulty or loose outlet.
-  Use potable water only. (ground water)  
-Not doing so may cause irritation or injury to your skin.  
-It may clog the pipe due to contaminants.
-  Do not disassemble the seat.  
-Doing so may result in electric shock.
-  Do not disassemble, repair or modify this appliance.  
-Doing so may result in electric shock, injury or malfunction.
-  Do not obstruct the warm air dryer outlet.  
-If the outlet is obstructed with any objects, it may result in fire.  
-If the outlet is obstructed with fingers or with hands, it may result in injury.
-  Unplug when you hear beeping or smell strange odor.  
-Unplug right away and contact your dealer from whom you bought this appliance.













## 5. Safety Information (Warning)

Follow basic instructions to ensure the safe use of your appliance.

### **WARNING**

Might cause slight injury or damage. Be aware.

 Indicates a [prohibited] use of the appliance.	 Prohibited  Do not disassemble  Use of fire prohibited  Do not handle with wet hands
 Indicates a [required] step in use of this appliance.	 Required step  Ground Connection

-  Be aware of a low-grade burn.
  - It may result in a low-grade burn if sitting on the heated seat for a long time.
  - Be aware if being used by the following: children, senior citizens, patients, people who cannot control the temperature, people who are not sober, or people who are tired.
  - If injured in a low-grade burn, see a doctor immediately.
-  Do not step on or place heavy objects on this appliance.
  - Doing so may damage the unit.
  - Do not step on a lid, seat, or control panel to avoid injury or product damage.
-  Unplug while not using over extended period of time.
-  Unplug when there is thunder or lightening.
-  Use this appliance on a toilet only.
  - Not doing so may result in fire, injury or electric shock.
-  Do not use force to pull out the water hose.
  - Doing so may cause water leakage.
-  Be aware of urine splash on a nozzle or warm air dryer outlet.
  - Not doing so may result in malodor or failure.
-  Do not use force to close the lid.
  - Doing so may cause malfunction.
  - Be aware not to put fingers between the lid and seat when you close the toilet. It may cause injury.
-  Unplug when cleaning.
  - Not doing so may result in fire or electric shock.
-  Use low temperature for children and handicapped.
  - If the temperature is too high, it may result in burn if they fail to recognize the temperature.
-  Do not sit or lean against the lid or the control panel.
  - Doing so may cause malfunction or breakage.
  - Applying excessive force may damage the lid or components that may lead to injury.
-  Do not put a vase cup or small materials on this appliance.
  - Doing so may result in fire or electric shock.



## 6. How to install

※ **If electric work is needed, please contact a qualified electrician or serviceman only.**

### Remove the existing toilet lid and seat

1. Remove the nuts, washers, and cone packings from the toilet seat and mounting bolts in the back of the toilet.
2. Remove the toilet seat, lid and mounting bolts.
3. Keep them in case you need them.

### Install the appliance

#### Installation

##### How to mount the plate

- 1 Place the mounting plate over each mounting hole. Insert the mounting bolts through the plate and mounting holes. Slide cone packings and washers onto the bolts and fasten tightly with nuts.

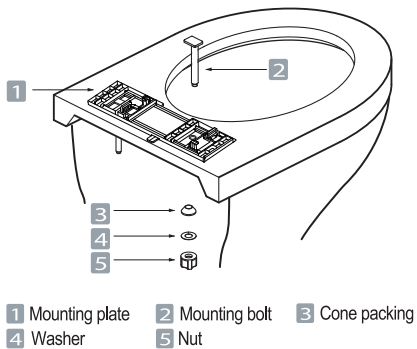

#### Toilet size (Elongated)

- 1 The toilet dimensions must be within those shown below. Do not install this appliance on a toilet that does not meet these dimensional requirements.

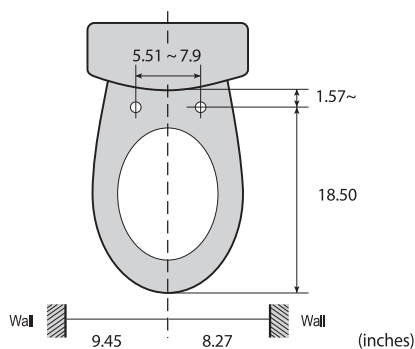

##### How to attach and detach the unit

- 1 Slide the unit until it clicks into the plate.

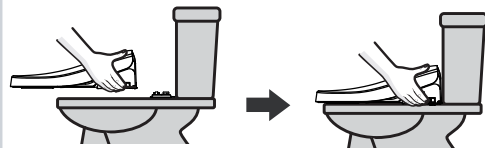

- 2 While pressing the detach button, pull the unit forward and separate it from the toilet bowl.

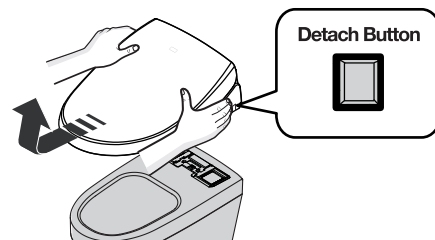

#### Occupied sensor

- 1 This appliance is equipped with an occupied sensor.
- 2 The unit will not work unless the seat is occupied.

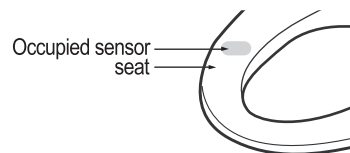

## Connecting the water hose

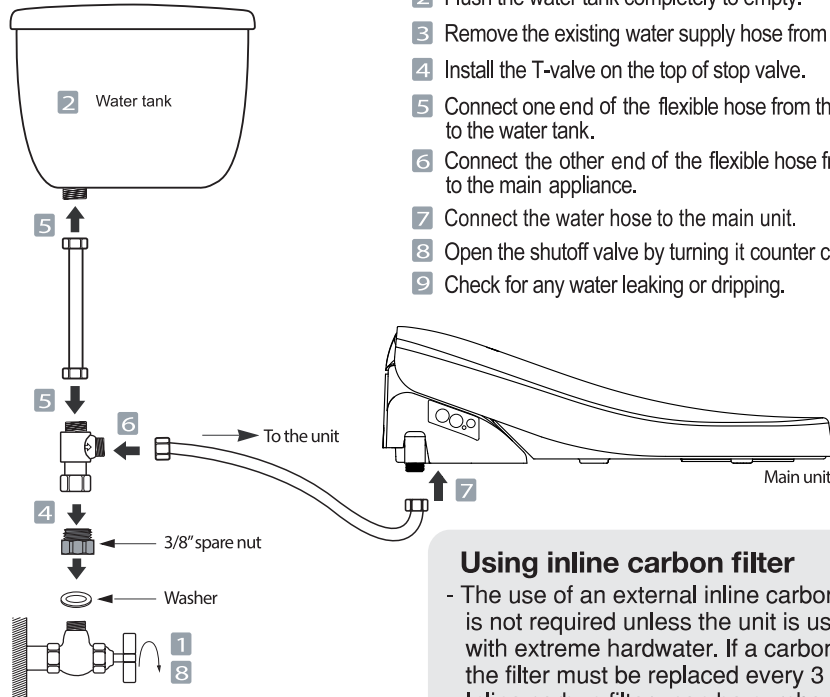

- 1 Close the shutoff valve by turning it clockwise.
- 2 Flush the water tank completely to empty.
- 3 Remove the existing water supply hose from the tank.
- 4 Install the T-valve on the top of stop valve.
- 5 Connect one end of the flexible hose from the T-valve to the water tank.
- 6 Connect the other end of the flexible hose from the T-valve to the main appliance.
- 7 Connect the water hose to the main unit.
- 8 Open the shutoff valve by turning it counter clockwise.
- 9 Check for any water leaking or dripping.

### Using inline carbon filter

- The use of an external inline carbon water filter is not required unless the unit is used in an area with extreme hardwater. If a carbon filter is used, the filter must be replaced every 3 months. Inline carbon filters can be purchased from any authorized Bio Bidet reseller.

※ Shutoff valve sizes may vary. If supplied parts do not fit, please call 877-339-5214.

*If a filter is used, it must be replaced every 3 months.*

*This product is designed and intended for use exclusively with BioBidet USPA water filters. The purchase or use of any other water filter is not the responsibility of BBC Innovation. As such, any use of non USPA water filters is prohibited and will void the warranty for those BioBidet products. BioBidet will not be responsible for any resulting damages or claims related to the misuse or distribution of non BioBidet USPA filters.*

## Trial operation

### 1. Preparation

Plug the power cord into the outlet, and then the water tank will be filled with water in 2 minutes.

### 2. Checking all functions

Cover the toilet bowl using the sheet of plastic wrap on the unit to prevent the washing water from being sprayed out of the toilet.

Then check for all function described in this manual.

### 3. There are possibilities of water coming out that remains in the unit while heating.

## 7. How to use



### Dry

- Press "Dry" Warm air will come out for 3 minutes.
- To alter the strength of drying, press the button again.
- Dry temperature can be adjusted by pressing LOW or HIGH button to 5 levels.



### Cleansing

- Press "Cleansing" to clean your posterior. The function will stop in 2 minutes automatically.
- Press this button again to activate oscillation. The nozzle moves back and forth automatically to widen cleansing area.
- Oscillation wash stops if this button is pressed again.



### Bidet

- Press "Bidet" for feminine wash. The function will stop in 2 minutes automatically.
- Press this button again to activate rhythmical wash for massage effect.
- Massage wash stops if this button is pressed again.



### User Setting ※ see page 11.



### Stop

- Press "Stop" to stop current operation.
- When a user stands up, all operation will stop automatically. (Except for Kids function)





### Eco

- Press "Eco" for 2 seconds to activate the power saving mode. Seat and water temperatures will set to low but temperature will keep remain at room temp.



### Temperature Adjustment (water / seat)



- Temperature of seat and water can be adjusted by pressing  or  button.
- There are four levels, Room temp - Low - Medium - High.



### Battery Alarm

- Change the batteries if the battery icon on LCD is flickering (LED on the front also flickers)

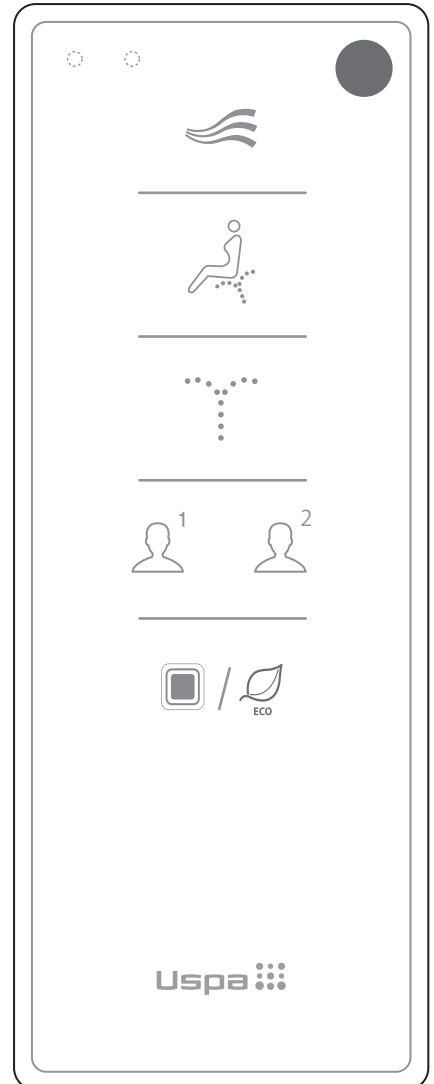

[Front]

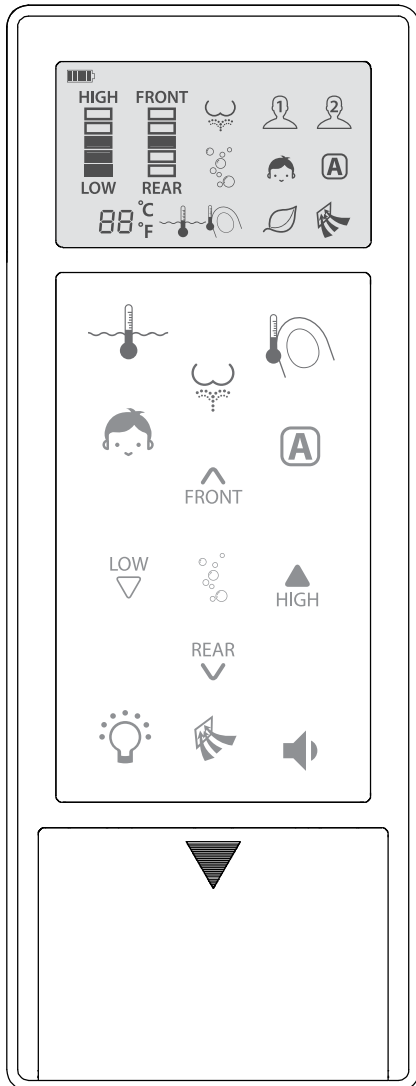

[Rear]



## Massage

- Press "massage" to activate rhythmical wash for massage effect when you are using "cleansing" or "bidet".
- Press the button again to release this function.



## Kids

- Press "Kids" to change all functions to be suitable for children. It will automatically operate from cleansing(2 min) to dry(3 min) with adequate water pressure and nozzle position.
- This unit should be used under the supervision of an adult.



## Auto

- Press "Auto" during the operation of "Cleansing", Cleansing wash (20 sec.) - Oscillating wash(20 sec.) - Massage(80 sec.) - Dry(3 min.) will operate.



## Nozzle Position

- Nozzle position can be adjusted by pressing FRONT or REAR button to 5 levels.
- Nozzle position will remain.



## Water Pressure (Cleansing / Bidet)

- Water spray pressure can be adjusted by pressing LOW or HIGH button to 5 levels.
- Water pressure level will remain.



## Aerated Spray

- This gentle but strong spray cleanses better while using "Cleansing", "Bidet" or "Kids".
- Aerated spray is released if this button is pressed again.



## LED

- Press the button to activate light on/off. Delicate light will help user to use toilet without turning the light on during night time.



## Deodorization

- When the appliance is in use, the deodorizer will work maximum 20 minutes automatically.
- When a user stands up, the function stops after 1 minute.



## Sound

- Press the button to enable the beeping sound.
- To disable, press the button again.



## IDENTIFICATION

- This function is useful for public toilets when more than one unit of this product is installed.
- To prevent interference among units, main unit and remote control should be set with the same ID.
- If there is only one unit in the bathroom, you do not need to set ID.
- Initial ID of remote control and main unit are "0". There are 16 choices in ID(00~15).



## HOW TO SET ID

### [REMOTE CONTROL]

- Press "High"() button for 3 seconds and ID shows up in display.
- Press "High"() or "Low"() button until your ID appears in display. (00~15)
- Press "Stop" to save the ID.

## SET THE UNIT

- Unplug the unit and then plug it back in.
- Push the power bidet button on the side of the unit to turn the unit off.
- Push the button again and this time hold it down(It should turn on when you do this)
- While holding that button down push the stop button on the remote for 2 seconds.

### NOTE

- If ID's of the remote control and the main unit are different, the main unit will not work.
- Make sure the remote control and the main unit are set with the same ID.
- ID will remain even the power is unplugged or the batteries of the remote control are replaced.

## SIDE CONTROL BUTTONS

- Use side control buttons on unit when remote control is broken or its batteries are dead.
- Press “Cleansing” or “Bidet” to start.
- Press again to stop. Do not use sharp items to press buttons.

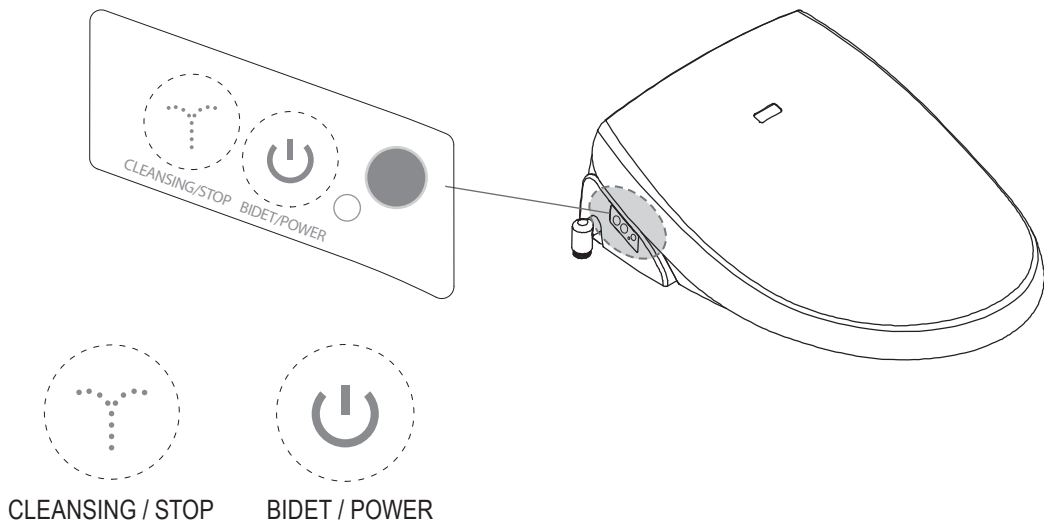

## USER SETTING

- Each button can save 2 setting.(Cleansing, Bidet)
- Press User 1 button and Cleansing or Bidet consecutively. Then Choose nozzle position by pressing FRONT / REAR button and water pressure level by pressing LOW / HIGH button.  
Press User 1 again will save the setting with beep.
- (※The same applies to saving User 2 setting.)

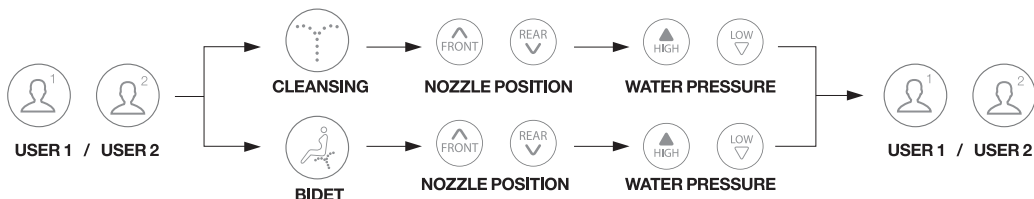

- Press User 1 or User 2 While using Cleansing or Bidet will operate saved settings.

# 8. How to clean

## Nozzle cleaning



Do not forcefully push or pull the nozzles, or bend them. It may result in failure. Make sure to use "Stop" button on the remote control.

### MANUAL CLEANING

- 1 Make sure the occupied sensor is not activated.  
(Do not sit on the seat or place hands on the seat sensor)
- 2 Press Front (FRONT) button for 2 seconds to extract the nozzle.
- 3 Use a tooth brush or soft cloth to clean the nozzle.
- 4 Press Stop button to retract the nozzle.



### AUTO CLEANING

- 1 Press Rear (REAR) button for 2 seconds to start auto cleaning.  
The nozzle will be cleaned for 30 seconds and returned automatically.
- 2 Press Stop button while cleaning will retract the nozzle.

※ Do not use force to push or pull the nozzles while cleaning.

## Strainer maintenance

This appliance will not operate properly if the strainer is clogged. Be sure to clean the strainer regularly.

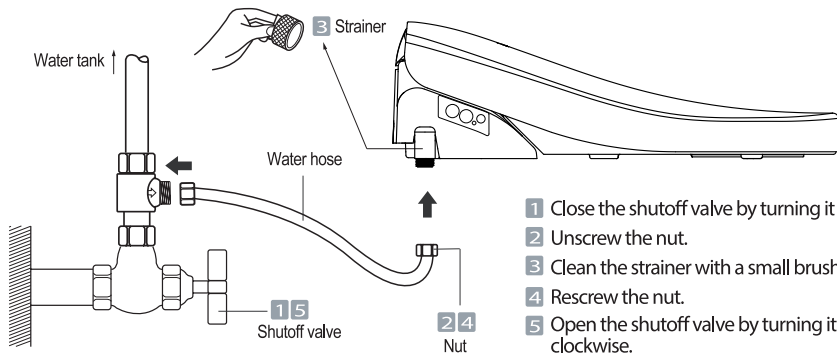

- 1 Close the shutoff valve by turning it clockwise.
- 2 Unscrew the nut.
- 3 Clean the strainer with a small brush.
- 4 Rescrew the nut.
- 5 Open the shutoff valve by turning it counter clockwise.

## Cleaning the body

- 1 Regularly wipe off the body with a dry soft cloth or sponge, or wash with a damp cloth and mild detergent.
- 2 For care of plastic body, do not use any cleansers such as : toilet cleanser, home cleanser, bleach, benzene, paint thinner, cresol etc



Toilet cleanser



Thinner Benzene



Bugs killer



Sand paper

# 9. Maintenance

## Draining water - while not using over extended period of time.

- 1** Unplug the power supply cord.  
- Not doing so may cause fire.

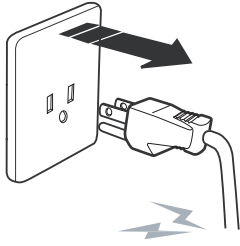

- 2** Close the shutoff valve.

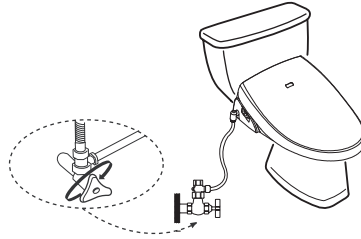

- 3** While pressing the detach button, pull the unit forward and separate it from the toilet bowl.



- 4** Uphold the appliance and thoroughly drain the water by unscrewing the drain bolt.  
(Beware of losing the drain bolt)

※ The following figure is only to check the location of 'Drain Bolt'. To prevent malfunction, do not place the vertical position or tilt the product.

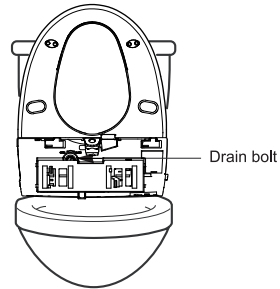

- 5** Screw the drain bolt and install the appliance.  
- Refer to the trial operation method in order to use this appliance again.

## Preventing freezing

- 1** Make sure the power cord is plugged in properly.

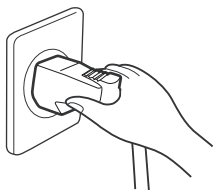

- 2** Set the temperature of water to low or middle.  
(Freezing can be prevented by thermal efficiency of water tank.)

■ If there is no heating system in the toilet, wrap pipes with cloth or other materials.

- 3** Not using the unit for a long time in winter unplug and drain the water from the water tank and pipes thoroughly.

■ Refer to the water drain method.



## 10. Before calling for service

Problem	Possible cause	Solution
Completely fails to work	Is there a power cord outage? Is the power cord unplugged? Are you sitting on the seat correctly?	- Check for power cord failure or a tripped breaker - Plug the power cord in properly - Sit on the seat completely
Water does not spray	Is the water shutoff valve closed? Is the strainer clogged? Are the nozzles clogged? Is the water purifying filter clogged?	- Check for any water leaking or dripping - Clean the strainer - Clean the nozzles - Change the water purifying filter
Water is leaking or dripping	Are all hoses tightened up properly?	- If water is still leaking or dripping, contact to your dealer
Seat, Water or air is not warm enough	Is the temperature set to OFF? Is appliance used in eco mode during cold weather?	- Reset the temperature - Press "eco" again to release the function

## 11. Specifications

Item	A8	
Standard power supply	AC 120V 60Hz 1248W	
Water supply	Way of connection	Direct connection to tap water
	Water pressure	0.07MPa ~ 0.74MPa
Clean-sing	Spray for cleansing	700 (±150)ml/min
	Spray for bidet	700 (±150)ml/min
	Water capacity	740ml
	Spray temperature	Room temp ~ 39°C (102°F)
Dry	Heater capacity	1200W
	Safety feature	Thermal switch, Temperature fuse, Floating switch
	Air temperature	Room temp ~ 60°C (140°F)
Heated seat	Heater capacity	250W
	Safety feature	Temperature fuse, Bimetal
	Seat temperature	Room temp ~ 39°C (102°F)
Deodorization method	Heater capacity	48W
	Safety feature	Temperature fuse
Circuit breaker	Catalytic filter	
Length of power cord	Within 15mA 0.03 second	
Dimensions	1.2m	
Weight	(W)410 mm(16.14 inches) X (L)528 mm(20.79 inches) X (H) 160 mm(6.30 inches)	
	4.0Kg(8.8lbs)	

※ Recommended water supply pressure are 0.1 ~ 0.69MPa.

※ The minimum available water supply pressure is 0.07MPa, however 0.1MPa pressure, water spray pressure might not be adequate.

# MEMO