

THIS INSTRUCTION BOOKLET CONTAINS  
**IMPORTANT** SAFETY INFORMATION. PLEASE  
READ AND KEEP FOR FUTURE REFERENCE.

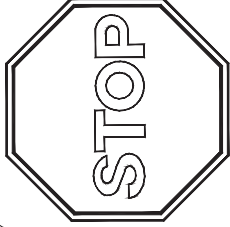

DO NOT RETURN PRODUCT TO THE STORE  
Individual stores do not stock parts.

Lot Number: \_\_\_\_\_

Date Of Purchase: \_\_\_\_ / \_\_\_\_ / \_\_\_\_

If a part is missing or damaged, call our toll-free customer service line.  
We will gladly ship your replacement parts FREE of charge.

Need Parts or Assistance?

**1-800-489-3351**

or access our website

[www.ameriwood.com/parts](http://www.ameriwood.com/parts)

For prompt, reliable service please have your assembly manual ready.

Recommended # of people needed for assembly:2  
(However it is always better to have an extra hand.)

Spanish translations are located in the center of this manual.

07312019MP

B347085222W00MP

Thank you for purchasing from AMERIWOOD.

Visit [www.ameriwood.com](http://www.ameriwood.com) to view the limited warranty valid in the U.S. and Canada.

## BEFORE STARTING

- Read each step carefully before starting. It is very important that each step of instruction is performed in the correct order. If these steps are not followed in sequence, assembly difficulties will occur.
- Make sure all parts are included. Most board parts are labeled or stamped on the raw edge.
- Work in spacious area, preferably on a carpet, near the place the unit will be used.
- Have the following tools close at hand.
- Do not use power tools to assemble your furniture. Power tools may strip or damage the parts.

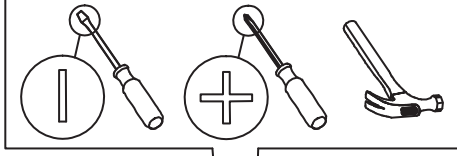

## HELPFUL HINTS

- Visit our website for assembly video clips.
- Call our toll free number if you need assistance.
- Compression dowels are tapped in with a hammer.
- Back panels provide stability and support. Use all the nails provided. Units without the back panel installed may collapse.
- When tapping nails into a board, be sure there are equal margins on all side to square the unit.
- Move your new furniture carefully, with two people lift and carry the unit to it's new location.
- Never push, drag or scot your furniture (especially on carpet).
- Your ALTRAFURNITURE can be disassembled and reassembled to move.
- Additional parts are available for a nominal fee.

For help with assembly, identifying parts, product information or to order parts, please contact us:



Call us at: **1-800-489-3351**

Monday-Friday

9:00 am - 5:00 pm  
(Central Time)



FAX:

**1-636-745-1005**

available 24 hours a day,  
7 days a week



Visit our website:

[www.ameriwood.com/parts](http://www.ameriwood.com/parts)



Write to:

**AMERIWOOD INDUSTRIES**  
410 East 1st Street South  
Wright City, MO 63390 USA  
Attn: Service Dept.

PARTS

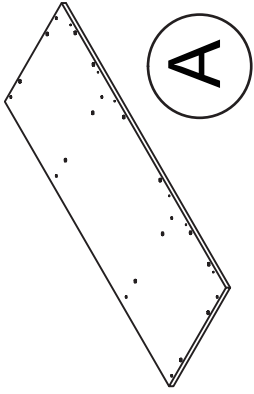

TOP  
T7085222010MP

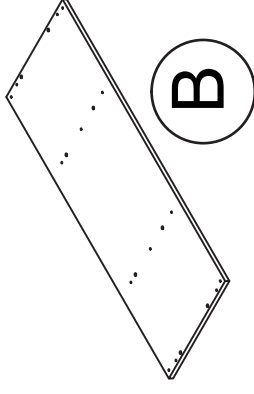

BOTTOM  
T7085222020MP

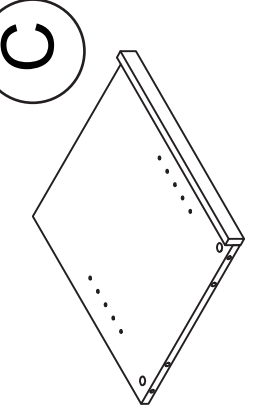

LEFT SIDE PANEL  
T7085222030MP

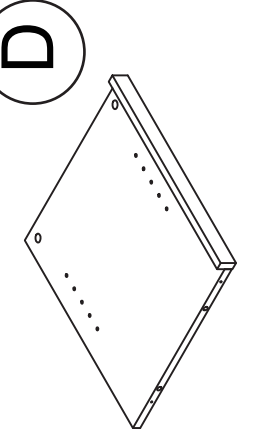

RIGHT SIDE PANEL  
T7085222040MP

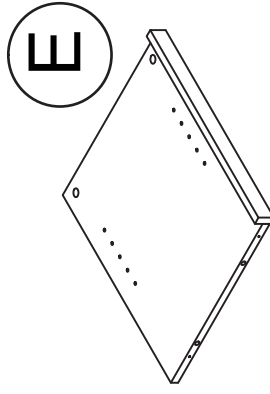

LEFT PARTITION  
T7085222050MP

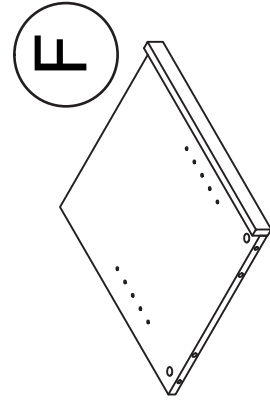

RIGHT PARTITION  
T7085222060MP

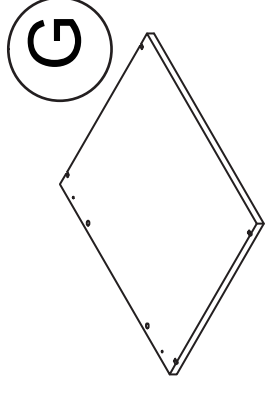

ADJUSTABLE SHELF  
T7085222070MP

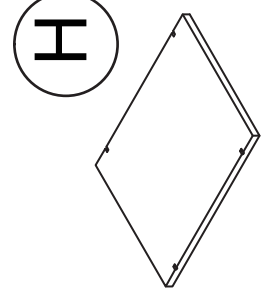

ADJUSTABLE SHELF  
T7085222080MP

Qty: 2

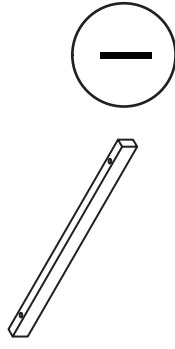

RAIL  
T7085222090MP  
Qty: 2

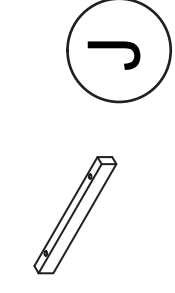

RAIL  
T7085222100MP  
Qty: 2



FOOT  
T7085222110MP  
Qty: 6

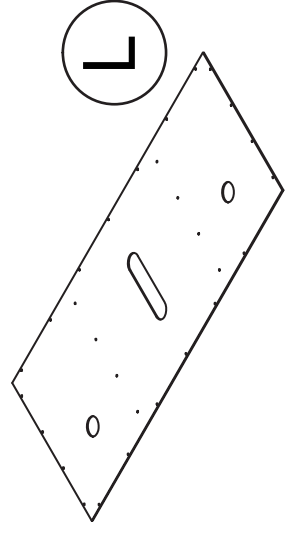

BACK PANEL  
T7085222120MP

This illustration shows how the CAM fastening system works.

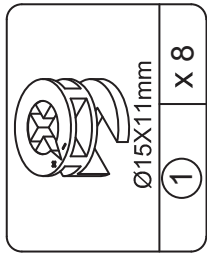

**CAM LOCK**  
TMP5007  
spare:1

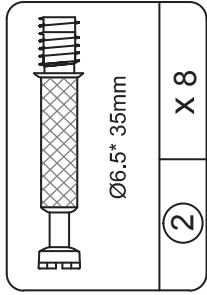

**CAM BOLT**  
TMP5101  
spare:1

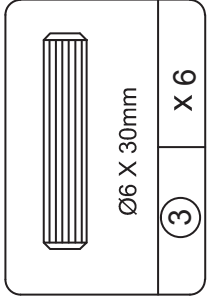

**WOOD DOWEL**  
TMP8002  
spare:1

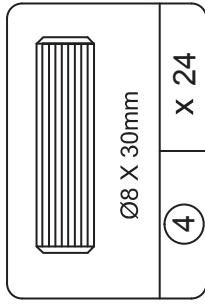

**WOOD DOWEL**  
TMP8001  
spare:1

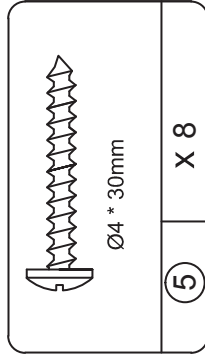

**SCREW**  
TMP4502  
spare:1

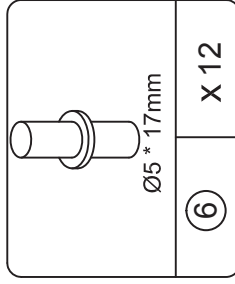

**SHELF SUPPORT**  
TMP6005  
spare : 1

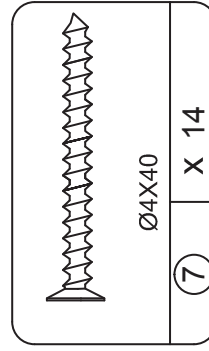

**SCREW**  
TMP4205  
spare:1

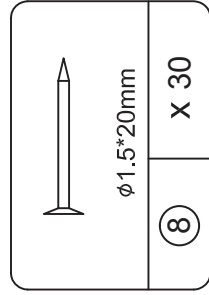

**NAIL**  
TMP4703  
spare:1

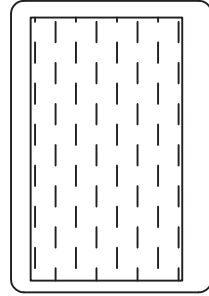

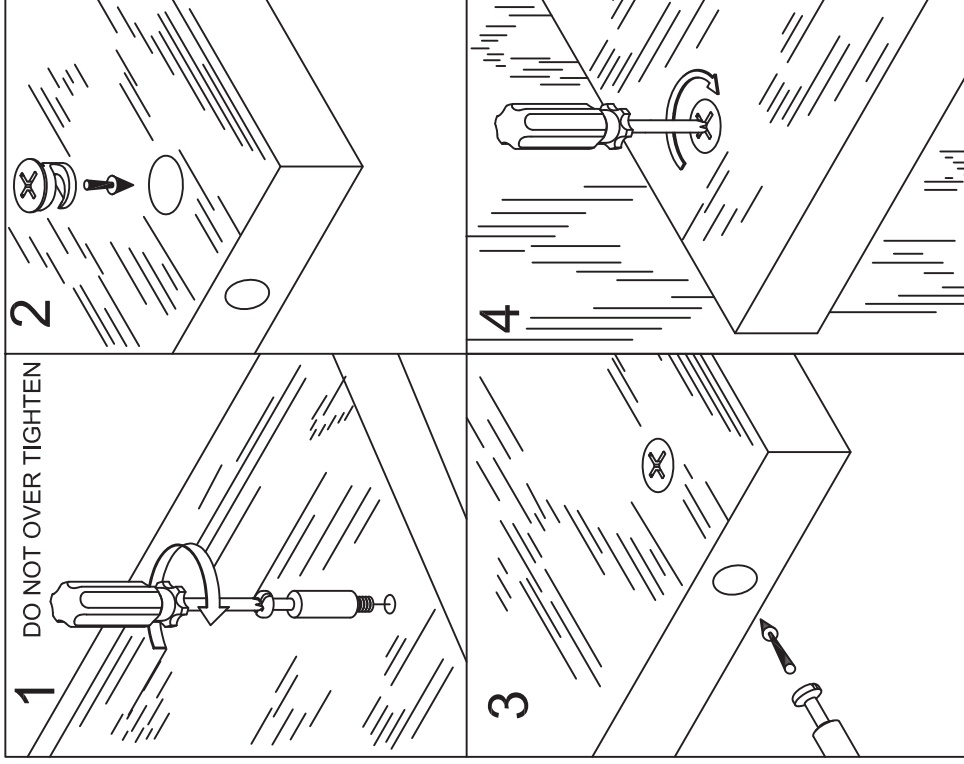

**WARNING LABEL**  
TMP 7085

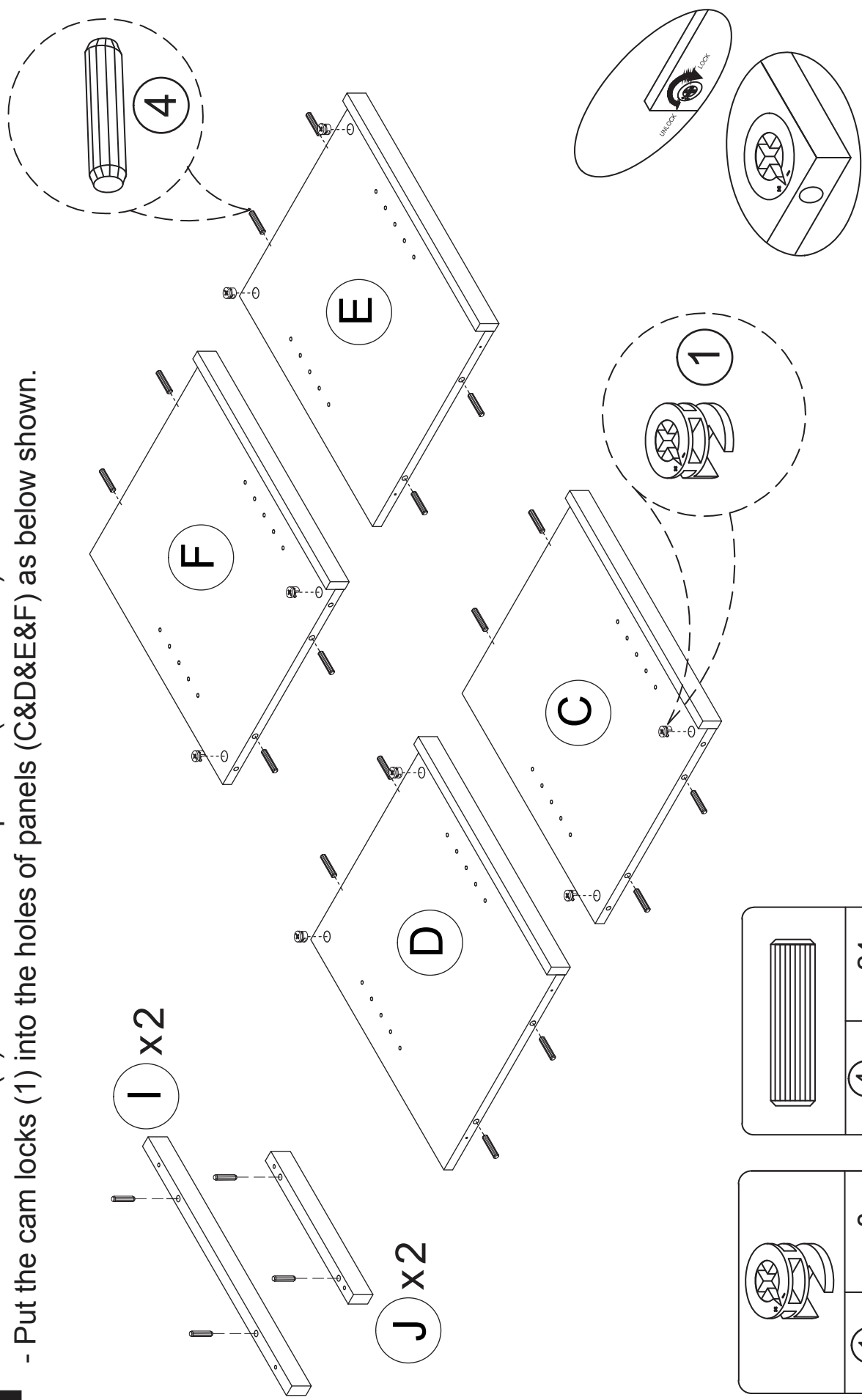

To view a video on how the CAM fastening system works, download a free QR-reader on your smartphone, then scan the code.

- 1**
- Insert wood dowels (4) into the holes of rails (I&J) as below shown.
  - Insert wood dowels (4) into the holes of panels (C&D&E&F) as below shown.
  - Put the cam locks (1) into the holes of panels (C&D&E&F) as below shown.

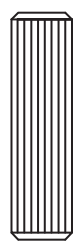

	(1)	x 8
	(4)	x 24

Proper orientation of CAM LOCK

# 2

- Screw cam bolts (2) into the holes of panels (A) as below shown.
- Attach rails (I&J) to the panel (A) with screw (5) as below shown.

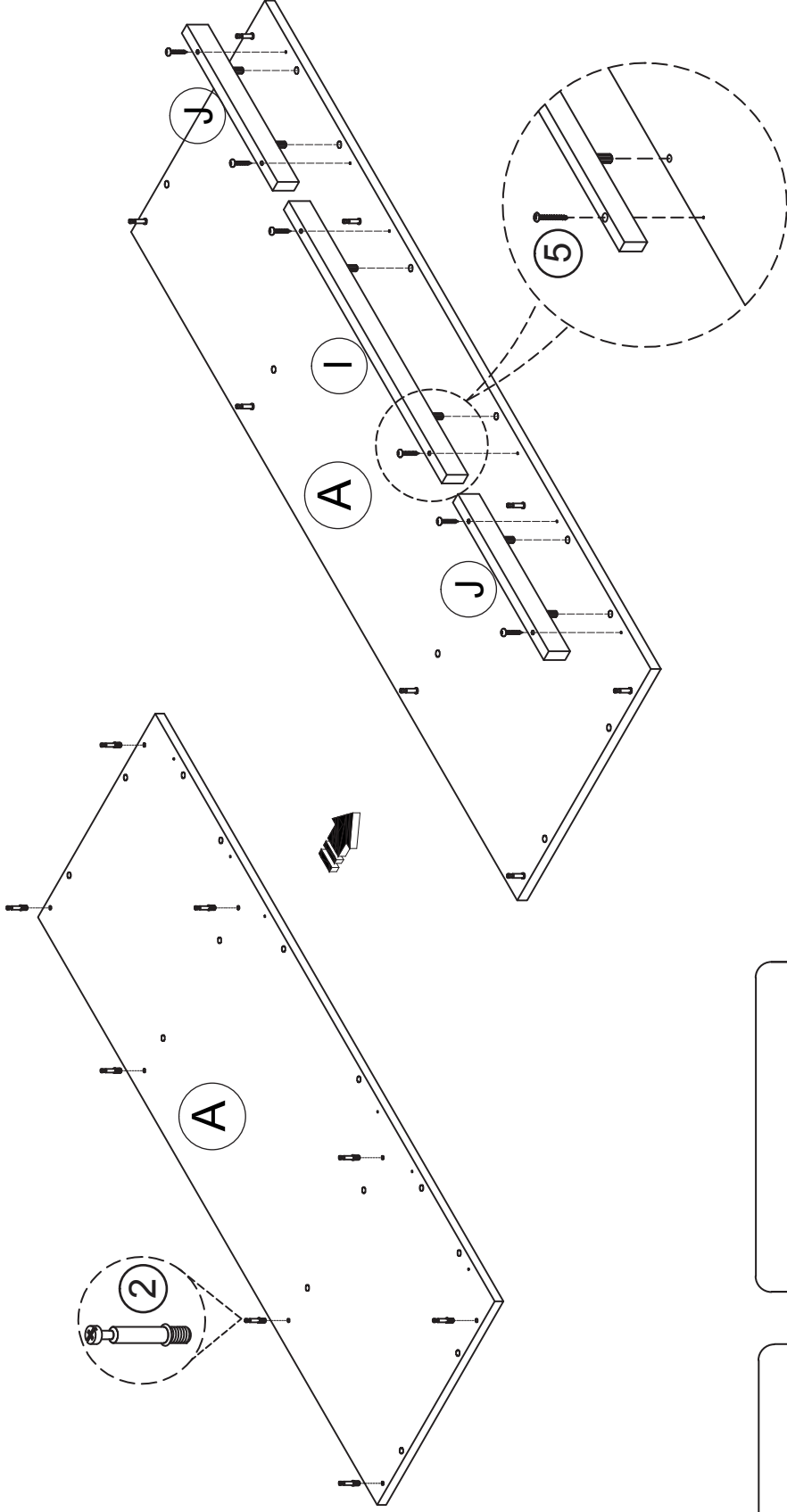

	2	x 8
--	---	-----

	5	x 6
--	---	-----

# 3

- Attach panels (C&D&E&F) into the top panel (A) as below shown.

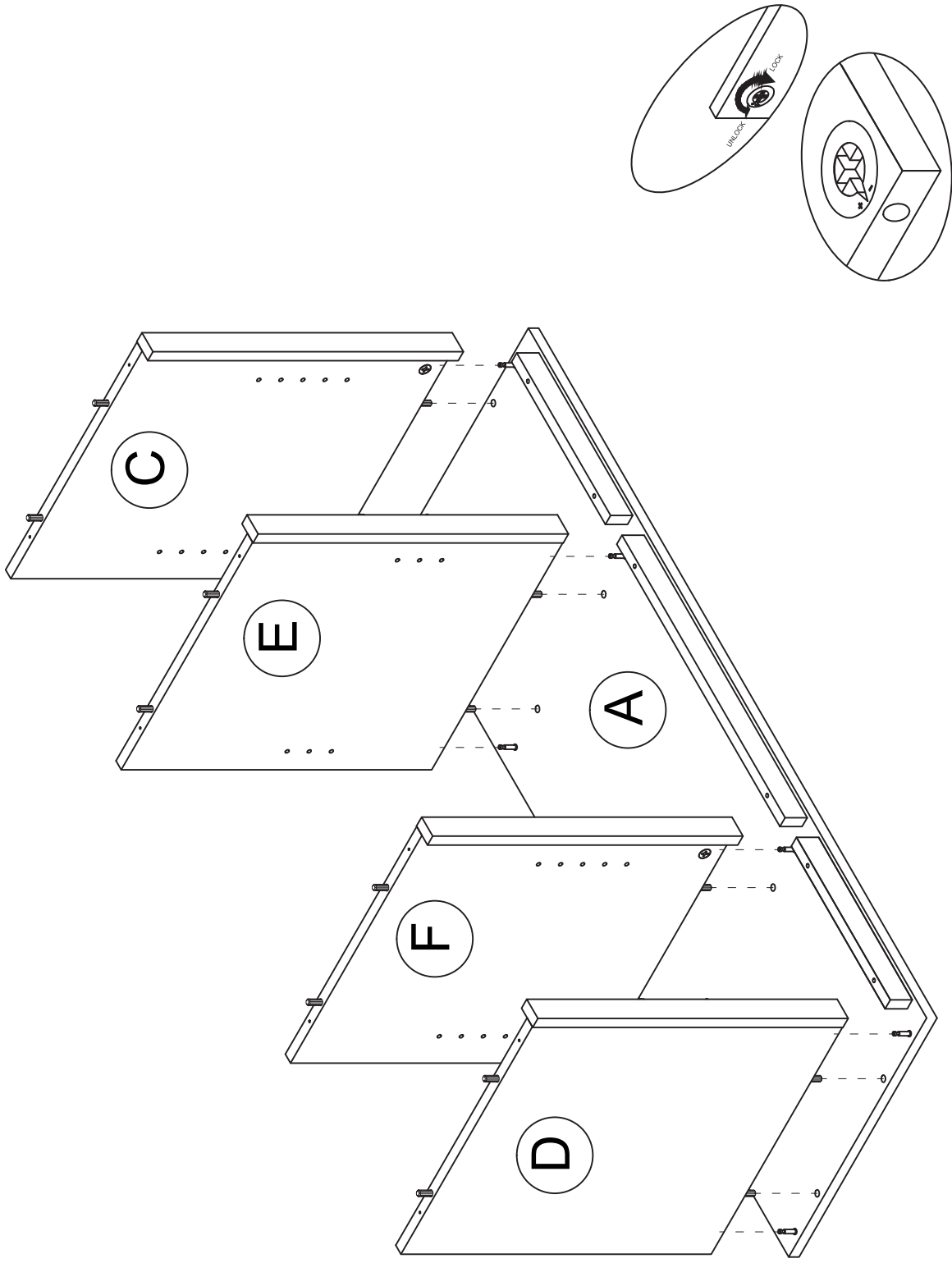

Proper orientation of CAM LOCK

# 4

- Insert wood dowels (3) into the holes of feet (K) as below shown.
- Attach feet (K) to assembled bottom panel (B) with screw (7) as below shown.

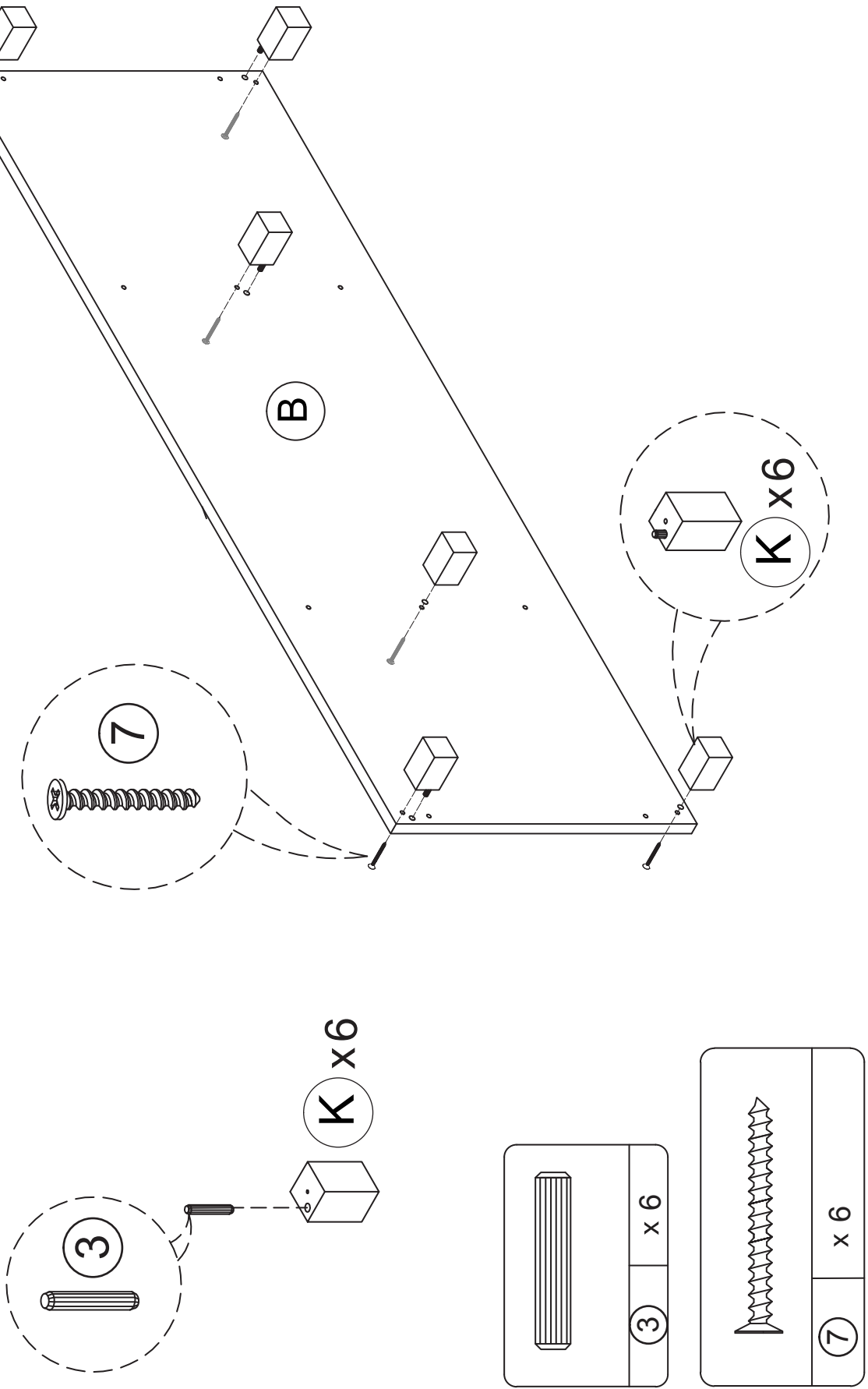

# 5

- Attach bottom panel (B) to assembled unit with screw (7) as below shown.

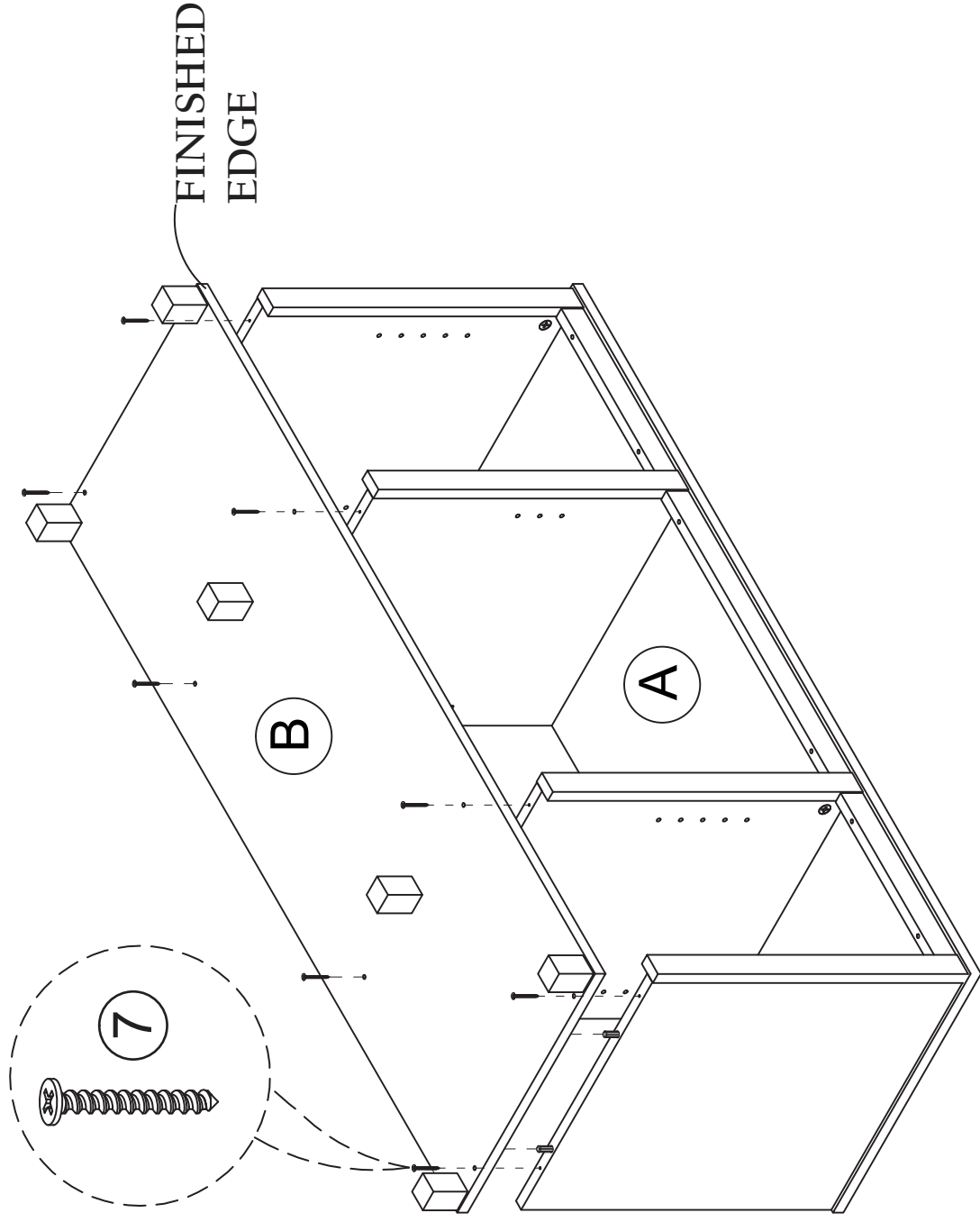

⑦	x 8

# 6

- Turn the unit as below shown.
- Attach back panel (L) to assembled unit with nails (8) as below shown.

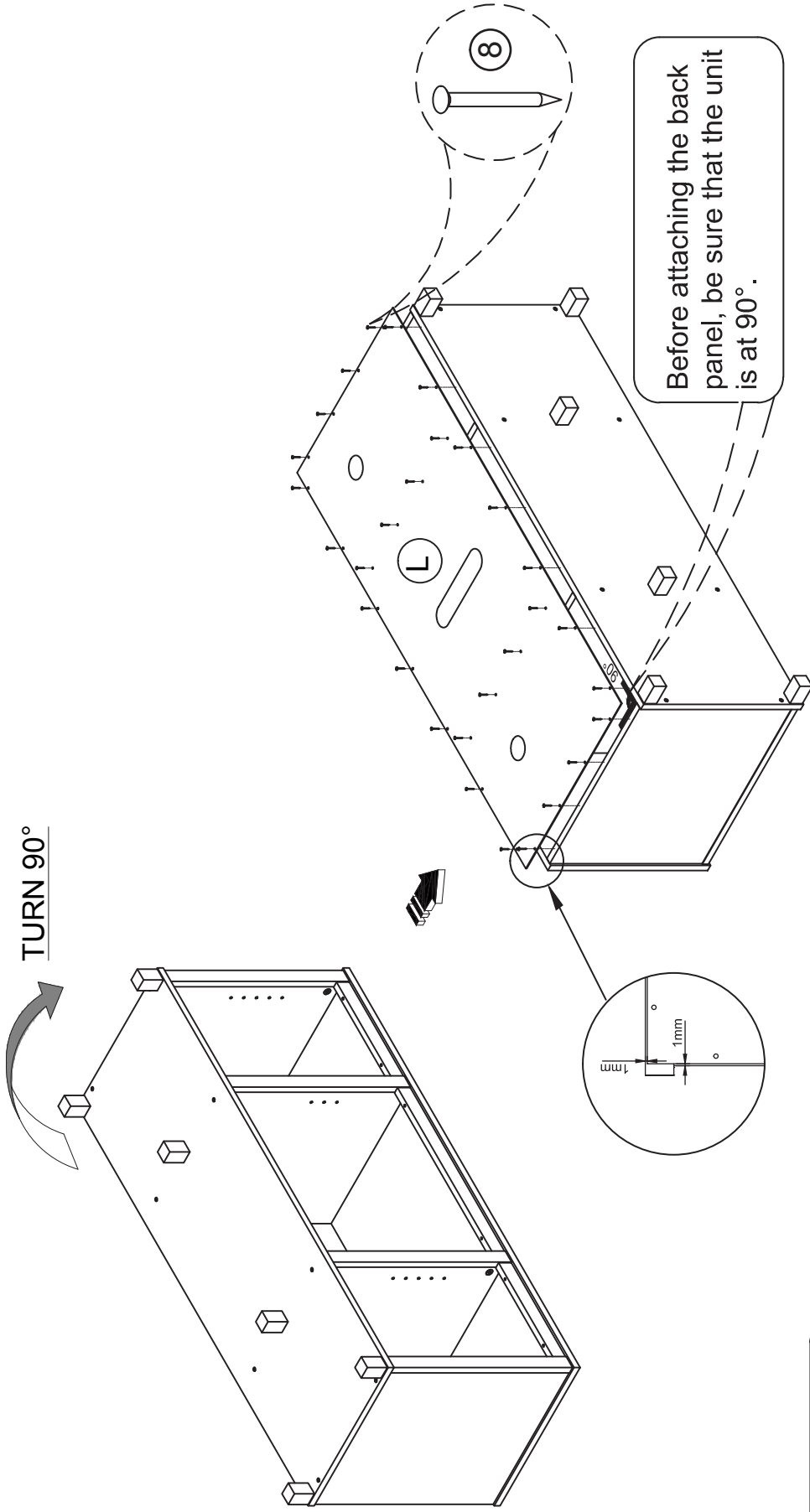

	(8)	x 30
---	-----	------

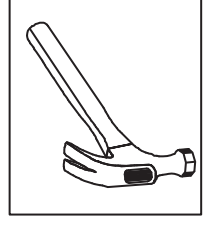



Call our toll free number for any assistance you should need or visit our website:

**1-800-489-3351**

[www.ameriwood.com](http://www.ameriwood.com)

### WEIGHT LIMITS:

Clean the product with your favorite furniture polish and a soft cloth. Do not use harsh chemicals or abrasive cleaners.

Before moving the unit, remove everything including TV from the unit. Move your new furniture carefully with two people. Lift and carry the unit. Never push or drag the unit.

Do not allow children to climb or play on the unit. Failure to comply could result in severe injury.

This unit has been designed to support the maximum loads shown. Exceeding these load limits could cause unit sagging, instability, product collapse and/or serious injury.

Apply the warning label to the TV stand as shown, be sure the TV covers the label in use. You will not be able to remove the label after it is applied to the TV stand.

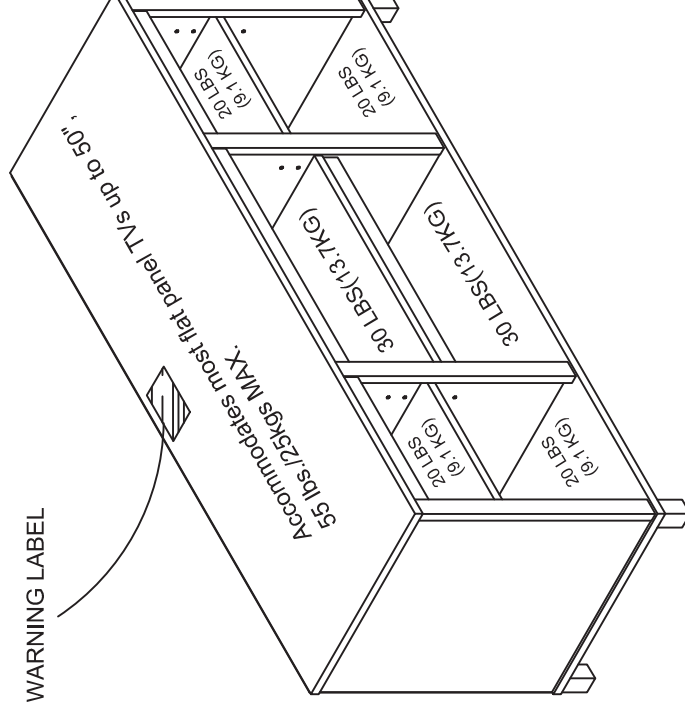

# Enjoy Your Furniture