

Smart Toilet USER MANUAL

Model No: CU111-1111111100
SKU:N753P256132G

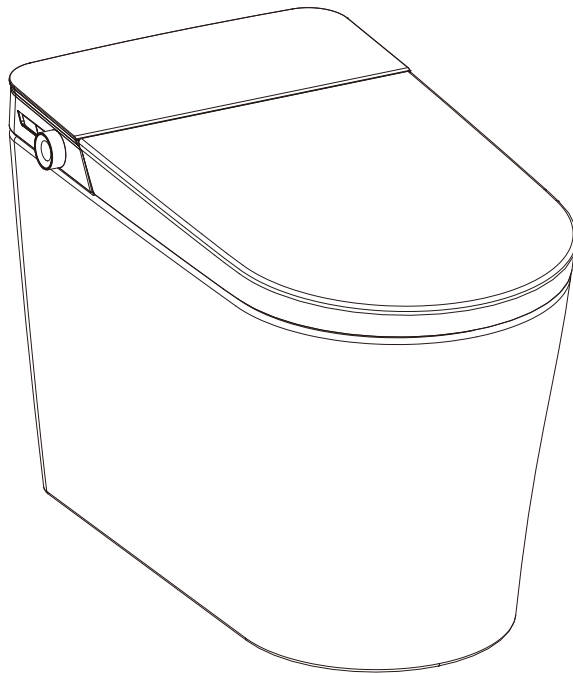

Edition: V 2024.11.27

IMPORTANT SAFEGUARDS

When using electrical products, especially when children are present, basic safety precautions should always be followed, including the following:

READ ALL INSTRUCTIONS BEFORE USING

DANGER – To reduce the risk of electrocution:

Do not use while bathing.

1. Do not pour water or detergent on the power plug. It may cause fire, electric shock and other accidents.
Ne versez pas d'eau ou de détergent sur la prise d'alimentation. Cela peut causer un incendie, un choc électrique ou d'autres accidents.
2. Do not bring lit cigarettes or burning species close to the product. It may cause a fire.
N'amenez pas de cigarettes allumées ou d'espèces en feu à proximité du produit. Cela pourrait provoquer un incendie.
3. Please do not continue to use the product when the product fails. Please contact the after-sales service staff for maintenance. When the following situation occurs, please remove the power plug and close the inlet angle valve.

- ① Leakage from the inside of the product line;
- ② The product is unusually hot;
- ③ The product makes an abnormal sound and smell;
- ④ The product is burnt.

If the product is still used in the event of malfunction, it may cause problems such as fire, electric shock, water inflow in the room. (The normal life of this product is six years, the continued use beyond the service life may lead to accidents.)

Veuillez ne pas continuer à utiliser le produit lorsqu'il tombe en panne. Veuillez contacter le personnel du service après-vente pour la maintenance. Lorsque la situation suivante se produit, veuillez retirer la fiche d'alimentation et fermer la vanne d'angle d'entrée.

- ① Fuite de l'intérieur de la ligne de produits;
- ② le produit est anormalement chaud;
- ③ le produit émet un bruit et une odeur anormaux;
- ④ le produit est brûlé.

Si le produit est encore utilisé en cas de dysfonctionnement, il peut causer des problèmes tels qu'incendie, choc électrique, infiltration d'eau dans la pièce (la durée de vie normale de ce produit est de six ans, la poursuite de son utilisation au-delà de la durée de vie peut entraîner des accidents).

4. ① This product belongs to the electrical products, do not put it in places where there is water or the places of high humidity. When used in the bathroom, please install ventilation fan or ventilation port to keep the bathroom in good air circulation. Otherwise, it may cause a fire or electric shock.
② If the power cord is damaged, do not disassemble it yourself and must be replaced by the manufacturer or its service department or relative department.
① Ce produit est un produit électrique, ne le placez pas là où il y a de l'eau ou où l'humidité est élevée. Ne le mettez pas dans des endroits où il y a de l'eau ou des endroits très humides. Lorsqu'il est utilisé dans la salle de bain, veuillez installer un ventilateur ou un orifice de ventilation pour maintenir la salle de bain en bonne circulation d'air. Dans le cas contraire, cela pourrait provoquer un incendie ou un choc électrique.
② Si le cordon d'alimentation est endommagé, ne le démontez pas vous-même et il doit être remplacé par le fabricant ou son service après-vente ou le service concerné.

WARNING – To reduce the risk of burns, electrocution, fire, or injury to persons.

1. Close supervision is necessary when this product is used by, on, or near children or invalids.
2. Use this product only for its intended use as described in this manual. Do not use attachments not recommended by the manufacturer.
3. Never operate this product if it has a damaged cord or plug, if it is not working properly, if it has been dropped or damaged, or dropped into water. Return the product to a service center for examination and repair.
4. Keep the cord away from heated surfaces.

Dear customers,

Thank you for purchasing our intelligent toilet series products, to ensure safety before using this product, please read this instruction carefully and keep it carefully for reference.

IMPORTANT SAFEGUARDS	02
PRODUCT FUNCTIONS	06
SIDE BUTTON USING GUIDE	07
PACKING LIST	08
PRODUCT SIZE	08
TECHNICAL DATA	09
PRECAUTIONS BEFORE INSTALLATION	10
PRODUCT INSTALLATION METHODS	10
PRODUCT CLEANING AND MAINTENANCE METHODS	12
HOW TO DEAL WITH COMMON PROBLEMS	13
REMOTE CONTROL USER MANUAL	14
BATTERY QUANTITY OF REMOTE CONTROL	15

- Before beginning installation, read all instructions first. Save these instructions for future use.
- This product is subject to standard of UL 1431.

5. Never block the air openings of the product or place it on a soft surface, such as a bed or couch, where the air openings may be blocked. Keep the air openings free of lint, hair, and the like.
6. Never use while sleeping or drowsy.
7. Never drop or insert any object into any opening or hose.
8. Do not use outdoors or operate where aerosol (spray) products are being used or where oxygen is being administered.
9. Connect this product to a properly grounded outlet only. See Grounding Instructions.
10. It is absolutely forbidden to disassemble, repair and transform this product by yourself.
It may cause fire, electric shock and other accidents.
Il est absolument interdit de démonter, réparer et transformer ce produit par vous-même.
Il peut causer un incendie, un choc électrique et d'autres accidents.
12. Only tap water can be used. Otherwise may cause infectious dermatitis and other diseases.
N'utilisez que de l'eau courante. Sinon, cela peut causer une dermatite infectieuse et d'autres maladies.
13. Forbiddance sitting on the seat for a long time, the seat temperature should be adjusted in low-grade, please note that low-temperature burns. The following personnel should set the seat temperature at low-grade when using the toilet.
 - ① Children and elderly people who cannot adjust the temperature to the right degree.
 - ② Patients, persons with disabilities and other people who can not move freely.
 - ③ Lethargic crowd because of taking hypnotics (Such as sleeping pills, cold medicine, etc.) deep drinking and over fatigue.Ne vous asseyez pas sur le siège pendant une longue période, la température du siège doit être ajustée en bas de gamme, veuillez noter les brûlures à basse température. Les personnes suivantes doivent régler la température du siège à un niveau bas lorsqu'elles utilisent les toilettes.
 - ① Les enfants et les personnes âgées qui ne peuvent pas régler la température au bon degré.
 - ② Les patients, les personnes handicapées et les autres personnes qui ne peuvent pas se déplacer librement.
 - ③ Les personnes léthargiques en raison de la prise d'hypnotiques (tels que les somnifères, les médicaments contre le rhume, etc.), de la consommation d'alcool et de la fatigue excessive.
14. Do not forcibly stretch the connecting pipe of the water supply pipe. Otherwise it may cause water leakage.
Ne pas étirer de force le tuyau de raccordement de la conduite d'alimentation en eau. Sinon, cela pourrait provoquer des fuites d'eau.
15. Defecation clean function, a special cleaning function, only allowed to use one time whenever you use the toilet, non-repeated use!
La fonction de nettoyage de la défécation, une fonction de nettoyage spéciale, ne peut être utilisée qu'une seule fois à chaque fois que vous utilisez les toilettes, usage non répété!
16. Do not rely on the seat cover or forcibly press the control panel. Otherwise it may result in malfunction or breakage. Forced application of force may cause seat cover and control panel damage, resulting in personal injury.
Ne vous fiez pas à la housse du siège et n'appuyez pas de force sur le panneau de commande. Sinon, cela pourrait entraîner un dysfonctionnement ou une rupture.
L'application forcée de la force peut endommager la housse du siège et le panneau de contrôle, ce qui peut entraîner des blessures.
17. Do not place containers containing liquid such as vials, cups, cosmetics, pharmaceuticals, etc. or small metal objects on top of the product. Inadvertent entry into the product may result in fire or electric shock.
Ne placez pas de récipients contenant des liquides, tels que des flacons, des tasses, des cosmétiques, des produits pharmaceutiques, etc. Ou de petits objets métalliques sur le dessus du produit. L'entrée accidentelle dans le produit peut entraîner un incendie ou une électrocution.
18. Do not place the product in direct sunlight, otherwise the appearance of products may be aging deformation.
Ne placez pas le produit à la lumière directe du soleil, sinon l'apparence du produit peut vieillir et se déformer.

19. Do not use the toilet to flush expect shit, urinate and toilet paper, or it may cause toilet jam, sewage overflow.
N'utilisez pas la chasse d'eau pour vous attendre à ce que vous chiez, urinez et utilisez du papier toilette, car cela pourrait provoquer un blocage des toilettes ou un débordement des eaux usées.
20. Please do not hit the ceramic to prevent damages that result in leakage.
Veuillez ne pas frapper la céramique afin d'éviter des dommages qui pourraient entraîner des fuites.
21. Please do not use in the environment below 3°C.
S'il vous plaît ne pas utiliser dans un environnement inférieur à 3 °C.
22. When installing the inlet angle valve, please tighten firmly. Otherwise it will lead to water leakage.
Lors de l'installation de la vanne d'angle d'entrée, veuillez la serrer fermement. Sinon, cela entraînera des fuites d'eau.
23. Prevent damage caused by freezing. Freezing can cause damage to the water hose and product interiors and cause water leakage.
Prévenir les dommages causés par la congélation. La congélation peut endommager le tuyau d'eau et à l'intérieur du produit et entraîner des fuites d'eau.
24. When traveling for long periods of time or when not in use, please unplug the power plug from the outlet.
En cas de long voyage ou de non-utilisation, veuillez débrancher la prise de courant.
25. This product is only for bathroom, and should not be used for any purposes other than the ones described in this manual. Otherwise maybe cause to fire, electric shock, personal injury or malfunction.
Ce produit est destiné uniquement aux salles de bains et ne doit pas être utilisé à d'autres fins que celles décrites dans ce manuel. Sinon, cela peut causer un incendie, un choc électrique, des blessures Ou l'échec.
26. Do not allow urine and other contaminants to touch the smart toilet. Doing so may cause odor or cause malfunction.
Ne laissez pas l'urine et les autres polluants entrer en contact avec les toilettes intelligentes. Cela peut causer des odeurs ou causer des problèmes.
27. Do not forcibly close the seat and seat cover. It is necessary to avoid the collision of the seat lid and the seat cover when turning them. Otherwise maybe cause malfunction.
Don't clip to the fingers while seat and seat cover switch, otherwise maybe cause bruise.
Ne fermez pas de force les sièges et les housses de siège. Évitez la collision du couvercle de siège et du couvercle de siège lors de la rotation. Sinon, cela peut entraîner un échec. Ne pas couper à Interrupteur de siège et de siège lorsque le doigt, sinon il peut causer des ecchymoses.

SAVE THESE INSTRUCTIONS

DANGER – Improper use of the grounding plug can result in a risk of electric shock.

1. Do not use loose power outlet. It may cause a fire or electric shock.
N'utilisez pas de prise de courant mal fixée. Cela peut causer un incendie ou un choc électrique.
2. Please use the power outlet within the specified conditions (110-120V~, 13A, 60Hz socket).
Do only use 110-120V~ power supply. Using power beyond the socket regulations may cause the socket to heat up and cause a fire.
Veuillez utiliser la prise de courant dans les conditions spécifiées (prise 110-120V ~, 13A, 60Hz). Utilisez seulement l'alimentation électrique de 110-120V~. L'utilisation d'une alimentation électrique non conforme à la réglementation sur les prises peut entraîner un réchauffement de la prise et provoquer un incendie.
3. Do not damage the power cord and seat wire.
 - ① Do not damage, do not process, do not heat;
 - ② Do not force bending, do not curly tied, do not pull;
 - ③ Do not put heavy objects on the power cord and the seat lid connection, ignoring product damage and continuing to use may result in fire, electric shorts and other conditions.
N'endommagez pas le cordon d'alimentation et le fil du siège.
 - ① ne pas endommager, ne pas traiter, ne pas chauffer;
 - ② ne pas forcer la flexion, ne pas lier, ne pas tirer;

- ③ ne pas poser d'objets lourds sur le cordon d'alimentation et le raccord du couvercle du siège, en ignorant les dommages causés par le produit et en continuant à l'utiliser, ce qui pourrait provoquer un incendie, des court-circuits électriques et d'autres problèmes.
4. Please check if grounding is done. A product that is not grounded may cause an electric shock in the event of a malfunction or leakage.
Veuillez vérifier si la mise à la terre est effectuée. Un produit qui n'est pas mis à la terre peut provoquer un choc électrique en cas de dysfonctionnement ou de fuite.
 5. Unplug the power plug when lightning occurs.
Débranchez la prise d'alimentation lorsque la foudre se produit.
 6. For external maintenance, unplug the power plug from the socket for safety reasons. Otherwise maybe get an electric shock.
Pour la maintenance externe, débranchez la prise d'alimentation de la prise pour des raisons de sécurité. Sinon, il peut être électrocuté.

GROUNDING INSTRUCTIONS

This product should be grounded. In the event of an electrical short circuit, grounding reduces the risk of electric shock by providing an escape wire for the electric current. This product is equipped with a cord having a grounding wire with a grounding plug. The plug must be plugged into an outlet that is properly installed and grounded.

DANGER— Improper use of the grounding plug can result in a risk of electric shock.

If repair or replacement of the cord or plug is necessary, do not connect the grounding wire to either flat blade terminal. The wire with insulation having an outer surface that is green with or without yellow stripes is the grounding wire.

Check with a qualified electrician or serviceman if the grounding instructions are not completely understood, or if in doubt as to whether the product is properly grounded.

This product is for use on a nominal 120 V circuit, and has a grounding plug that looks like the plug illustrated in sketch A in below Grounding methods. A temporary adapter, which looks like the adapter illustrated in sketches B and C, may be used to connect this plug to a 2-pole receptacle as shown in sketch B if a properly grounded outlet is not available. The temporary adapter should be used only until a properly grounded outlet (sketch A) can be installed by a qualified electrician. The green colored rigid ear, lug, and the like extending from the adapter must be connected to a permanent ground such as a properly grounded outlet box cover. Whenever the adapter is used, it must be held in place by the screw.

Grounding methods

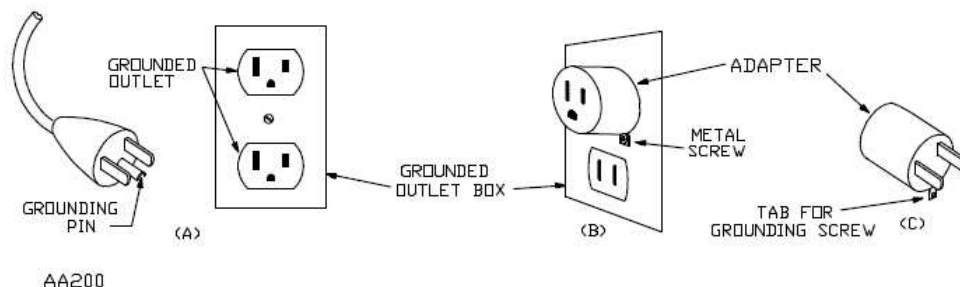

This device complies with Part 15 of the FCC Rules. Operation is subject to the following two conditions:

(1) this device may not cause harmful interference, and (2) this device must accept any interference received, including interference that may cause undesired operation.

Caution: The user is cautioned that changes or modifications not expressly approved by the party responsible for compliance could void the user's authority to operate the equipment.

Note: This equipment has been tested and found to comply with the limits for a Class B digital device, pursuant to part 15 of the FCC Rules. These limits are designed to provide reasonable protection against harmful interference in a residential installation. This equipment generates uses and can radiate radio frequency energy and, if not installed and used in accordance with the instructions, may cause harmful interference to radio communications. However, there is no guarantee that interference will not occur in a particular installation. If this equipment does cause harmful interference to radio or television reception, which can be determined by turning the equipment off and on, the user is encouraged to try to correct the interference by one or more of the following measures:

- Reorient or relocate the receiving antenna.
- Increase the separation between the equipment and receiver.
- Connect the equipment into an outlet on a circuit different from that to which the receiver is connected.
- Consult the dealer or an experienced radio/TV technician for help.

This device contains licence-exempt transmitter(s)/receiver(s) that comply with Innovation, Science and Economic Development Canada's licence-exempt RSS(s). Operation is subject to the following two conditions:

- (1) This device may not cause interference.
- (2) This device must accept any interference, including interference that may cause undesired operation of the device.

L'émetteur/récepteur exempt de licence contenu dans le présent appareil est conforme aux CNR d'Innovation, Sciences et Développement économique Canada applicables aux appareils radio exempts de licence. L'exploitation est autorisée aux deux conditions suivantes:

- (1) L'appareil ne doit pas produire de brouillage;
- (2) L'appareil doit accepter tout brouillage radioélectrique subi, même si le brouillage est susceptible d'en compromettre le fonctionnement.

Product functions

Heated Seat, Soft Night Light, Energy Saving, Warm Air Drying, Rear Wash, Defecation clean, Front Wash, Moving Clean, One Touch, Nozzle Cleaning, Nozzle Self-clean, Auto flush, Foot sensor flush, Remote control flush, Power-off flush, user defined, ambient light, Adjustable Water Temperature, Seat Temperature, Air Temperature, Water Pressure and nozzle position, Auto Open Seat/Cover.

Side button using guide

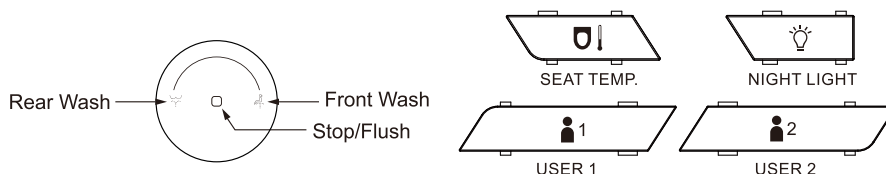

Please follow up the process below before product operation.

1. Turn on the valve.
2. Plug the power cord into electrical inlet.

Standby Model

In state of no seated, Long press the side button or "STOP /FLUSH" on the remote for more than 3 seconds to enter standby mode, When in standby mode, quickly press the side button to exit. In cleaning mode, quickly press the side button to exit the current cleaning mode.

Rear Wash

In the seated mode with no cleaning action, rotate counterclockwise to enter Rear wash.

Front Wash

In the seated mode with no cleaning action, rotate clockwise to enter Front wash.

When in the Rear /Front wash, quickly rotate clockwise or counterclockwise to adjust the nozzle position. Long rotate clockwise to start moving clean, long counterclockwise to exit it.

Air Dryer

In the seated mode with no cleaning action, long press the side button for 3 seconds to start air drying, in air dry mode: quickly rotate clockwise or counterclockwise to adjust the air temperature.

Seat Temperature

Quickly press the Seat temp side button to turn on/off the heated seat. (Room temp and 37 degrees)

Flush

a . Foot induction flush:

In the state of no seated, trigger foot sensing at the first time, flip the seat ring, and trigger the second time, and flush once. In the state of seated, the foot sensor not work.

b . Side button flush:

In the state of no cleaning and drying, quickly press to flush once.

c . Power-off flush :

When there is no electricity, quickly press to flush once.

User defined

In the state of no seated, press button "User 1/2" to enter setting mode, it can set rear wash, front wash, wind /seat / water temperature, water pressure, nozzle position, moving clean, after setting, long press the User 1 or 2 to save, when you hear two ding ding sounds, means save successful.

In the state of seated, quickly press "User 1/2" to enter the set cleaning mode, After the cleaning is completed, it will automatically flush and dry. During this process, the gear can be reset, and long press the user 1/2 to save. Quickly press the same user button during cleaning: turn on/off moving clean.

Automatic lid cover flip

When it is close to the toilet, it will automatically open the lid. After the lid is opened, if no human activity is detected within 5 minutes, the lid will automatically close.

Automatic seat flip

When the seat is not lifted, trigger the foot sensor to lift the seat, and when the seat is lifted, trigger the foot sensor to close the seat and flush once.

Night light and ambient light

Press the "NIGHT LIGHT" on the side button or remote control to turn on /off the the night light and ambient light.

Packing list

No.	Name	Quantity	No.	Name	Quantity
1	Smart Toilet	1	10	Remote Control User Manual	1
2	User Manual	1	11	Remote Screw	2
3	Remote Controller	1	12	G1/2 To G3/4 Angle Valve	1
4	Remote Expansion Nut	2	13	9V Battery	1
5	AAA Battery	2	14	Flange seal ring	1
6	Battery Box	1	15	Filter	1
7	Water Flow Restrictor	1	16	Screw nut	2
8	Flange Mount Kit	1	17	G1/2 to 1/2-14NPSM Adapter	1
9	Ceramic Mount Kit	1	18	5L drain bag	1

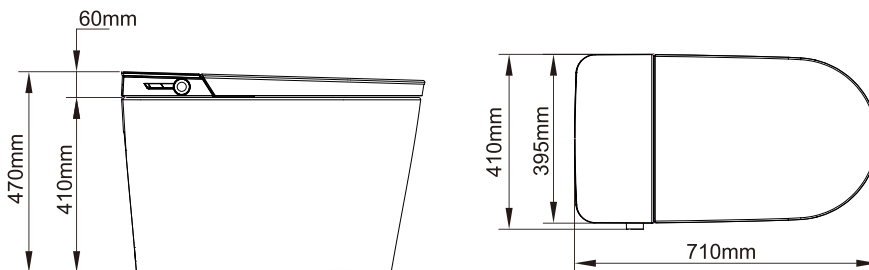
Product size

Technical data

Rated voltage		110-120V~	
Rated frequency		60Hz	
Rated power		1050W (15°C±1°C inlet water temperature)	
Min water supply flow		25L/min	
Water supply mode		Directly connected to the channel	
Ambient temperature		About 3°C to 40°C	
Water supply temperature		About 3°C to 35°C	
Water pressure range		Dynamic water pressure 0.14MPa - Static water pressure 0.8MPa	
Min working pressure		0.14MPa	
Safety devices		Electrical leakage protector, seated sensor, water over-pressure protection device	
Decontaminating apparatus	Heating method		Instant heating
	Warm water temperature		Four grades (Room temperature to 40°C)
	Spray volume	Buttock cleaning	About 0.35 to 0.65L/min
		Women-only	About 0.35 to 0.65L/min
	Warm water heater		1100W
	Safety appliance		Temperature sensor, temperature fuse, temperature jumper, flowmeter
Drying device	Wind speed		>4m/s
	Air temperature		Four grades (Room temperature to 40°C)
	Drying heater		200W
	Safety devices		Double-sheet-metal switch, temperature fuse
Thermal seat	Seat temperature		Four grades (Room temperature to 40°C)
	Seat heater		45W
	Safety devices		Temperature sensor, temperature fuse, temperature sensor
	Switch structure		Damping slowdown

Rated power: at room temperature 20±5°C, inlet water static pressure is 0.18±0.02MPa. The average power of turning on the cleaning function and working steadily for one cleaning cycle at the inlet temperature of 15±1°C.

Precautions before installation

1. Installation space

- ① To ensure that there is enough space for installation at the same time, please confirm the door switch does not affect the product's installation. The distance of water inlet pipe to the ground should be more than 150mm.
- ② Before installation, please confirm the location of the outfall and wax seal (For specific location please refer to the logo shown on the right)

2. Installation diagram

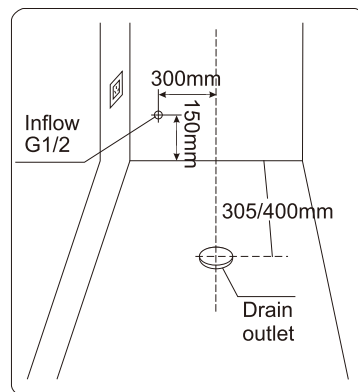
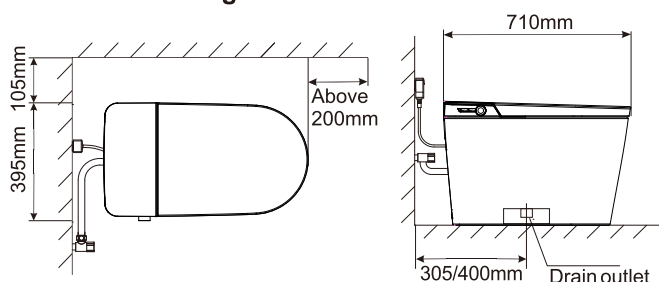

Product installation methods

1. The installation of flanges and ceramics

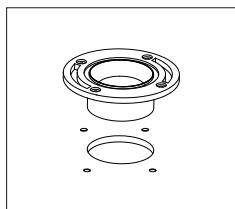

1. According to the position of the four screw holes of the flange, make four holes around the floor drain outlet, and drive in expansion screws to fix the flange.

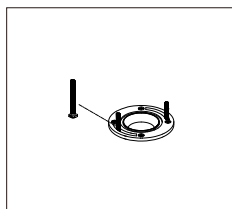

2. Insert the toilet mounting bolts into the grooves of the flange, then align the flange with the sewage outlet and tighten the screws to fix it.

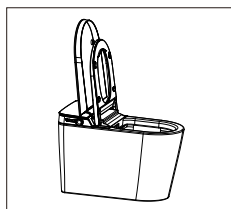

3. Lift the toilet lid and seat ring, hold the position under the cleaning nozzle with your hand and lift out the entire upper part of the toilet.

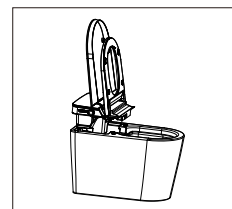

4. Loosen the electrical wires and braided hose attached to the top half of the toilet.

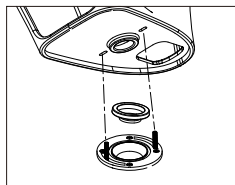

5. Put the flange sealing ring on the flange, and then align the mounting bolts through the mounting holes at the bottom of the toilet.

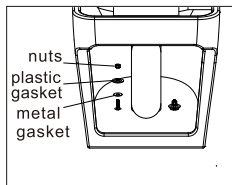

6. Put metal gaskets, plastic gaskets and nuts on the bolts in sequence, and then tighten the screws to fix them after the installation is stable. (Please process this installation from the top of the toilet bowl)

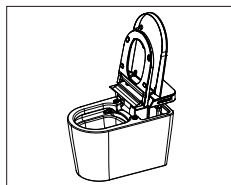

7. Following step 4, reconnect the electrical wires and braided hose.

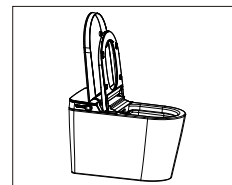



8. Align the upper half of the toilet with the ceramic and re-fasten with the ceramic.

2. Connect the water supply pipe

When the water supply valve is closed, remove the old angle valve and replace it with the machine-equipped angle valve. Please use the supply hose included. Do not use the old one.

⚠ Before installing the valve, please drain all the impurities and sewage in the pipes. (Discharge the water for 1 to 2 minutes)

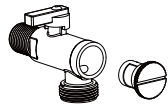
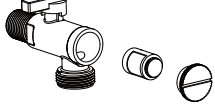
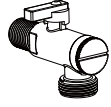
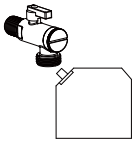
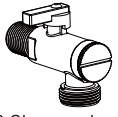

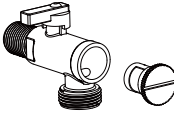
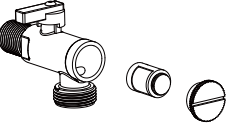
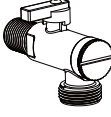
DO NOT UNPACK THIS UNIT OR DISCARD PACKAGING UNTIL YOU PERFORM THIS STEP!

 <p>1. Install provided shut off valve, close angle valve.</p>	 <p>2. Unscrew the front cap.</p>	 <p>3. Remove the mesh filter.</p>	 <p>4. Install the cap back.</p>
	<p>5. Turn on the angle valve switch. Fill the provided test bag from the installed valve. The bag must fill within 15 seconds to ensure the water volume is sufficient to operate the toilet and to clear the water line of any debris before installing the unit. If the bag doesn't fill completely, there's not enough volume for the toilet to function properly. If volume is low, check for any debris in the valve. If the valve is clear, please consult a plumbing professional for possible solutions.</p>		 <p>6. Close angle valve.</p>
 <p>7. Install provided shut off valve and flow restrictor if line pressure is above 20psi. Usually, the pressure will be over 20psi.</p>	 <p>8. Unscrew the front cap again.</p>	 <p>9. Install the mesh filter back.</p>	 <p>10. Install the cap and tighten.</p>

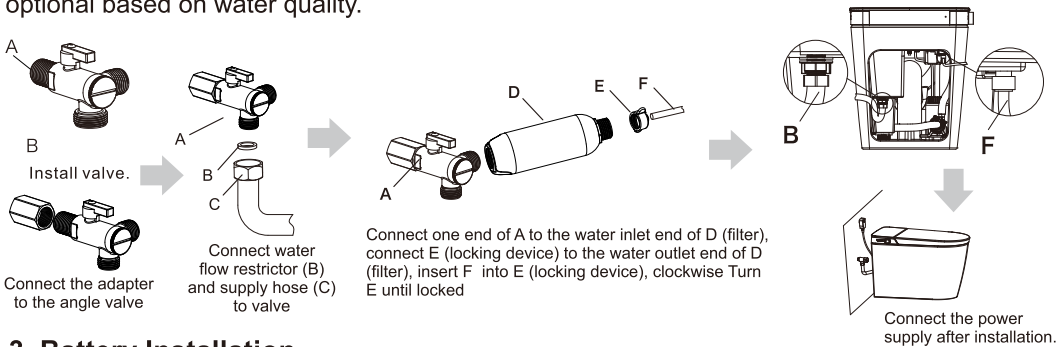
① Connect the supply line with inlet valve. ② After the machine is installed, open the knob to detect no leakage at A, B, C and E. ③ Inspection is correct, plug in the power supply, press the "manual flush" button to confirm the siphon effect of sewage. ④ Filter installation is optional based on water quality.

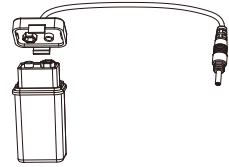
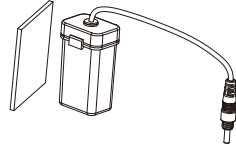
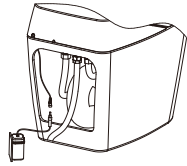

3. Battery Installation

 <p>① Open the battery box, and put in put one 9V battery inside .</p>	 <p>② Close the battery box, and put the sticker on one side of battery box.</p>	 <p>③ Connect the wire.</p>	 <p>④ Remove the label of sticker and fix the battery box to the ceramic toilet.</p>
---	---	--	--

Product cleaning and maintenance methods

Warning: waterproof toilet cleaning precautions

- Do not clean the product with your hands in case of damage or failure, to avoid secondary failure.
- Do not use hydrochloric acid detergent, thinner, bleach, benzene or strong detergent to clean the surface of the toilet. Do not allow pesticides, air fresheners and deodorants to stick to the toilet bowl.
- **The body discoloration, cracking and damage caused by the use of the above-mentioned reagents, even within the warranty period also need to paid the services.**

1. Nozzle cleaning

- ① On the machine power mode, do not sit on the seat.
- ② Press "Nozzle cleaning", entering the manual cleaning nozzle mode. (Can not activate "nozzle cleaning" mode when seated)
- ③ Please use soft brush or soft cloth when cleaning.
- ④ After the cleaning is completed, press the stop button or in the seating state, the cleaning tube is automatically retracted.
 - **Warning: do not force out or push into the cleaning tube during cleaning, or it may lead to machine failure.**

2. Filter cleaning

When the water supply valve is closed, cut off the machine water supply, do the following operation.

- ① Shut off inlet valve by clockwise rotation
- ② Unscrew water filter by a coin or slot screwdriver
- ③ Take out water filter and clean by toothbrush or other clensers. Mount water filter back after cleaning.
- ④ Turn on inlet valve by counterclockwise rotation

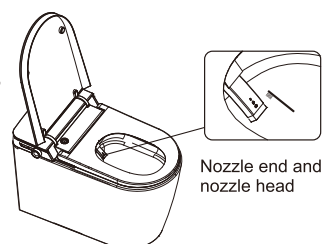
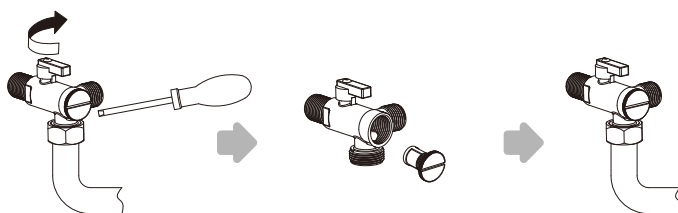

Toilet appearance cleaning method diagram

- ① Please unplug the power plug from the socket or press the reset button on the leak protection.
- ② Use a soft cloth or sponge stained with neutral detergent to clean the machine.
- ③ Wipe the whole machine with cotton cloth after cleaning.

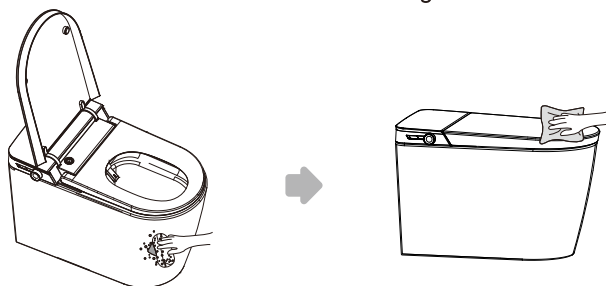

3. Seat toilet management methods in winter

In order to prevent freezing in winter, please follow the following methods to manage.

- ① Check whether the power plug is properly inserted into the socket.
- ② When the bathroom has no heating device, please use cloth to wrap connecting pipes or other insulating materials for insulation.

• **Note:**

Please tighten the filter firmly, otherwise it may cause water leakage.

Do not grab the filter net too strongly as it may distort or rupture.

When blockage blocks the filter, the pressure of the flushing water may not be enough, so please clean the toilet regularly once in three months.

We recommend that you do not use detergent when cleaning. Clean it directly with tap water.

How to deal with common problems

Problems		Check	Handling
Functions does not work at all.		The seat sensing area uses cloth cover, mat and other items.	Please remove the cloth cover, mat and other items.
		Power is cut.	Please wait for power recovery.
		Socket is loose or poor contact.	Plug in, ensure good power supply.
		Whether the leakage protection reset button is pressed.	Please press the reset button on the leak protection.
Flushing	Water doesn't come out.	No water.	Please wait for the water supply to resume.
		Whether the inlet valve is open.	Open the inlet valve.
		Whether the filter screen clogged with dirt	Please clean the filter
		Whether the water supply tube is bent and clogged.	Eliminate the water supply pipe bending.
	Flushing power is not strong enough.	Water pressure is set at low-grade.	Turn the water pressure up to high.
		Whether the filter screen clogged with dirt	Please clean the filter
		Clean the nozzle to see if there is any blockage.	Please clean the nozzle.
	Water temperature is not high enough.	Whether the water temperature is set at low or normal temperature.	Turn the water temperature up to high.
	No water supply when flushing.	Press the "Rear Wash" or "Front Wash" key for about 60s, the machine will automatically stop.	Please restart cleaning.
		The body is removed from the seat during the cleaning process.	Please sit back in the seat circle and restart cleaning.
Toilet Seat	The heated seat is not heating.	Thermal seat's heating strength is set in the low or off state.	Turn the seat temperature up to high.
		The toilet is set in the energy-saving state.	Please exit energy-saving state.
	Whether the power outage.	Please wait for power recovery.	

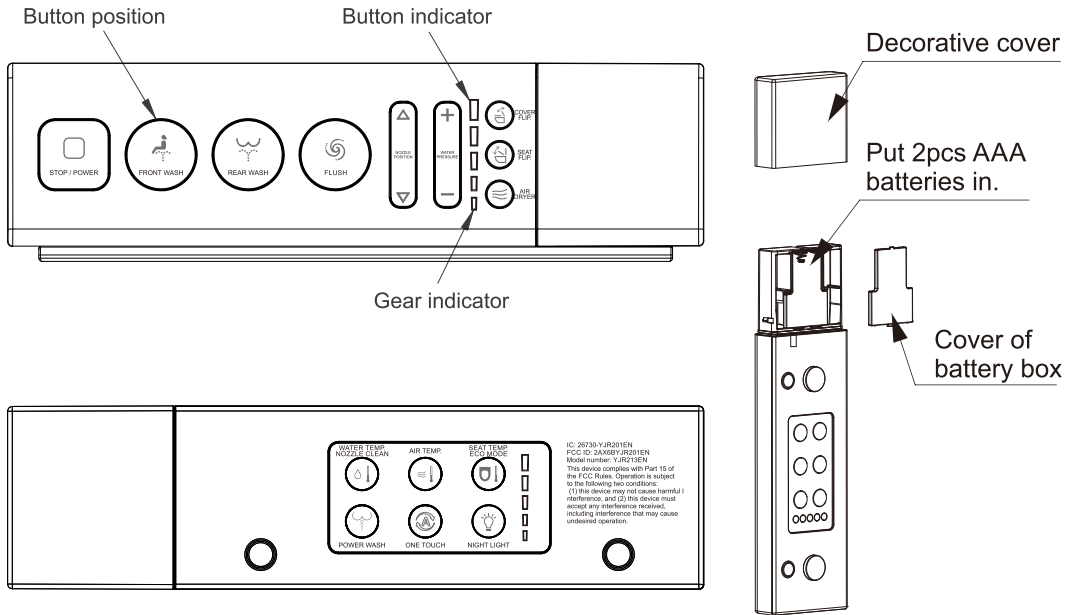

Remote control user manual



Remote control code matching steps:

1. Turn off the smart toilet
2. Press and hold the STOP/POWER button and AIR DRYER button on the remote control simultaneously for 3 seconds, until the 5 indicators are turned on and flashing;
3. Turn on the smart toilet;
4. If all the 5 indicators on the remote control turns on , it means code matching succeeded , if not successful , please try the above steps again after 15 seconds.

1. Main function

<p> Rear Wash short press: start rear wash, short press again : start /stop moving wash.</p> <p> Front Wash short press: start front wash, short press again: start/stop moving clean.</p>	<p><input type="checkbox"/> Stop/power In washing state , short press to stop current cleaning mode. While off seat , long press: enter to standby mode.</p> <p> Flush Short press to flush once.</p>
--	--

2. Parameter adjustment

<p>+</p> Adjust water pressure Short press "+", water pressure grade +1, short press "-", water pressure grade -1. <p>△</p> Adjust tube front and rear position. Short press "△", tube position grade +1, short press "▽", tube position grade -1.	<p>🪸</p> Adjust seat temperature short press: cyclically adjust seat temperature Long press : enter/ exit energy saving mode. <p>💧</p> Adjust water temperature short press: cyclically adjust water temperature Long press: start nozzle clean. <p>☁️</p> Adjust air temperature Short press: cyclically adjust air drying temperature.
--	--

3. Auxiliary functions

<p>🔄</p> One-touch completes rear wash and warm air drying. Short press: start automatic "One Touch" mode. <p>🪸</p> Seat Flip Short press to open or close the seat. <p>🪸</p> Cover Flip Short press to open or close the cover.	<p>🪸</p> Power wash short press :start power wash. <p>☁️</p> Warm air drying Short press :start warm air drying. <p>💡</p> Night light short press:turn on /off night light.
---	--

4. Others

Energy saving

After the user leaves the seat, intelligently adjust the heating power of the seat.

Remote control installation steps

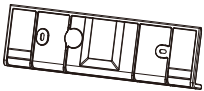
- ① 

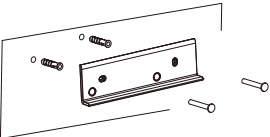
remove 3M protective film
- ② 

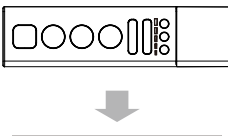
A. Determine the screw position.
B. Put the expansion nut.
C. Remove the sticker on the back
of the remote control holder, Stick
it to the right place on the wall.
D. Screw on.
- ③ 

Insert the remote
control into the holder
- ④ 

Completed

Battery quantity of remote control

2pcs AAA Batteries.

Thank you for choosing us

The company is committed to product development and improvement. If there is any difference between the original manual and the improved one, please read the corresponding version of the manual. We apologize for any inconvenience.

尺寸：18.3x25.7cm

材质：封面和内页材质：80g双胶纸

装订工艺：骑马钉