

# User manual

AP301 series Smart Air Purifier

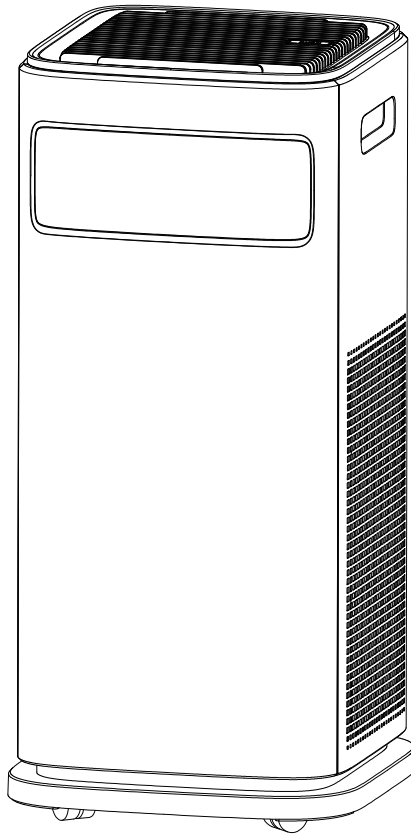

## **READ AND SAVE THESE INSTRUCTIONS**

Thank you for using our products. Please read this manual carefully before using our products!

This product can only be used in family or similar places.

# 1. Safety precautions

---

In order to avoid possible injury or financial loss to you or others, please pay attention to the following safety precautions.

If the power cord is damaged, in order to avoid danger, it must be repaired by the professional personnel of the manufacture.



## Warning



**Do not touch the power plug with wet hands.**

Otherwise, electric shock may be caused.



**Before cleaning the electrical apparatus, make sure that the power supply has been disconnected.**

Before cleaning the electrical apparatus, make sure that the power supply has been disconnected.



**Do not use universal socket or equipment beyond the specified value, it may cause overheating or fire accidents.**



**Please insert the plug into the power socket before starting the air purifier.**

If the plug is not fully inserted into the socket, it may cause electric shock and overheating, and even cause fire accident.

- Do not use damaged plugs or loose power outlets.



**Do not damage the power cord and socket.**

When using the machine, do not bind the wires. Using the damaged wires may lead to electric shock, short circuit or fire accident.

- It is forbidden to cut, refit, over twist, twist, poke and pull wires, or place heavy objects on wires or sockets.



**Please clean the power plug regularly.**

If dust accumulates on the power plug, the insulation part of the plug may be damaged, resulting in a fire accident.

- Pull out the power plug and clean it with a dry cloth (do not use a wet cloth!).
- If the appliance is not used for a long time, the power plug should be removed.



**It is forbidden to disassemble or refit the air purifier without authorization.**

Unauthorized disassembly or modification of electrical appliances may lead to electric shock, failure or fire accident.

This appliance has a polarized plug (one blade is wider than the other). To reduce the risk of electric shock, this plug is intended to fit in a polarized outlet only one way.

If the plug does not fit fully in the outlet, reverse the plug.

If it still does not fit, contact a qualified electrician. Do not attempt to defeat this safety.

**WARNING:** To Reduce The Risk Of Fire Or Electric Shock, Do Not Use This Fan With Any Solid-State Speed Control Device.

**WARNING:** To Reduce The Risk Of Fire, Electric Shock Or Injury To Persons, Do Not Use Replacement Parts That Have Not Been Recommended By The Manufacturer (e.g. Parts Made At Home Using A 3D Printer).

**RISK OF ELECTRIC SHOCK** – These servicing instructions are for use by qualified personnel only.

To reduce the risk of electric shock, do not perform any servicing other than that contained in the operating instructions unless you are qualified to do so.

This product complies with the maximum allowable concentration of ozone of 0.050 parts per million by volume (ppmv) in a 24-h period.



## Warning



It is forbidden to use benzene or thinner and other solvents to clean the air purifier, so as to avoid contact with insecticide sprays.

Otherwise, the air purifier may break and cause damage, even short circuit, resulting in electric shock or fire accident.



Pull out the power plug, **please hold the plug, please not pull the wire.**

If the wire is pulled directly, it may cause short circuit, or damage the wire, leading to fire or electric shock.



It is forbidden to use this air purifier in places with greasy particles.

For example, in the kitchen, the air purifier may break and cause damage.

- The air purifier shall not be used as ventilation or air extraction equipment.



It is forbidden to use this air purifier in places with high temperature, humidity or wet body, such as bathroom.

The air purifier may leak electricity and cause electric shock or fire accident.



It is forbidden to use the air purifier in the room with fumigation insecticides.

Chemical residues may accumulate in the unit and then be released from the air outlet, thus endangering health.

- After using insecticide, the room should be thoroughly ventilated before using the air purifier.



Do not let volatile substances or combustible materials, such as tobacco or sparks, float into the aircraft.

Otherwise, fire accidents may occur.



Do not wet the fuselage.

Otherwise, electric shock and fire accidents may occur due to short circuit.

## ⚡ Warning

- If you need to move the product, please disconnect the power of the product first.
- Be sure to move the product slowly.
- Do not move the product by pulling the power cord.
- Do not move the machine while the product is in operation. If you need to move the machine, please turn off the power.

## ⚡ Warning

**In case of any of the following conditions, please turn off the power of the machine immediately.**

- If the circuit breaker works or the fuse burns out.
- If the power cord or plug is abnormally hot.
- If you find a burnt odor or abnormal sound or vibration.
- If there is any other abnormal phenomenon or fault.

## 2.Product introduction

---

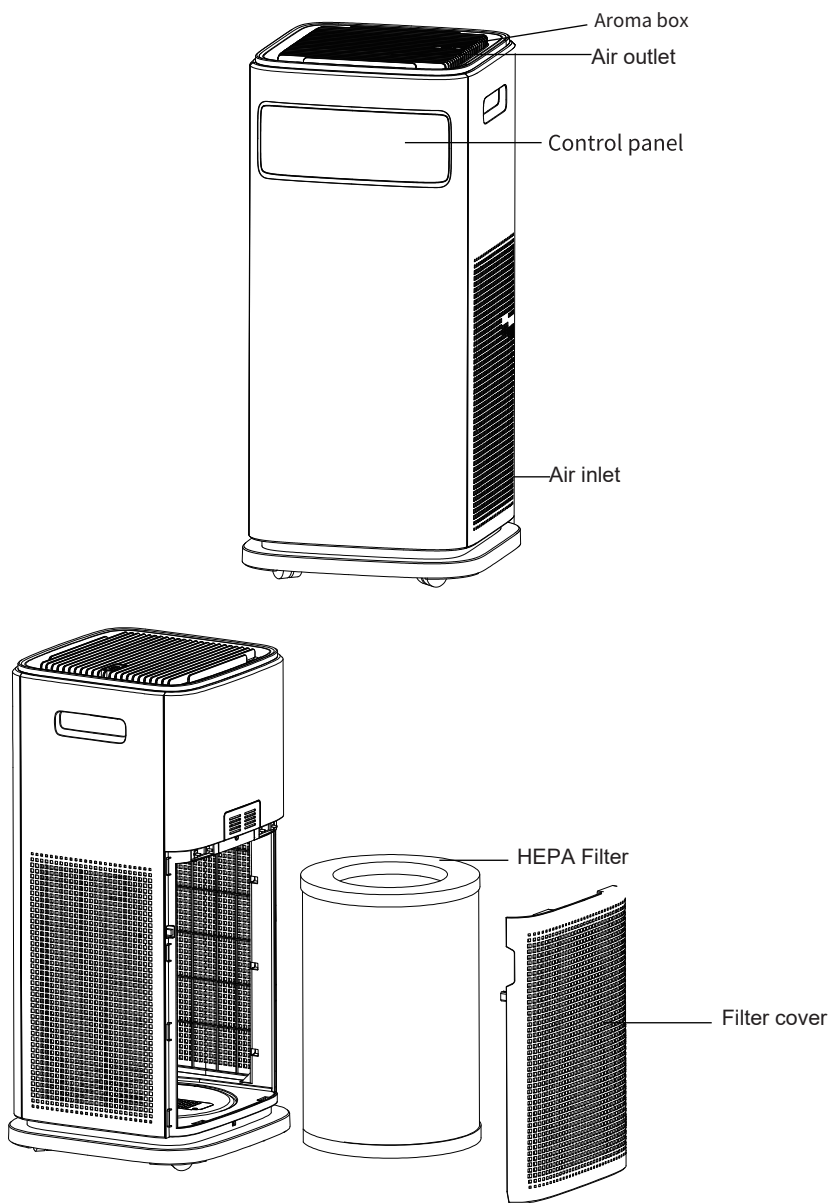

If there is any difference between the product picture and the real object, the real object shall prevail.

## Package list

1 x Air Purifier  
1 x HEPA Filter(Pre-Installed)  
1x User Manual

## Specifications

Model	AP301AW
Dimension	31.6x31.6x68.3cm 12.4x12.4x26.9in
Net weight	16.5lb/7.5kg
Rated Voltage	100-240V
Rated frequency	50/60Hz
Rated Power	53W
Wi-Fi	Support

## Install the filter

### Information

This air purifier is equipped with a filter inside, but before using the product, be sure to remove the packaging of the filter. Please follow the instructions below to remove the filter and its package, and then put it back into the purifier.

### ⚡ Warning

- Do not operate the machine without filter.
- Remove the plastic packaging of the filter before use.

## Getting started

When using the air purifier for the first time, please follow the steps below to install the filter correctly.

- 1) Remove all packaging materials and place the machine on a dry, stable, flat surface.

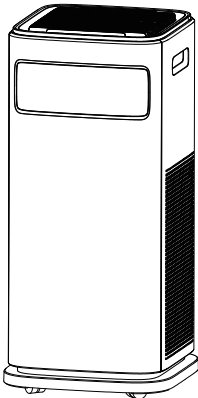

- 2) Press the upper right side of the filter cover with your right hand, and pull out the cover with your left hand in the direction of the arrow from the side gap.

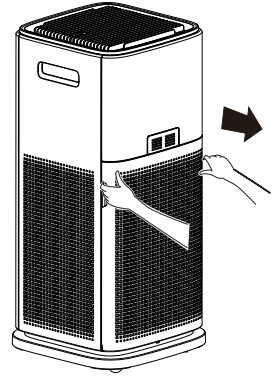

- 3) Take out the HEPA filter from air purifier.

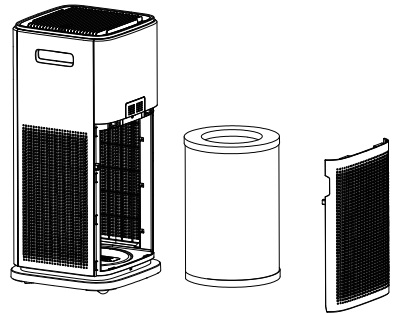

- 4) Remove the packing material from HEPA filter.

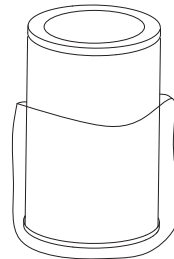

5) Replace the filter cover. The air purifier will not power on unless the filter cover is replaced correctly.

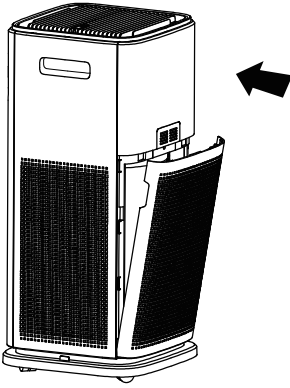

6) In order to achieve good air circulation effect in your room, make sure that the air inlet and outlet of the machine are not less than 50 cm away from the obstacles.

Please use at least 1m away from TV, radio and other electrical appliances.

Please do not plug the power plug into the same socket as the power plug of TV, radio and other electrical appliances.

#### 💬 Tips

- Do not obstruct the air inlet and outlet to ensure adequate ventilation and maximum efficiency of the machine.
- Place the machine in a dry location on a smooth and flat floor.

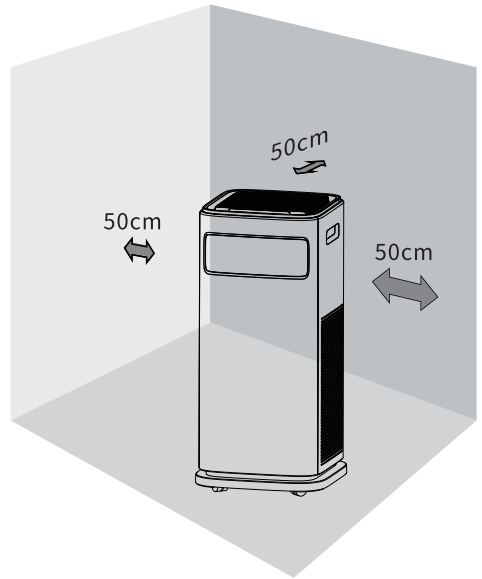

## How the air purifier works?

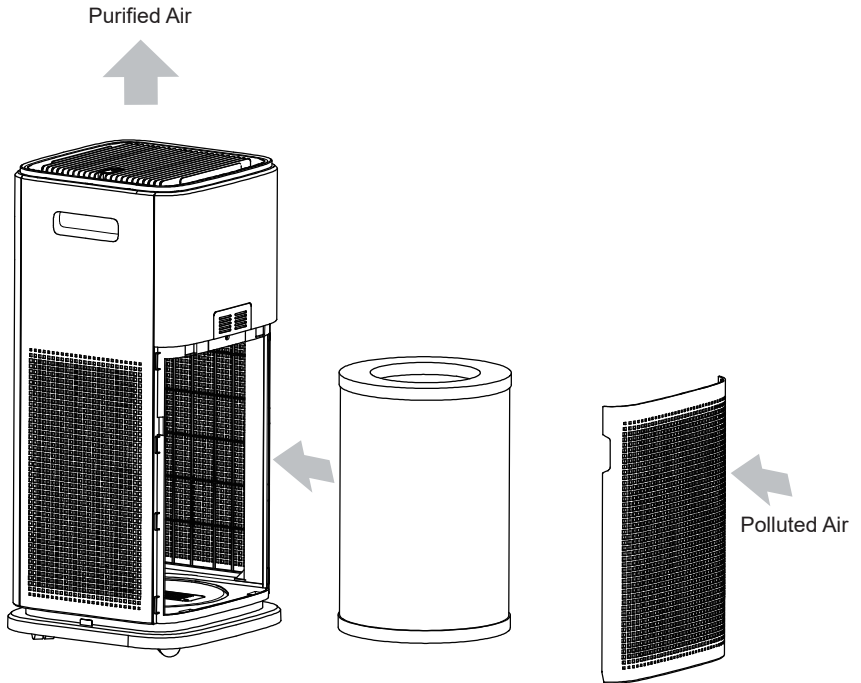

The picture is for reference only. If there is any difference between the real object and the picture, the real object shall prevail. Our company reserves the right to explain.

## 3.Control Panel

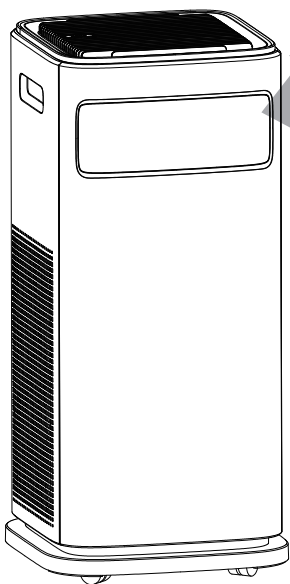
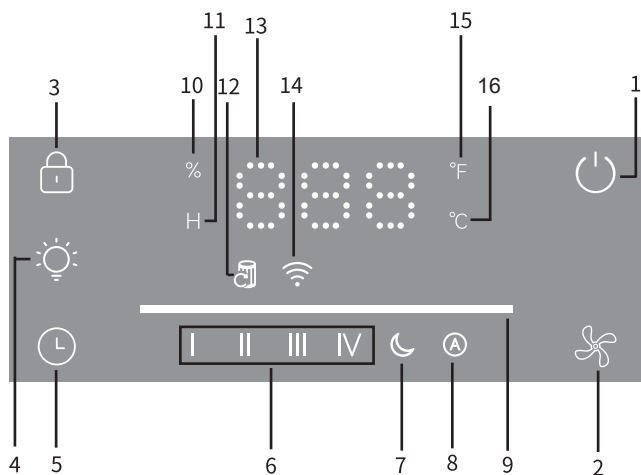

- |                                |  |
|--------------------------------|--|
| <b>1</b> Power On/Off button   | <b>9</b> Air quality indicator             |
| <b>2</b> Fan speed button      | <b>10</b> Humidity indicator               |
| <b>3</b> Child lock button     | <b>11</b> Timer indicator                  |
| <b>4</b> Display On/Off button | <b>12</b> Check filter indicator           |
| <b>5</b> Timer setting button  | <b>13</b> Digital display area             |
| <b>6</b> Fan speed indicators  | <b>14</b> WIFI indicator                   |
| <b>7</b> Sleep mode indicator  | <b>15</b> Fahrenheit temperature indicator |
| <b>8</b> Auto mode indicator   | <b>16</b> Celsius temperature indicator    |

## 4. Start to use your air purifier

### General Operation

1. Plug in and the buzzer will sound once, the air quality indicator will change color by red-orange-yellow-green-blue, the machine will enter standby mode.

2. Press power ON/OFF button to turn the air purifier on. The fan will start automatically.

3. Optionall, press FAN speed button to change FAN speed from Level-I to Level IV. You can also select Sleep mode or Auto mode by press this button.

#### Tips

- For best experience, please run the air purifier at high speed around 20minutes before select lower speed or sleep mode.
- To clean air effectively, please keep window or door closed while the air purifier is operating.

### Sleep mode

Sleep mode use the lowest fan speed to create a quiet environment.

Press FAN speed button to select Sleep mode. Keep press FAN speed button again will exist Sleep mode.

### Auto mode

Auto mode use the dust sensor inside the air purifier to adjust the fan speed automatically.

Press FAN speed button to select Auto mode. Keep press FAN speed button again will exist Auto mode.

### Air Quality Indicator

Depend on the air quality detected by the dust sensor, the Air quality indicator will change color.

Indicator color	Air quality
 Blue	Very good
 Green	Good
 Yellow	Moderate
 Orange	Bad
 Red	Very bad

### Child lock



Press the child lock button for 3 second, the buzzer will sound, and the child indicator will light up which means the function is opened. All button are invaild except the child lock button.

Press the child lock for 3 second again will exist child lock.

## Use the Aroma box

Your Air Purifier can be used for aromatherapy.

1. Push the aroma box at the top of the outlet and pull it out.

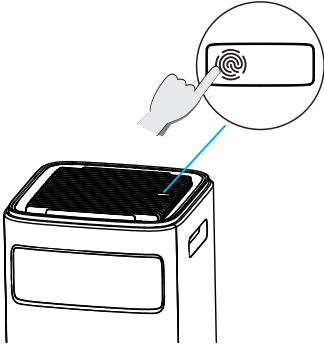

2. Put 8-10 drops of essential oil on the cotton pad or put essential oil mat on the aroma box.

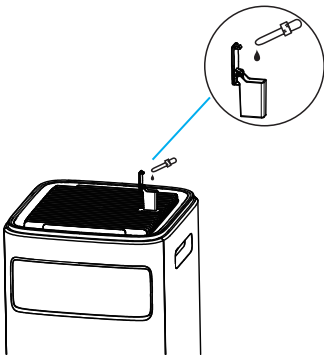

3. Place the aroma box back to the Air Purifier. The Air Purifier will automatically diffuse aroma .

### Tips

- The aroma is intended to be slightly, this Air Purifier is not an aroma diffuser.
- The essential oil or essential oil mat is not supplied with the Air Purifier and needs to be purchased separately by user.

## Timer

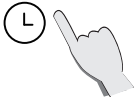

You can set timer for 1,2,4,6,8,10 or 12 hours. Press timer button to cycle timer options and turn the timer off.After you set timer,it will start timer program automatically. Once the timer ended, the air purifier will turn off.

## Tips

- While timer is on, the fan speed still could be set.
- The timer will be reset when the time is changed.
- Press the power on/off button or unplug the power supply, the timer setting will be canceled.

## Display On/Off

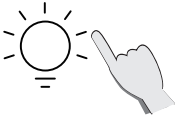

Press the button to turns off the display. When display off,press any button could turn on the display.

## Smart Life App setup

1. Search for **Smart Life** in Apple's App Store and Google Play Store, or scan the QR code to download the Smart Life App.
2. Open the Smart Life App, if you already have an account, tap **Quick Login**. To create a new account, tap **Log in with Password** -> **Register** to register.
3. Follow the in-app instructions to set up your Air Purifier.
4. Wi-Fi Connection:
  - Long press timer setting button for 3 seconds, the Wi-Fi will enter the EZ(Easy connect) mode, the Wi-Fi indicator will quickly blink, follow the in-app instructions to connect your Air Purifier.
  - In EZ mode, press timer button for 3 seconds again, Wi-Fi will slowly blink to enter AP(Access point) mode, you also could follow the in-app instructions to connect your Air Purifier.
  - After connected, the Wi-Fi indicator will stop blinking to steady on.



# 5.Maintenance

## Cleaning the Air Purifier

1. Unplug before clean the Air Purifier.
2. Clean the outside of the Air Purifier body with a soft and dry cloth.
3. Also clean the inlet or outlet with a soft and dry cloth.

### **Note:**

**Do not** clean with abrasive chemicals or flammable cleaning agents.

**Do not** wash the HEPA filter.

## Reset the Filter Indicator

Rest the Filter Indicator when light up.

1. Unplug the air purifier and remove the filter cover.

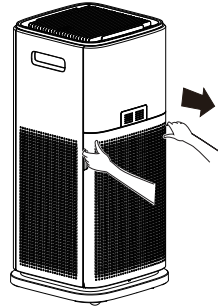

## Check Filter Indicator

Filter indicator  will light up as a reminder to check the filter. The indicator should light up within 4-6 months. You may need to replace your filter sooner or later which depending on how often you use your Air Purifier. Use in high pollution environment may need to replace the filter more often, even filter indicator is off.

2. Remove the old filter and clean out any remaining dust inside the air purifier by use a vacuum hose. **Do not** use water or Liquids to clean the air purifier.

### Tips

- You may need to replace your filter when notice
- Noise increased when air purifier is running
  - Airflow decreased
  - Unusual smell appears
  - Filter blocked visibly

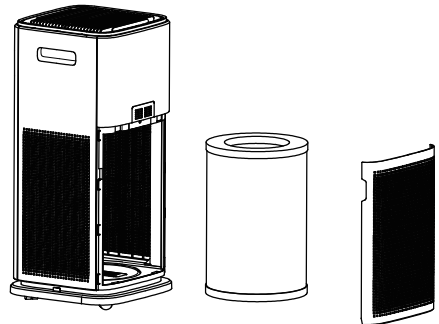

## Reset the Filter Indicator

3. Remove packing material from the new filter.

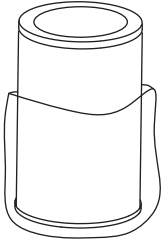

6. Plug in and turn on the air purifier. Reset the filter indicator by press and hold Timer button for 5seconds.

### Tips

If not use the air purifier for a long period of time, wrap the filter in plastic packaging and store in a dry place to avoid moisture admage.

4. Put the new filter back into the filter.

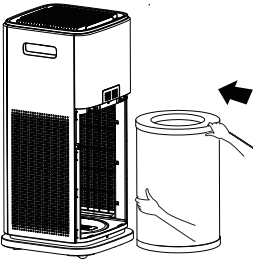

5. Replace the filter cover. The air purifier will not power on unless the cover is replaced correctly.

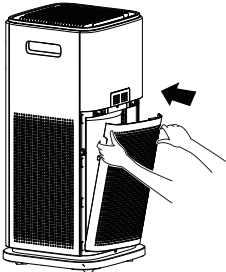

## 5. Troubleshooting

Problem	Possible Solution
Air Purifier can not be turn on.	Plug the power cord.
	Check the power cord is damaged. If yes, please stop to use the air purifier and contact after-sales service.
	Air purifier is malfunctioning. Please contact after-sales service.
FAN not work or make an unusual noise	Check the package is removed from filter.
	Air purifier may be damaged or have a foreign object inside. Stop using the air purifier and contact after-sales for service.
Purification significantly reduced	Make sure package is removed from filter and filter is properly placed in air purifier.
	Make sure the air purifier is at least 50cm away from obstacles.
	Press fan speed button to increase the airflow.
	The filter may be blocked by large particles, please clean the filter.
	Replace the filter.
Strange smells from air purifier	Clean the filter or replace the filter if necessary.
	Do not use air purifier in high humidity area.
Filter indicator still on after replaced filter	Please follow page 14 to reset the filter indicator.
Filter indicator not turned on within 6 months	It depends on how long the air purifier has been used. If you don't use the air purifier often, the filter indicator will take longer to turn on.

If your problem is not listed, please contact After-sales for support. (page 16).

## 6.Warranty and Service

---

1.If,within 7 days after purchase,any quality problem is found,you can choose to return or replace the product.Please contact your dealer for assistance.

2.If,within one month after purchase,any quality problem is found,please contact your dealer to help troubleshoot the problem.You can choose after-sales repair or replacement.

3.If,within one year after purchase,any quality problem is found,please contact your dealer to help troubleshoot the problem and obtain after-sales repair service.

Email:support@sejoy.com  
Made in China

## 7.Other information

---

### Recycling



When discarding products, please do not stack them with general domestic waste. Please understand the local regulations on classifying mobile phone electronic or electrical products.

Proper disposal of the product helps to avoid potential negative effects on the environment and human health.