



# Underscore® Rectangle

## 5' VibrAcoustic® Bath

### K-1167-VBCW



#### Features

- End drain.
- Slotted overflow for deep soaking.
- VibrAcoustic® technology emits sound waves and offers a surround sound experience.
- Six transducers and a control amplifier with 25' (7.6 m) of wiring.
- High-resolution color screen in polished chrome.
- Chromatherapy lighting allows you to select a preferred color scheme to suit your mood.
- Bask® heated surface creates spa-like relaxation with soothing warmth on your back, shoulders, and neck.
- Integral lumbar support.
- 60" (1524 mm) x 30" (762 mm) x 19" (483 mm)

#### Material

- Acrylic

#### Installation

- Drop-in or under-mount.
- Syncs with devices enabled with BLUETOOTH® wireless technology including smart phones, MP3 players, tablets and laptops located up to 33 feet away.\*

#### Required Accessories

K-7271 Brass Slotted Overflow Bath Drain

or

K-7272 PVC Slotted Overflow Bath Drain

#### Recommended Accessories

1184460 Under-Mount Installation Kit

K-1491 Bath/Whirlpool Pillow

K-1601 Bath/Whirlpool Footstop

K-531 Under-Mount Installation Kit

K-1177 Vinyl Tiling-in Bead



ADA

#### Codes/Standards

CSA B45.5/IAPMO Z124

ASTM E162

ASTM E662

UL 1795

CSA C22.2 No. 218.2

Greenguard UL 2818 - Gold

ADA

ICC/ANSI A117.1

#### KOHLER® Plastic Baths and Receptors Lifetime Limited Warranty







See website for detailed warranty information.

\*The BLUETOOTH® word mark and logos are registered trademarks owned by Bluetooth SIG, Inc. and any use of such marks by Kohler Co. is under license. Other trademarks and trade names are those of their respective owners.

#### Available Color/Finishes

*Color tiles intended for reference only.*

**Color Code Description**

	0	White
	96	Biscuit
	47	Almond
	NY	Dune
	95	Ice™ Grey
	G9	Sandbar
	K4	Cashmere

1-800-4KOHLER (1-800-456-4537)

Kohler Co. reserves the right to make revisions without notice to product specifications.

For the most current Specification Sheet, go to [www.kohler.com](http://www.kohler.com).

10-5-2018 08:45

THE BOLD LOOK  
OF **KOHLER**®

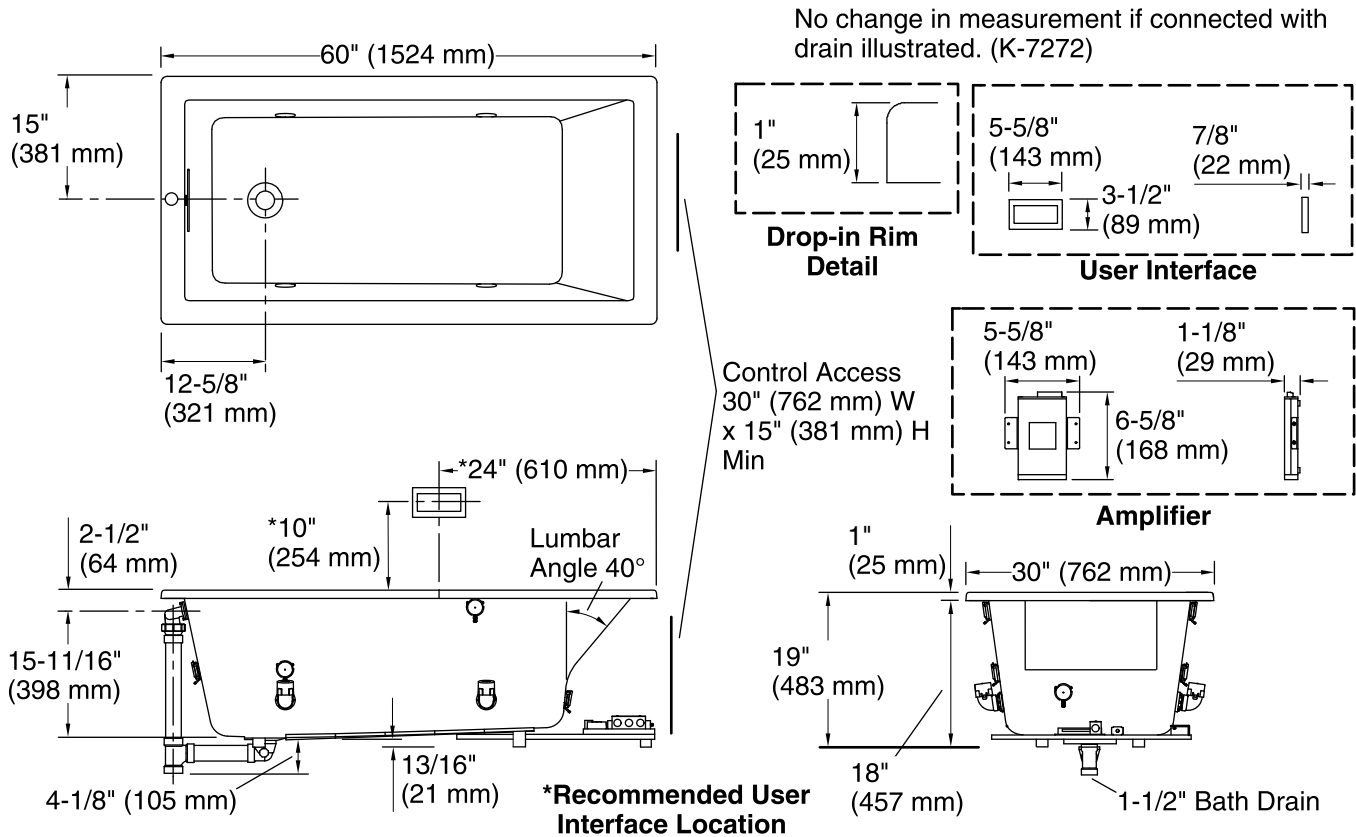

No change in measurement if connected with drain illustrated. (K-7272)

### Required Electrical Service

One circuit required, protected with Class A Ground-Fault Circuit-Interrupter (GFCI) or Residual Current Device (RCD).

Amplifier, Heated Surface: 120 V, 15 A, 50/60 Hz

### Technical Information

All product dimensions are nominal.

Installation:	Drop-in, Under-mount, Drop-in, Under-mount
Drain location:	End
Basin area, bottom:	42-3/8" x 20" (1076 mm x 508 mm)
Basin area, top:	54-3/8" x 24-5/16" (1381 mm x 618 mm)
Weight:	80 lbs (36.3 kg)
Minimum floor load:	50 lbs/ft <sup>2</sup> (244.1 kg/m <sup>2</sup> )
Water depth:	15-1/16" (383 mm)
Water capacity:	59.8 gal (226.4 L)
Cutout:	Drop-in, 59-1/2" x 28-1/2" (1511 mm x 724 mm)
Electrical component rating:	Amplifier: 120 V, 1.1 A, 50/60 Hz Heated Surface: 120 V, 0.5 A, 50/60 Hz, 65 W

### Notes

Measure your actual product for rough-in details. Install this product according to the installation instructions.

The hot water supply should be 70% of the capacity of the bath or greater. Installations will vary.

Control amplifier fits 16" (406 mm) center studs. 25' (7.6 m) cables are included.

ADA compliant when installed to the specific requirements of these regulations.