









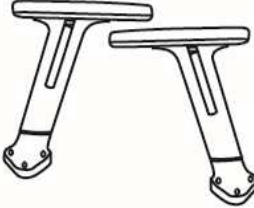

MODEL: B6716 B6716-SS

(1)x1  Back Cushion	(2)x1  Seat Cushion & Mechanism	(3)x1 (L)x1 (R)  Left-Arm Right-Arm
(4)x 5  Caster	(5)x1  Gas Lift W/ Cover	(6)x1  Base
(A)*2   M6*30 Arm Screws	(B)*4   M6*40 Arm Screws	(C)*3  M8*18 Back Bar Screws

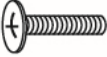

Insert and loosely tighten all screws. When assembly is completed, fully tighten all screws before using. This chair is only intended for sitting. Any other use will void the warranty.

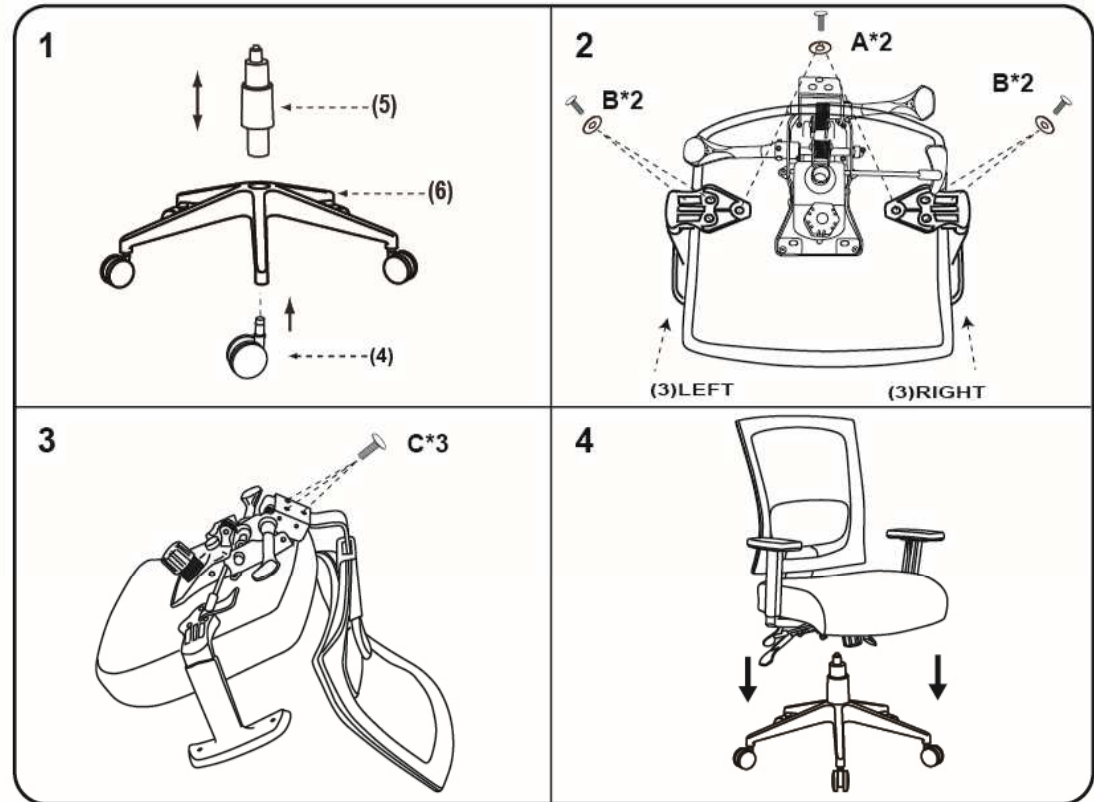