

Galanz

Model# GLDW09TS2A5A
Dishwasher User Manual



Thank you for purchasing a Galanz product. Please read this manual carefully for correct usage and safety, and keep for future reference. For service, support and warranty information, call 800-562-0738.

@2019 Galanz Americas Limited Company.

CONTENT

CONTENT

Important Safety instructions	2
Dishwasher Components	4
Product Diagram	5
Dishwasher Setup	6
Dishware Materials	12
Loading the Dishwasher	13
Dishwasher Cycles and Options	17
Wash Cycle information	18
Operating the Dishwasher	19
Maintenance and cleaning	21
Troubleshooting Tips	23

IMPORTANT SAFETY INSTRUCTIONS

WARNING

- Misuse of the dishwasher can result in serious injury or death. Do not use the dishwasher in any way not covered in this manual or for any purpose other than those explained in the following pages.
- Severe product damage and/or injury could result from the use of unqualified service technicians or non-original replacement parts. All repairs must be performed by a qualified service technician using only original equipment factory replacement parts.
- Electrical shock or fire could result if the electrical supply for the dishwasher covered in this manual is incorrectly installed or if the dishwasher has been improperly grounded. Do not use the dishwasher covered in this manual unless you are certain the electrical supply has been correctly installed and the dishwasher has been properly grounded.
- Never use harsh chemicals to clean your dishwasher. Some chloride-containing products can damage your dishwasher and may present health hazards!

NOTICE

- Never use steam cleaning products to clean your dishwasher. The manufacturer will not be responsible for the possible damages or consequences.
- To avoid possible dishwasher damage, do not use harsh chemicals, abrasive cleaners, scouring pads (metal or

plastic), or abrasive cloths/paper towels to clean your dishwasher's exterior door panel. Your dishwasher's exterior door panel can be damaged by doing so.

- NSF/ANSI 184 Certified residential dishwashers are not intended for licensed food establishments

WARNING: To reduce the risk of fire, electrical shock, or serious injury, observe the following

This dishwasher is provided with Installation Instructions and this Use and Care Manual. Read and understand all instructions before using the dishwasher.

When using your dishwasher, follow basic precautions, including the following:

- Read all instructions before using the dishwasher.
- Use the dishwasher only for its intended function.
- Use only detergents or rinse aids recommended for use in a dishwasher and keep them out of the reach of children.
- When loading items to be washed:
 - 1) Locate sharp items so that they are not likely to damage the door seal; and
 - 2) Load sharp knives with the handles up to reduce the risk of cut-type injuries.
- Do not wash plastic items unless they are marked "dishwasher safe" or the equivalent. For plastic items not so marked, check the manufacturer's recommendations.

SAVE THESE INSTRUCTIONS

IMPORTANT SAFETY INSTRUCTIONS

IMPORTANT SAFETY INSTRUCTIONS

WARNING

- Do not touch the heating element during or immediately after use.
- Do not operate your dishwasher unless all enclosure panels are properly in place.
- Do not tamper with controls.
- Do not abuse, sit on, or stand on the door or dish rack of the dishwasher.
- To reduce the risk of injury, do not allow children to play in or on a dishwasher.
- Under certain conditions, hydrogen gas may be produced in a hot-water system that has not been used for two weeks or more. HYDROGEN GAS IS EXPLOSIVE. If the hot-water system has not been used for such a period, before using the dishwasher turn on all hot-water faucets and let the water flow from each for several minutes. This will release any accumulated hydrogen gas. As the gas is flammable, do not smoke or use an open flame during this time.
- Remove the door to the washing compartment when removing an old dishwasher from service or discarding it.

- To avoid floor damage and possible mold growth, do not allow wet areas to remain around or under the dishwasher.
- Protect your dishwasher from the elements. Protect against freezing to avoid possible damage to the fill valve.
- Damage caused by freezing is not covered by the warranty.

- **WARNING:** To reduce the risk of electric shock, fire, or injury to persons, the installer must ensure that the dishwasher is completely enclosed at the time of installation.
- A hose that attaches to a sink spray can burst if it is installed on the same water line as the dishwasher. If your sink has one, it is recommended that the hose be disconnected and the hole plugged.

This appliance must be grounded. In the event of a malfunction or breakdown, grounding will reduce the risk of electric shock by providing a path of least resistance for electric current. This appliance is equipped with a cord having an equipment-grounding conductor and a grounding plug. The plug must be plugged into an appropriate outlet that is installed and grounded in accordance with all local codes and ordinances.

WARNING – Improper connection of the equipment-grounding conductor can result in a risk of electric shock. Check with a qualified electrician or service representative if you are in doubt whether the appliance is properly grounded. Do not modify the plug provided with the appliance, if it will not fit the outlet, have a proper outlet installed by a qualified electrician.

State of California Proposition 65 Warnings:

WARNING: This product contains one or more chemicals known to the State of California to cause cancer, birth defects, or other reproductive harm.

SAVE THESE INSTRUCTIONS

DISHWASHER COMPONENTS

Model	Heavy	Normal	Delicate	Light	Express	Rinse
-------	-------	--------	----------	-------	---------	-------

GLDW09TS2A5A ● ● ● ● ● ●

Additional Features	Description
Time Remaining Indicator	Indicates the cycle time remaining.
49dBA Sound Level	Quiet washing.
Delay Start	Start of a cycle can be delayed in 1-hour increments up to 24 hours.
Rinse Cycle	If you need to pre-rinse dishes to avoid odors, let the dishwasher do the work for you. Place unrinsed dishes inside dishwasher and select the "Rinse" cycle. Uses less water than hand rinsing and very low energy. Note: Do not use detergent in this cycle.
Plastic Item Clips	Securely holds light-weight plastic accessories(cups,lids,etc.).
Low Salt NotificationLight	Illuminates to indicate Salt is low.
Low Rinse Aid Notification Light	Illuminates to indicate Rinse Aid is low.
Energy Efficient 255kWh	ENERGY STAR qualified.

PRODUCT DIAGRAM

PRODUCT DIAGRAM

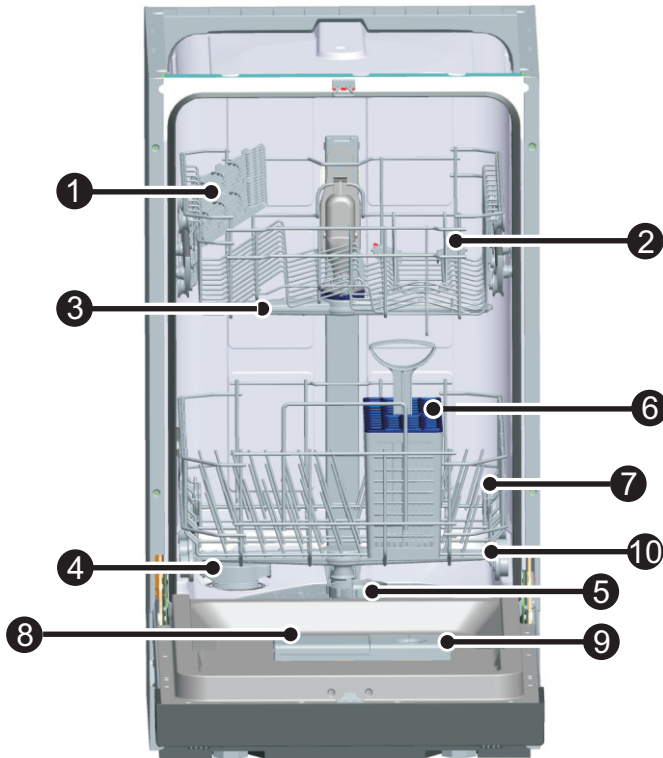

- ① Cup Shelf
- ② Upper rack
- ③ Top rack Spray Arms
- ④ Water Softener
- ⑤ Filters
- ⑥ Cutlery Basket
- ⑦ Lower rack
- ⑧ Detergent dispenser
- ⑨ Rinse Aid Dispenser
- ⑩ Lower rack Spray Arms

DISHWASHER SETUP

Before using your dishwasher for the first time:

- A. Set the water softener
- B. Pour 500ml of water inside the salt container and then fill with dishwasher salt
- C. Fill the rinse aid dispenser

A. Water softener

The water softener is designed to remove minerals from the water, which would have a detrimental or adverse effect on the operation of the appliance. The higher the content of these minerals and salts, the harder the water is. The softener should be adjusted according to the hardness of the water in your area. Your local Water Authority can advise you on the hardness of the water in your area.

Setting

The amount of salt dispensed can be set from H0 to H7. Salt is not required at the set value H0.

1. Find out about the hardness value of your tap water. Your water utility company will help you with this.
2. Set value can be found in the water hardness table.
3. Close the door.
4. Switch on "Power" switch.
5. Hold down "Delay" button and then press "Program" button for 5 seconds. The buzzer rings one time and H. . flashes on the digital display. (factory setting is H0)

To change the setting:

1. Press " Delay " button.
Each time the button is pressed, the set value increases by one level; when the value of H7 has been reached, the display jumps back to H0(off).
2. Press " Program " button. The chosen setting has now been stored. Contact your local water board for information on the hardness of your water supply.

Water hardness table

Water hardness		Mmol/l	Set value on the machine
°Clark	Range		
0-8	soft	0-1.1	H0
9-10	soft	1.2-1.4	H1
11-12	medium	1.5-1.8	H2
13-15	medium	1.9-2.1	H3
16-20	medium	2.2-2.9	H4
21-26	hard	3.0-3.7	H5
27-38	hard	3.8-5.4	H6
39-62	hard	5.5-8.9	H7

DISHWASHER SETUP

B. Loading the Salt into the Softener

Always use salt intended for use with dishwasher.

WATER SOFTENER

The hardness of the water varies from place to place. If hard water is used in the dishwasher, deposits will form on the dishes and utensils. The appliance is equipped with a special softener that uses salts specifically designed to eliminate lime and minerals from the water.

The salt container is located beneath the lower basket and should be filled as follows:

Attention!

Only use salt specifically designed for use in dishwashers! All other types of salt not specifically designed for use in a dishwasher, especially table salt, will damage the water softener. In case of damages caused by the use of unsuitable salt the manufacturer does not give any warranty nor is liable for any caused damages.

Only fill with salt just before starting one of the complete washing programmes. This will prevent any grains of salt or salty water, which may have been split, remaining on the bottom of the machine for any period of time, which may cause corrosion.

After the first wash cycle the control panel light expires.

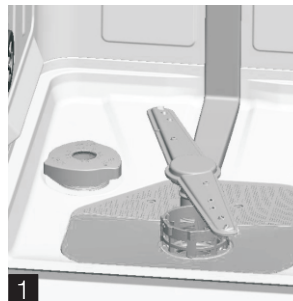

- A. Remove the lower basket and then unscrew and remove the cap from the salt container.
- B. If you are filling the container for the first time, fill 2/3 of its volume with water (around 500ml).
- C. Place the end of the funnel (supplied) into the hole and introduce about 3.3lb (1.5kg) of salt. It is normal for a small amount of water to come out of the salt container.
- D. Carefully screw the cap back on.
- E. Usually, the salt warning light will be off in 2-6 days after the salt container is filled with salt.

DISHWASHER SETUP

NOTE: 1. The salt container must be refilled when the salt warning light in the control panel comes on. Though the salt container is filled enough, the indicator light may not black out before the salt fully dissolve. If there is no salt warning light in the control panel (for some models), you can judge when to load the salt into the softener by the cycles that the dishwasher had run (see the following schema).
2. If there are spills of the salt, a Rinse program could be run to wipe them out.

C. Fill the Rinse Aid Dispenser

Function of Rinse Aid

Rinse aid is automatically added during the last rinse, ensuring thorough rinsing, spot and streak free drying.

Attention!

Only use branded rinse aid for dishwasher. Never fill the rinse aid dispenser with any other substances (e.g. dishwasher cleaning agent, liquid detergent). This would damage the appliance.

When to Refill the Rinse Aid Dispenser

If there is no rinse-aid warning light on the control panel, you can judge the amount of rinse-aid by the color of the optical level indicator "D" located next to the cap. When the rinse-aid container is full, the whole indicator will be dark. As the rinse aid diminishes, the size of the dark dot decreases. You should never let the rinse aid get below 1 / 4 full.

As the rinse aid diminishes, the size of the black dot on the rinse aid level indicator changes, as illustrated below.

- Full
- 3 / 4 full
- 1 / 2 full
- 1 / 4 full - Should refill to eliminate spotting
- Empty

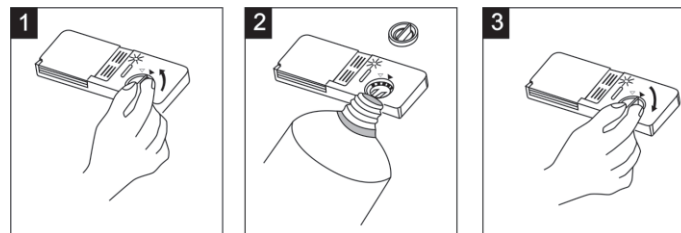
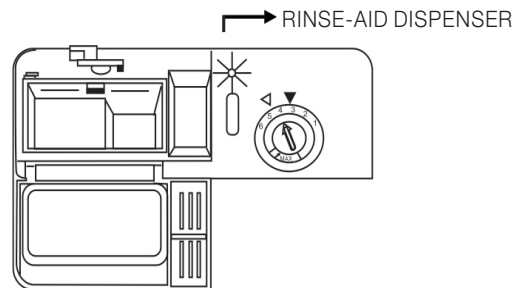

DISHWASHER SETUP

- 1 To open the dispenser, turn the cap to the "open" (left) arrow and lift it out.
- 2 Pour the rinse aid into the dispenser, be careful not to overfill. The volume of the rinse aid container is about 4.5oz. Be careful not to overfill the dispenser, because this could cause over sudsing. Wipe away any spills with a damp cloth.
- 3 Replace the cap by inserting it aligned with "open" arrow and turning it to the "closed" (right) arrow.

The rinse aid is released during the final rinse to prevent water from forming droplets on your dishes that can leave spots and streaks. It also improves drying by allowing water to sheet off the dishes. Your dishwashers are designed to use liquid rinse aids. The rinse aid dispenser is located inside the door next to the detergent dispenser. To fill the dispenser, open the cap and pour the rinse aid into the dispenser until the level indicator turns completely black. Don't forget to replace the cap before you close dishwasher door.

Attention!

Clean up any rinse aid spill during filling with an absorbent cloth to avoid excess foaming during the next wash.

Adjusting Rinse Aid Dispenser

The rinse aid dispenser has four or six settings. Always start with the dispenser set on "4". If spots and poor drying are problems, increase the amount of rinse aid dispensed by removing the dispenser lid and rotating the dial to "5". If the dishes still are not drying properly or are spotted, adjust the dial to the next higher number until your dishes are spot-free. The dose is factory set in the position 5.

C. Function of Detergent

Detergents with its chemical ingredients are necessary to remove dirt, crush dirt and transport it out of the dishwasher. Most of commercial quality detergents are suitable for this purpose.

Based on their chemical composition, dishwasher can be split in two basic types:

- conventional, alkaline detergents with caustic components
- low alkaline concentrated detergents with natural enzymes

The use of "Normal" washing program in conjunction with concentrated detergents reduces pollution and is good for your dishes; these washing programs are specially matched to the dirt-dissolving properties of the enzymes of the concentrated detergent. For this reason "Normal" washing program in which concentrated detergents are used can achieve the same results that can otherwise only be achieved using "intensive" program.

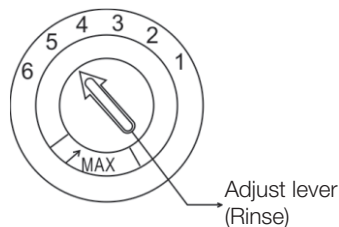

DISHWASHER SETUP

D. Function of detergent

Cannot dissolve and develop their full cleaning power during short programs. Therefore please use long programs when using detergent tablets, to ensure the complete removal of detergent residuals.

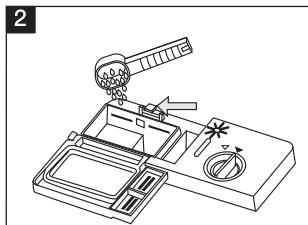
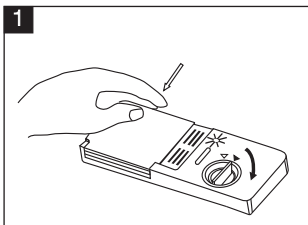

Detergent Dispenser

The dispenser must be refilled before the start of each washing cycle following the instructions provided in the Wash Cycle Table. Your dishwashers use less detergent and rinse aid than conventional dishwashers. Generally, only one tablespoon of detergent is needed for a normal wash load. Also, more heavily soiled items need more detergent. Always add the detergent just before starting dishwasher, otherwise it could get damp and will not dissolve properly. Amount of Detergent to Use

NOTE:

- 1 If the lid is closed: press release button. The lid springs open.
- 2 Always add the detergent just before starting each wash cycle. Only use branded detergent for dishwasher.

⚠ WARNING!

Dishwasher detergent is corrosive! Take care to keep it out of reach of children.

Based on their chemical composition, dishwasher can be split in two basic types:

- conventional, alkaline detergents with caustic components
- low alkaline concentrated detergents with natural enzymes

Use only detergent specifically made for use in dishwashers. Keep your detergent fresh and dry. Don't put powder detergent into the dispenser until you're ready to wash dishes.

Fill in the detergent

Fill the detergent dispenser with detergent. The marking indicates the dosing levels, as illustrated on the right:

- 1 The place of main wash cycle detergent placed, "MIN" means approximately 0.044lb of detergent.
- 2 The place of pre-wash cycle detergent placed, approximately 0.011lb of detergent.

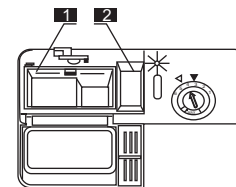

Please observe the manufacturer's dosing and storage recommendations as stated on the detergent packaging.

Close the lid and press until it locks in place.

If the dishes are heavily soiled, place an additional detergent dose in the pre-wash detergent chamber. This detergent will take effect during the pre-wash phase.

DISHWASHER SETUP

NOTE:

You find information about the amount of detergent for the single program on the last page.

Please be aware that according to the soiling level and the specific hardness of water, differences are possible.

Please observe the manufacturer's recommendations on the detergent packaging.

Detergents

There are 3 sorts of detergents

1. With phosphate and with chlorine
2. With phosphate and without chlorine
3. Without phosphate and without chloride

Normally new pulverized detergent is without phosphate. The water softener function of phosphate is not given. In this case we recommend to fill salt in the salt container even when the hardness of water is only 6 dH. If detergents without phosphate were used in case of hard water often white spots appear at dishes and glasses. In this case please add more detergent to reach better results.

Detergents without chlorine do only bleach a little. Strong and coloured spots will not removed completely. In this case please choose a programme with higher temperature.

DISHWARE MATERIALS

Note: Before using your dishwasher for the first time, check the information in this section.

Some items are not dishwasher safe and should be hand washed; others require special loading.

Recommended

Aluminum: Colored anodized aluminum may fade over time. Minerals in your water may cause the aluminum to darken or spot. This can usually be removed with a soap-filled steel wool pad.

China, Crystal, Stoneware: Some hand-painted utensils may discolor, fade or spot. Hand wash these utensils. Position fragile glassware so that it will not fall over or come in contact with other utensils during the wash cycle.

Glass: Milk glasses may discolor or become yellow.

Non-stick Coatings: Apply a light coating of vegetable oil to non-stick surfaces after drying.

Plastics: Make sure the plasticware is dishwasher safe.

Stainless Steel, Sterling Silver and Silver Plates: Load these so they do not come in contact with other metals.

Not Recommended

Acrylic: crazing, small cracks throughout the acrylic, may occur.

Adhesive-Joined Pieces: Adhesives that join materials such as plastic, wood, bone, steel, copper, tin, etc. may loosen.

Bone-Handled Utensils: Handles may separate.

Iron: Iron will rust. Hand wash and dry immediately.

Non-Dishware items: Your dishwasher is intended for use in cleaning ONLY standard house-hold dishware and kitchenware.

Pewter, Brass, Bronze: These items will tarnish. Hand wash and dry immediately.

Tin: Tin will stain. Hand wash and dry immediately.

Wood: Wooden bowls, wooden utensils and utensils with wooden handles can crack, warp and lose their finish.

LOADING THE DISHWASHER

For best performance of the dishwasher, follow these loading guidelines. Features and appearance of baskets and silverware baskets may vary from your model.

Attention before or after Loading the Dishwasher Baskets

Scrape off any large amounts of leftover food. It is not necessary to rinse the dishes under running water.

Place objects in the dishwasher in the following way:

1. Items such as cups, glasses, pots/pans, etc. are stood upside down.
2. Curve items, or those with recesses, should be at a slant so that water can run off.
3. They are stacked securely and can not tip over.
4. They do not prevent the spray arms from rotating while washing takes place.

Very small items should not be washed in the dishwasher as they could easily fall out of the baskets.

Removing the Dishes

To prevent water dripping from the upper basket into the lower basket, we recommend that you empty the lower basket first and then the upper basket.

Warning

The sharp points and edges of knives and other sharp utensils can cause serious injuries. Load knives and other sharp utensils with edges down. Do not allow children to handle or play near knives and sharp utensils.

Notice

To avoid dishwasher damage, do not load the dishwasher with paper products, plastic bags, packing materials or anything other than normal, dishwasher safe dishware and kitchenware.

Loading the Upper Basket

The upper basket is designed to hold more delicate and lighter dishware such as glasses, coffee and tea cup and saucers, as well as plates, small bowls and shallow pans (as long as they are not too dirty). Position the dishes and cookware so that they do not get moved by the spray of water.

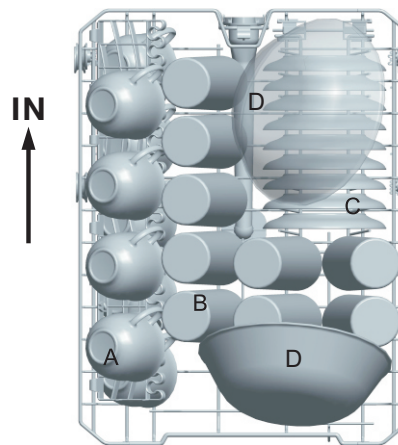

Upper basket	
Type	Item
A	Coffee Cup
B	Glass
C	Saucer
D	Serving Bowl

Upper Basket

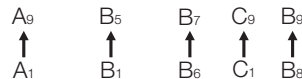

LOADING THE DISHWASHER

Adjusting the Upper Basket

If required, the height of the upper basket can be adjusted in order to create more space for large utensils either in the upper basket or lower basket. The upper basket can be adjusted for height by putting wheels of different height into the rails. Long items, serving cutlery, salad servers or knives should be placed on the shelf so that they do not obstruct the rotation of the spray arms. The shelf can be folded back or removed when not be required for use.

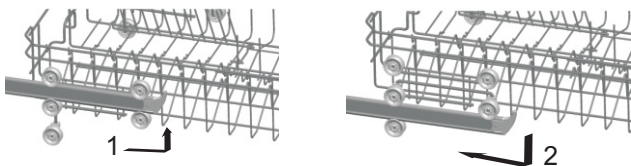

Loading the Lower Basket

We recommend that you place large items which are most difficult to clean in to the lower basket: pots, pans, lids, serving dishes and bowls, as shown in the figure below.

It is preferable to place serving dishes and lids on the side of the baskets in order to avoid blocking the rotation of the top spray arm. Pots, serving bowls, etc. must always be placed top down. Deep pots should be slanted to allow water to flow out. The bottom basket features fold down tine rows so that larger or more pots and pans can be loaded.

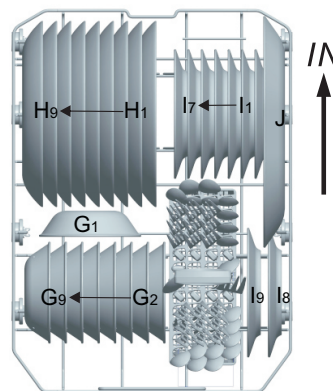

Lower basket	
Type	Item
G	Soup plate
H	Dinner plate
I	Dessert plate
J	Oval plate

Lower Basket

LOADING THE DISHWASHER

Upper and Lower basket Folding racks

Folding racks consisting of two parts that are located on the upper and lower basket of your machine are designed in order to let you place big items easier such as pots, pans, etc. If desired, each part can be folded separately, or all of them can be folded and a larger area can be obtained. You can use folding racks by raising them upwards, or by folding.

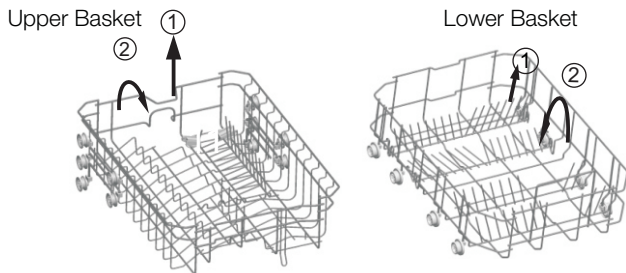

For optional

Cutlery Basket and Fork shelf

Cutlery should be placed in the cutlery basket with handles at the bottom: If the basket has side baskets, the spoon should be loaded individually into the appropriate slots, especially long utensils should be placed in the horizontal position at the front of the upper basket.

For washing in the dishwasher the following cutlery/dishes are not suitable: Cutlery with wooden, horn china or mother-of-pearl handles; Plastic items that are not heat resistant; Older cutlery with glued parts that is not temperature resistant; Bonded cutlery items or dishes; Pewter or copper items; Lead crystal glass; Steel items subject to rusting; Wooden platters; Items made from synthetic fibre.

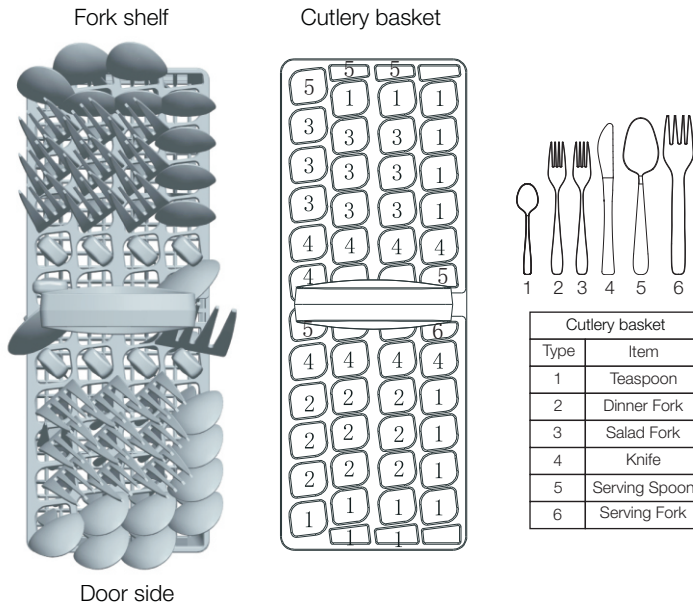

Door side

LOADING THE DISHWASHER

WARNING!

Do not let any item extend through bottom. Are of limited suitability. Some types of glasses can become dull after a large number of washes. Silver and aluminium parts have a tendency to discolour during washing. Glazed patterns may fade if machine washed frequently.

NOTE: Do not put in items that are dirty of cigarette ash, candle wax, lacquer or paint. If you buy new dishes please make sure that they are suitable for dishwashers.

NOTE: Please do not overload your dishwasher. There is only space for 9 standard place settings.

Do not use a dish that is not suitable for dishwashers. This is important for good results and for reasonable energy consumption.

Loading Cutlery and Dishes

Before loading the dishes, you should:

Remove large left-over foods.

Soften remnants of burnt food in pans by souring or scrubbing.

When Loading the Dishes and Cutlery, Please Note:

Dishes and cutlery must not impede the rotation of the spray arms. Load hollow items such as cups, glasses, pans etc. with the opening downwards so that water cannot collect in the container or a deep base.

Dishes and items of cutlery must not lie inside one another, or cover each other

- To avoid damage to glasses, they must not touch
- Load large items which are most difficult to clean into the lower basket

■ The upper basket is designed to hold more delicate and lighter dishware such as glasses, coffee and tea cups.

Attention!

Long bladed knives stored in an upright position are a potential hazard!

Long and/or sharp items of cutlery such as carving knives must be positioned horizontally in the upper basket.

Damage to Glassware and other Dishes

Possible causes:

■ Type of glass or manufacturing process. Chemical composition of detergent.

■ Water temperature and duration of dishwasher program.

Suggested remedy:

■ Use glassware or porcelain dishes that have been marked dishwasher-safe by the manufacturer.

■ Use a mild detergent that is described as kind of dishes. If necessary, seek further information from detergent manufacturers.

■ Select a program with a low temperature.

■ To prevent damage, take glass and cutlery out of the dishwasher as soon as possible after the programme has ended.

At the End of the Wash

When the working cycle has finished, the buzzer of dishwasher will ring 6 times, then stop.

Turn off the appliance using the "Power" button, and open the door of the dishwasher. Wait a few minutes before unloading the dishwasher to avoid handling the dishes and utensils while they are still hot and more susceptible to breakage. They will also dry better.

DISHWASHER CYCLES AND OPTIONS

Wash Cycles

Heavy: Best for cleaning items with baked-on food or grease. These dishes would normally require soaking.

Normal: This cycle is recommended to completely wash and dry a full load of normally soiled dishes. The energy usage label is based on this cycle and option combination.

Delicate: Provides a light wash and gentle dry for delicate items such as china and crystal.

Light: To save water and energy, high efficiency dishwashers use advanced filtration which may result in longer cycle times (in some cases, over 2 hours). When you need fast results, the Express Wash cycle will clean your dishes using slightly more water and energy. Then, towel dry dishes for immediate use. Select Sanitize if you want to add a drying option.

Express: Cleans lightly soiled dishes and reduces overall wash time. Use this cycle to clean glasses and dessert dishware that may need to be reused at the event.

Rinse: Allows you to rinse food soil off of a partial load and hold the dishes in the dishwasher until you are ready to run a full load.

Wash Cycles Options

Delay Start: Allows you to delay the start time of your dishwasher in one hour increments up to 24 hours.

WASH CYCLE INFORMATION

The cycle times in this Use and Care Manual are based on normal soil loads and 120° F incoming water and will vary based on your actual conditions.

Table1-Wash Cycle Information

	Heavy	Normal	Delicate	Light	Express	Rinse
cycle time	175min	144min	96min	70min	50min	12min
water consumption	22.2L 5.9gal	12.3L 3.2gal	11.9L 3.1gal	9.1L 2.4gal	9.1L 2.4gal	3.9L 1.0gal
water temperature	50-65°C 122-149°F	50-53°C 122-127°F	50°C 122°F	50-55°C 122-131°F	40°C 104°F	Water inlet temperature
rinse temperature	60°C 149°F	60°C 140°F	60°C 140°F	60°C 140°F	60°C 140°F	Water inlet temperature

OPERATING THE DISHWASHER



NOTE: Buttons are sensitive and should be touched gently. Avoid any grease or food particles resting on the buttons as they could activate the dishwasher. Wiping and cleaning can also activate the dishwasher. For best results, use bare, clean hands when touching the buttons.

1. ON/OFF Button: To turn on/off the power supply.
2. Program select button: Press the button to select the washing program.
3. Program indicator light: when you select a washing program, the corresponding light will display.
4. Drying light: To come on when the dishwasher is drying.
5. Washing/Inlet water abnormal status indicator: When the machine is washing, the "Wash" indicator is on. When the machine Inlet water abnormal in the water inlet stage, the "Water Supply" indicator. Flashing lights up.
6. Salt and rinse aid indicator light: To come on when the softener or dispenser needs to be filled.
7. Start/pause button: The appliance will start or pause the expected washing cycle.
8. Delay button: The START DELAY will allow you to delay the start time of any cycle automatically up to 24hours.
9. Digital display: To display the running time remain, malfunction codes and delay time.

WARNING

To avoid risk of injury, always use caution when opening the door during or following a wash cycle as hot water or steam may escape. Do not fully open the door until water noises have stopped and steam has subsided.

Turning on the Appliance

Starting a wash cycle...

Draw out the lower and upper basket, load the dishes and 1. push them back. It is recommended to load the lower basket first, then the upper one (see the section entitled "Loading the Dishwasher"). Pour in the detergent (see the section entitled "Salt, Detergent and Rinse Aid"). You must have: 120-volt, 60Hz, AC-only, 10- or 12-amp, fused electrical supply.

Make sure that the water supply is turned on to full pressure. Open the door, press the "Power" button, Press the "Program" button to select a desired "Wash cycle". (See the section entitled "Wash Cycle Table"). Press the Start/Pause button and close the door within 4 seconds and the dishwasher will be activated. If the door is not closed within 4 seconds after pressing the Start/Pause button, the power is off. In this state, the door is closed and the dishwasher will not start. Press the Start/Pause button again, the Digital Display indicator lights up, and the door is closed within 4 seconds. The dishwasher will be activated.

OPERATING THE DISHWASHER

NOTE: A click should be heard when the door is closed perfectly. When the washing is over, you can shut off the switch by pressing "Power" button.

Change the Program

The ongoing cycle can only be modified if the dispenser cover is not open (the door can be opened for viewing). Otherwise, the detergent may have already been released, and the appliance may have already drained the wash water. If this is the case, the detergent dispenser must be refilled (see the section entitled " Fill in the Detergent "). Press "Power" button to cancel the programme, and turn on it again, then you can change the programme to the desired cycle setting (see the section entitled "Starting a wash cycle. . . ").

NOTE: If you open the door when washing, the machine pauses and warning alarm rings, the display appears E1. You need to press the Start/Pause button and close the door within 4 seconds and the dishwasher will continue working. If the door is not closed within 4 seconds after pressing the Start/Pause button, the Digital Display is off. In this state, the door is closed and the dishwasher will not start. Press the Start/Pause button again, the Digital Display indicator lights up, and the door is closed within 4 seconds, The dishwasher will be continue working.

The 6 program lights show the state of the dishwasher:

- One of the program lights on--> cycle running
- One of the program lights blinking --> pause

NOTE: If all the lights begin to glimmer, that indicates the machine is out of order, please turn off the main power and water supply before calling a service.

Forget to Add Dish

A forgotten dish can be added any time before the detergent cup opens.

- Open the door a little to stop the washing.
- After the spray arms stop working, you can open the door completely.
- Add forgotten dishes.
- You need press the Start/Pause button and close the door within 4 seconds and the dishwasher will work after ten seconds.

WARNING!

It is dangerous to open the door when washing, because the hot water may scald you.

Switch Off the Dishwasher

The digital display appears "---" and the buzzer rings 6 times, only in this case the programme has ended.

- Switch off the dishwasher by pressing the "Power" button.
- Open the door carefully. Hot steam may escape when the door is opened!

■ Hot dishes are sensitive to knocks. The dishes should therefore be allowed to cool down around 15 minutes before removing from the appliance.

■ Open the dishwasher's door, leave it ajar and wait a few minutes before removing the dishes. In this way they will be cooler and the drying will be improved.

Unloading the dishwasher

It is normal that the dishwasher is wet inside.

Empty the lower basket first and then the upper one. This will avoid water dripping from the upper basket onto the dishes in the lower one.

MAINTENANCE AND CLEANING

Filtering System

The filter is used to avoid the big remnants and other food particles getting inside the pump. The residue can obstruct the filter.

The filter system consists of a coarse filter, a flat (Main filter) and a micro filter (fine filter).

1 Flat filter: Food and debris will be trapped by a special jet on the lower spray arm.

2 Coarse filter: Big debris, such as bone and glass that could clog the drain will be trapped in the coarse filter.

To remove an item caught in this filter, gently squeeze the taps on the top of this filter and lift it out.

3 Micro filter: This filter holds soil and food residue in the sump area and prevents it from being redeposit on the dishes during a cycle.

- Inspect the filters for obstructions every time the dishwasher has been used.
- By unscrewing the coarse filter, you can remove the filter system. Remove any food remnants and clean the filters under running water.

Step 1: Contrarotate the coarse filter, and then lift it up;
Step 2: lift the Flat filter up

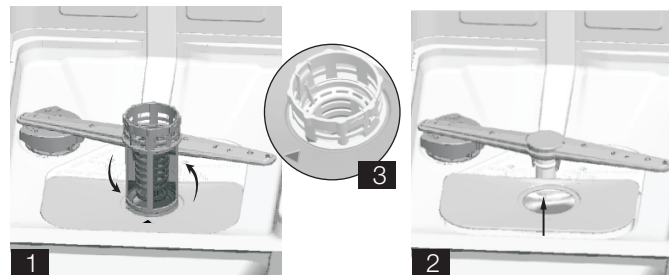
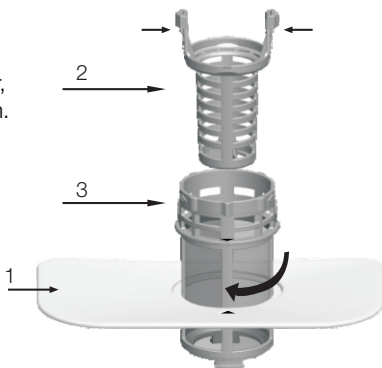

NOTE: If operate from step 1 to step 2, the filter system will be removed; while operate from step 2 to step 1, the filter system will be installed.

Filter assembly

For best performance and results, the filter assembly must be cleaned. The filter efficiently removes food particles from the wash water, allowing it to be recirculated during the cycle. For this reason, it is a good idea to remove the larger food particles trapped in the filter after each wash cycle by rinsing the semicircular filter and cup under running water. To remove the filter assembly, pull on the cup handle in the upward direction. The entire filter assembly should be cleaned once a week. To clean the coarse filter and the micro filter, use a cleaning brush. Then, reassemble the filter parts as shown in the figures above and reinsert the entire assembly in the dishwasher, positioning in its seat and pressing downward. The dishwasher must never be used without the filters. Improper replacement of the filter may reduce the performance level of the appliance and damage dishes and utensils.

MAINTENANCE AND CLEANING

WARNING!

Never run the dishwasher without the filters in place. When cleaning the filters, don't knock on them.

Cleaning the Spray Arms

It is necessary to clean the spray arms regularly or hard water chemicals will clog the spray arm jets and bearings.

To remove the spray arms, screw off the nut clockwise to take out the washer on top of the spray arm and remove the arm. Wash the arms in soapy and warm water and use a soft brush to clean the jets. Replace them after rinsing thoroughly.



Caring for the Dishwasher

To clean the control panel, use a lightly dampened cloth then dry thoroughly.

To clean the exterior, use a good appliance cleaner.

Never use sharp objects, scouring pads or harsh cleaners on any part of the dishwasher.

Protect Against Freezing

If your dishwasher is left in an unheated place during the winter, ask a service technical to:

1. Cut off electrical power to the dishwasher.
2. Turn off the water supply and disconnect the water inlet pipe from the water valve.
3. Drain water from the inlet pipe and water valve. (Use a pan to catch the water)
4. Reconnect the water inlet pipe to the water valve.
5. Remove the filter in the tub and the bottom and use a sponge to use up water in sump

Cleaning the Door

To clean the edge around the door, you should use only a soft warm, damp rag. To prevent penetration of water into the door lock and electrical components, do not use a spray cleaner of any kind.

Also, never use abrasive cleaners or scouring pads on the outer surfaces because they will scratch the finish. Some papers towels can also scratch or leave marks on the surface.

WARNING!

Never use a spray cleaner to clean the door panel for it could damage the door lock and electrical components. It is not allowed to use the abrasive agent or some paper towel because of the risk of scratching or leaving spots on the stainless steel surface.

TROUBLESHOOTING TIPS

Error codes

When some malfunctions happen, the appliance will display error codes to warn you.

Codes	Meanings	Possible Causes
E1	Door open	The door is opened when the dishwasher is operating
E2	Water inlet	Water inlet malfunction
E3	Water drainage	Water drainage malfunction
E4	Temperature sensor	Temperature sensor malfunction
E5	Overflow/leakage	Overflow occurs/Water leakage occurs
E6	Water leakage	Water leakage occurs
E7	Heating element	Abnormal heating

WARNING!

If overflow occurs, turn off the main water supply before calling a service. If there is water in the base pan because of an overfill or small leak, the water should be removed before restarting the dishwasher.

Before Calling for Service

Reviewing the charts on the following pages may make you be free of calling for service.

Problem	Possible Causes	What To Do
 Dishwasher doesn't run	Fuse blown, or the circuit breaker acted	Replace fuse or reset circuit breaker. Remove any other appliances sharing the same circuit with the dishwasher.
	Power supply is not turned on	Make sure the dishwasher is turned on and the door is closed securely. Make sure the power cord is properly plugged into the wall socket.
	Water pressure is low	Check that the water supply is connected properly and the water is turned on.
Drain pump doesn't stop	Overflow	The system is designed to detect an overflow. When it does, it shuts off the circulation pump and turns on the drain pump.

TROUBLESHOOTING TIPS

Problem	Possible Causes	What To Do
Noise	Some audible sounds are normal	Sound from detergent cup opening.
	Utensils are not secure in the baskets or something small has dropped into the basket	To ensure everything is secured in the dishwasher.
	Motor hums	Dishwasher has not been used regularly. If you do not use it often, remember to set it to fill and pump out every week, which will help keep the seal moist.
Suds in the tub	Improper detergent	Use only the special dishwasher detergent to avoid suds. If this occurs, open the dishwasher and let suds evaporate. Add 1 gallon of cold water to the tub. Close and latch the dishwasher, then start the "pre-rinse" wash cycle to drain out the water... Repeat if necessary.
	Spilled rinse agent	Always wipe up rinse agent spills immediately.
Stained tub interior	Detergent with colorant was used	Make sure that the detergent is the one without colorant.
Dishes and flatware not clean	Improper program Improper basket loading	Select a stronger program. Make sure that the action of the detergent dispenser and spray arms are not blocked by large dishware.

TROUBLESHOOTING TIPS

TROUBLESHOOTING TIPS

Problem	Possible Causes	What To Do
Spots and filming on glasses and flatware	<ol style="list-style-type: none"> 1 Extremely hard water 2 Low inlet temperature 3 Overloading the dishwasher 4 Improper loading 5 Old or damp powder detergent 6 Empty rinse agent dispenser 7 Incorrect dosage of detergent 	<p>To remove spots from glassware:</p> <ol style="list-style-type: none"> 1 Take out all metal utensils out of the dishwasher. 2 Do not add detergent. 3 Choose the longest cycle. 4 Start the dishwasher and allow it to run for about 18 to 22 minutes, then it will be in the main wash. 5 Open the door to pour 2 cups of white vinegar into the bottom of the dishwasher. 6 Close the door and let the dishwasher complete the cycle. If the vinegar does not work: Repeat as above, except use 1/4 cup (60 ml) of citric acid crystals instead of vinegar.
Cloudiness on glassware	Combination of soft water and too much detergent	Use less detergent if you have soft water and select a shortest cycle to wash the glassware and to get them clean.
Yellow or brown film on inside surfaces	Tea or coffee stains	<p>Using a solution of 1/2 cup of bleach and 3 cups of warm water to remove the stains by hand.</p> <p>▲WARNING You have to wait for 20 minutes after a cycle to let the heating elements cool down before cleaning interior; otherwise, burns will happen.</p>
	Iron deposits in water can cause an overall film	You have to call a water softener company for a special filter.
White film on inside surface	Hard water minerals	To clean the interior, use a damp sponge with dishwasher detergent and wear rubber gloves. Never use any other cleaner than dishwasher detergent for the risk of foaming or suds.

TROUBLESHOOTING TIPS

Problem	Possible Causes	What To Do
The Detergent dispenser lid cannot be closed properly	Clogged detergent residue is blocking the catch	Clean the detergent from the catch.
Detergent left in dispenser cups	Dishes block detergent Cups	Re-loading the dishes properly.
Steam	Normal phenomenon	There is some steam coming through the vent by the door latch during drying and water draining.
Black or gray marks on dishes	Aluminum utensils have rubbed against dishes	Use a mild abrasive cleaner to eliminate those marks.
Water standing on the bottom of the tub	This is normal	A small amount of clean water around the outlet on the tub bottom keeps the water seal lubricated.
Dishwasher leaks	Overfill dispenser or rinse aid spills	Be careful not to overfill the rinse aid dispenser. Spilled rinse aid could cause oversudsing and lead to overflowing. Wipe away any spills with a damp cloth.
	Dishwasher isn't level	Make sure the dishwasher is level.

Consignes de sécurité importantes

Consignes de sécurité importantes:

Veuillez lire et conserver ces informations

AVERTISSEMENT

■ Une mauvaise utilisation du lave-vaisselle peut entraîner des blessures graves ou la mort. Ne pas utiliser le lave-vaisselle d'une manière qui n'est pas traitée dans le présent guide ou à des fins autres que celles qui sont expliquées dans les pages qui suivent.

■ Des dommages au produit et/ou blessures graves peuvent survenir par suite de l'emploi de techniciens en entretien et en réparation non qualifiés ou de pièces de rechanges qui ne sont pas d'origine. Toutes les réparations doivent être effectuées par un technicien en entretien et en réparation qualifié qui utilise des pièces de rechange du fabricant de l'équipement d'origine.

■ Un choc électrique ou un incendie peut résulter de l'installation inexacte de l'alimentation électrique du lave-vaisselle traité dans le présent guide ou d'une mauvaise mise à la terre du lave-vaisselle. Ne pas utiliser le lave-vaisselle traité dans le présent guide à moins d'être certain que l'alimentation électrique a été correctement installée ou que le lave-vaisselle a été correctement mis à la terre.

■ Ne jamais nettoyer votre lave-vaisselle avec des produits chimiques puissants. Certains produits contenant des chlorures peuvent endommager votre lave-vaisselle et poser des risques pour la santé !

AVIS

■ Ne jamais nettoyer votre lave-vaisselle avec des produits de nettoyage à la vapeur. Le fabricant n'assume aucune responsabilité pour d'éventuels dommages ou conséquences.

■ Il est vivement recommandé à l'utilisateur final de se familiariser avec les procédures de fermeture de l'alimentation d'eau entrante et de coupure de l'alimentation électrique entrante. Reportez-vous aux instructions d'installation ou communiquez avec votre installateur pour de plus amples renseignements.

■ Pour éviter d'endommager les lavevaisselle, ne pas utiliser de produits chimiques, de produits nettoyants abrasifs, de tampons à récurer (métal ou plastique), ou abrasifs serviettes tis-sus / papier pour nettoyer le panneau de porte extérieur de votre lavevaisselle. Panneau de porte extérieur de votre lave-vaisselle peut être endommagé en le faisant.

■ NSF / ANSI 184 lave-vaisselle résidentiels certifiés ne sont pas destinés aux établissements alimentaires autorisés.

 **AVERTISSEMENT** : Pour réduire le risque d'incendie, de choc électrique ou de blessure grave, respectez les consignes suivantes :

1. Ce lave-vaisselle est fourni avec les instructions d'installation et le présent guide d'utilisation et d'entretien. Lire et comprendre toutes les instructions avant de faire fonctionner le lave-vaisselle.

Consignes de sécurité importantes

2. AVERTISSEMENT. Lorsque vous utilisez votre lave-vaisselle, prenez des mesures de précautions élémentaires, y compris les suivantes :

- a) Lisez toutes les instructions avant d'utiliser le lave-vaisselle.
- b) N'utilisez le lave-vaisselle que pour laver la vaisselle.
- c) Utilisez les détergents recommandés pour lave-vaisselle et gardez-les hors de la portée des enfants.
- d) Lorsque vous chargez le lave-vaisselle:
 - 1) Placez les objets coupants de façon qu'ils ne puissent endommager le sceau de la porte.
 - 2) Placez les couteaux avec le manche vers le haut de façon à ne pas vous couper.
- e) Ne pas laver d'articles en plastique à moins qu'ils ne soient marqués «Peut aller au lavevaisselle » ou l'équivalent. Si l'article ne porte aucune indication, vérifiez auprès du fabricant.
- f) Ne touchez pas l'élément chauffant pendant le fonctionnement de l'appareil ou immédiatement après.
- g) Ne faites pas fonctionner le lave-vaisselle si tous le panneaux du bâti ne sont pas en place.
- h) Ne jouez pas avec les commandes.
- i) Évitez de vous asseoir ou de monter sur la porte du lave-vaisselle.
- j) Pour éviter tout risque d'accident, ne laissez pas les enfants jouer dans ou sur le lavevaisselle.
- k) Dans certaines conditions, de l'hydrogène peut se former dans un réseau d'eau chaude inutilisé depuis deux semaines ou plus.
L'HYDROGÈNE EST UN GAZ EXPLOSIF. Si le système d'eau chaude n'a pas été utilisé depuis un certain temps, laissez couler l'eau chaude des robinets pendant quelques minutes avant de faire fonctionner le lave-vaisselle. Cette mesure permettra à l'hydrogène de s'évaporer. Ce gaz étant inflammable; attention de ne pas fumer ni utiliser de flamme nue pendant cette période.
- l) Enlevez la porte du lave-vaisselle lorsque vous le remplacez ou le mettez au rebut.

3. Afin d'éviter d'endommager le plancher et la formation éventuelle de moisissures, ne laissez aucune trace d'eau sur le sol adjacent au lave-vaisselle ou sous ce dernier.

4. Protégez votre lave-vaisselle des éléments. Protégez-le contre le gel afin d'éviter les dommages éventuels au robinet de remplissage. Les dommages causés par le gel ne sont pas couverts par la garantie.

5. AVERTISSEMENT. Pour réduire le risque de choc électrique, d'incendie ou de blessure, l'installateur doit s'assurer que l'enceinte est complète au moment de l'installation.

6. Cet appareil doit être mis à la terre. En cas de mauvais fonctionnement ou de bris de l'appareil, la mise à la terre réduira les risques de choc électrique en offrant un parcours de moindre résistance au courant électrique. Cet appareil est pourvu d'un cordon à conducteur de terre et d'une fiche de mise à la terre. Brancher la fiche dans une prise installée adéquatement et mise à terre conformément à tous les codes et règlements locaux.

AVERTISSEMENT. Une mauvaise connexion du conducteur de terre peut présenter des risques de choc électrique. Consulter un électricien ou un technicien qualifié si vous n'êtes pas certain que l'appareil est mis à terre adéquatement. Ne pas modifier la fiche de l'appareil. Si elle ne pénètre pas bien dans la prise, faire installer une prise adéquate par un électricien qualifié.

AVERTISSEMENTS DE LA PROPOSITION 65 DE L'ÉTAT DE LA CALIFORNIE :

AVERTISSEMENT : Cet appareil contient un ou plusieurs produits chimiques qui, selon l'État de la Californie, peuvent causer le cancer, des malformations ou d'autres problèmes congénitaux.

LIMITED WARRANTY

IN-HOME SERVICE FULL ONE YEAR WARRANTY

For 12 months from the date of original retail purchase, Galanz will repair or replace any part free of charge including labor that fails due to a defect in materials or workmanship. Galanz may replace or repair at their sole discretion any part, or sub system including the entire product. Product must be accessible, without encumbrance and installed properly to receive warranty repair service.

LIMITED WARRANTY

NOTE: This warranty commences on the date the item was purchased, or ownership assumed from a builder and the original purchase receipt must be presented to the authorized service representative before warranty repairs are rendered.

Exceptions:Commercial Use Warranty

90 days labor from date of original purchase

90 days parts from date of original purchase

No other warranty applies.

FOR WARRANTY SERVICE

All service must be performed by a Galanz authorized service .

For service, please call 1-800-562-0738. Before calling please have available the following information: (a) Model number and serial number of your appliance. (b) The name and address of the dealer you purchased the unit from and the date of purchase. (c) A clear description of the problem. (d) A proof of purchase (sales receipt).

This warranty covers home appliance services within the contiguous United States and where available in Alaska, Hawaii and Puerto Rico.

What is not covered by this warranty:

Replacement or repair of household fuses, circuit breakers, wiring or plumbing. A product whose original serial number has been removed or altered. Any service charges not specifically identified as normal such as normal service area or hours.

Replacement of light bulbs.

Damage to clothing.

Damage incurred in shipping.

Damage caused by improper installation or maintenance.

Damage from misuse, abuse accident, fire, flood, or acts of nature.

Damage from service other than an authorized Galanz dealer or service center.

Damage from incorrect electrical current, voltage or supply.

Damage resulting from any product modification, alteration or adjustment not authorized by Galanz.

Adjustment of consumer operated controls as identified in the owner's manual.

Hoses, knobs, lint trays and all attachments, accessories and disposable parts.

Labor, service transportation, and shipping charges for the removal and replacement of defective parts beyond the initial 12-month period.

Damage from other than normal household use.

Any transportation and shipping charges.

THIS LIMITED WARRANTY IS GIVEN IN LIEU OF ALL OTHER WARRANTIES, EXPRESS ED OR IMPLIED, INCLUDING BUT NOT LIMITED TO, THE WARRANTIES OF MERCHANTABILITY AND FITNESS FOR A PARTICULAR PURPOSE

The remedy provided in this warranty is exclusive and is granted in lieu of all other remedies.

This warranty does not cover incidental or consequential damages, so the above limitations may not apply to you.

Some states do not allow limitations on how long an implied warranty lasts, so the above limitations may not apply to you.

This warranty gives you specific legal rights, and you may have other rights, which vary from state to state.

WARRANTY REGISTRATION

Please mail this warranty card to the address below within 30 days of purchase.

Galanz Americas, 55 Challenger Road, Suite 503, Ridgefield Park, NJ 07660.

PLEASE PRINT CLEARLY.

Name _____

Address _____

City _____ State _____ ZIP _____

Phone _____ Email _____

Model Number _____ Serial Number _____

Purchase Location _____

You must attach a copy of your purchase receipt to validate your registration.

Galanz