

## **CUSTOMER SERVICE**

Our customer service team is standing by to assist you  
if you have any questions or concerns.

 [www.mookashops.com](http://www.mookashops.com)

 [support@mookashops.com](mailto:support@mookashops.com)

 1-855-666-9955

**READ AND SAVE THESE INSTRUCTIONS**

## **DIRECTORY**

IMPORTANT SAFEGUARDS .....	01
ATTENTION .....	05
PRODUCT TECHNICAL FEATURES .....	07
PRODUCT APPEARANCE DIAGRAM .....	08
PART INTRODUCTION .....	09
USE AND OPERATION .....	10
OPERATION INTRODUCTION .....	14
INSTRUCTIONS FOR USE .....	15
CLEANING AND CARE/FAQ .....	22
FILTER MAINTENANCE .....	23
PARAMETERS OF THE UNIT .....	24

In order to prevent harm or damage happened to users or others, be sure to comply with the requirement as below:

## WARNING/ATTENTION



### WARNING

It reminds that misusing or mishandling may cause death.



### ATTENTION

It reminds that misusing or mishandling may cause hurt.



**FORBID**



**FORCE**

Unplug or disconnect the appliance from the power supply before servicing.

WARNING: To Reduce The Risk Of Fire Or Electric Shock, Do Not Use This Fan With Any Solid-State Speed Control Device.

WARNING: To Reduce The Risk Of Fire, Electric Shock Or Injury To Persons, Do Not Use Replacement Parts That Have Not Been Recommended By The Manufacturer (e.g. Parts Made At Home Using A 3D Printer)

## 2 IMPORTANT SAFEGUARDS



### WARNING



Please supervise your children and avoid them from touching or using machine.



Do not connect or disconnect the power with wet hand.  
It may cause electrical shocking.

AVOID WET



Do not disassemble, repair or reconstruct.  
It may cause fire or damage.  
Please contact the seller for replacement.

NO DISASSEMBLE



Do not use over-limit sockets or wiring connectors. Please use the rated voltage.  
It may cause a fire.

FORBID

## IMPORTANT SAFEGUARDS 3



**Do plug the power into the socket completely.**

It may cause fire because of heating or electrical shocking.  
Do not use the damaged plug or loose socket.



**Avoid any water on the surface of the unit.**

It may cause short circuit or electrical shocking.

**AVOID WET**



**The appliance must be disconnected from the supply mains before cleaning or other maintenance.**

Otherwise the unit may start working in a sudden which may cause electrical shocking or hurt.

**DISCONNECT POWER**

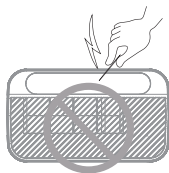

**Do not insert any metal objects into the unit.**

It may cause hurt or electric shocking.

## 4 IMPORTANT SAFEGUARDS



**FORBID**

**Do not repair it when the cord or plug is damaged.**

It may cause short circuit, electric shocking or fire. Please contact the retailer for replacement.



**If there is dust on the plug, it may weaken the insulation and even cause a fire.**

Take out the plug and clean it with dry cloth.

Please remove the plug from the socket if not using for a long period.



### ATTENTION



**Do not use in the room with a gas stove.**

It may cause hurt because the machine is not a ventilator.

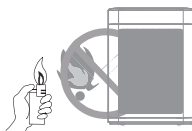

**Do not place the unit near fires.**

It may cause fire.

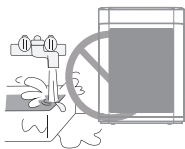

**Do not use in the watery or high temperature room such as the bathroom etc.**

Otherwise it may cause creepage, electric shocking or fire.

The multi-functional filter is composed of pre-filter, HEPA layer and activated carbon layer.

### DIAGRAM OF PURIFICATION

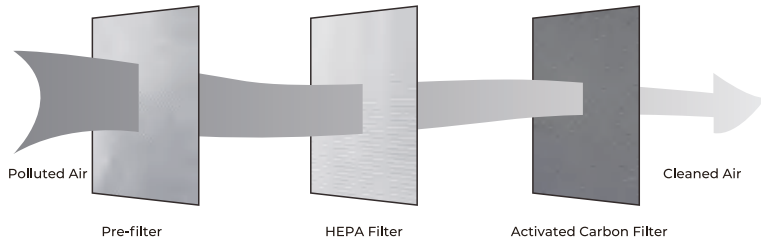

## 8 PRODUCT APPEARANCE DIAGRAM

### DECOMPOSITION DIAGRAM

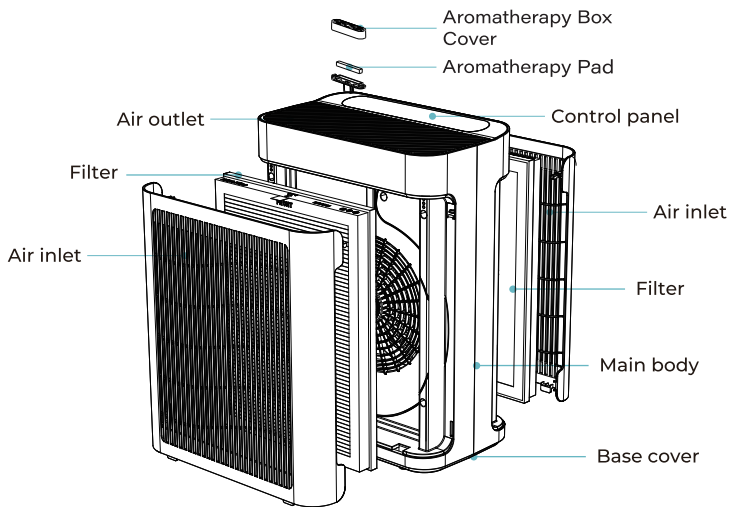

## DIAGRAM OF CONTROL PANEL

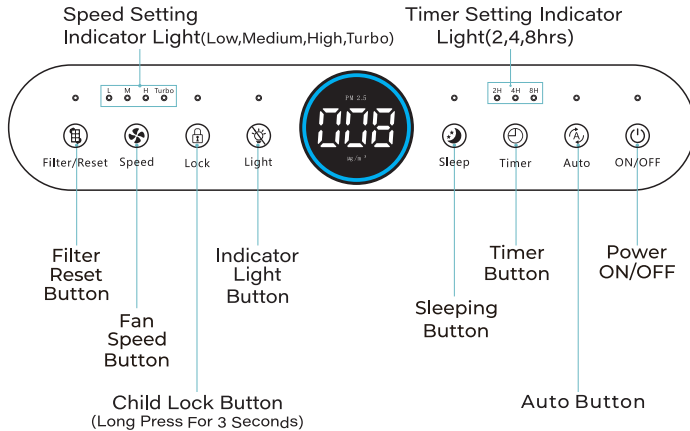

## 10 USE AND OPERATION

### PLACEMENT

- ◆ Make sure the appliance is placed at least 30cm away from any wall or piece of furniture. Do not position the appliance directly under furniture or objects that may obstruct the exhaust air flow.
- ◆ Do not use the appliance near any source of heat.

### REPLACE THE FILTER

- ◆ Replace the filter and reset.

The filter replacement indicator will light up when cumulative running time reaches 2160hrs. Please replace the filter with a new one. Then, press and hold the reset button for approximately 3 seconds to reset the filter's lifetime counter, and the filter replacement indicator will turn off.

### REMOVE THE FILTER

1. Switch the appliance off and unplug it.
2. Remove the inlet grille.
3. Grab the top rope of the filter and pull it out.
4. Take out the filter and close the inlet grille.

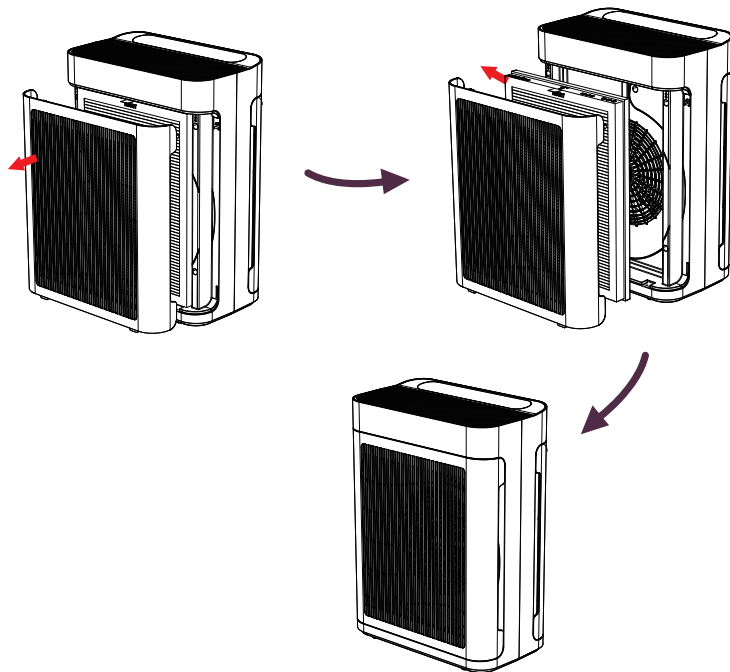

## 12 USE AND OPERATION

### INSTALL THE FILTER

1. Please remove the new filter protective film before installation.
2. Please fasten the inlet grille correctly until the filter is firmly installed.

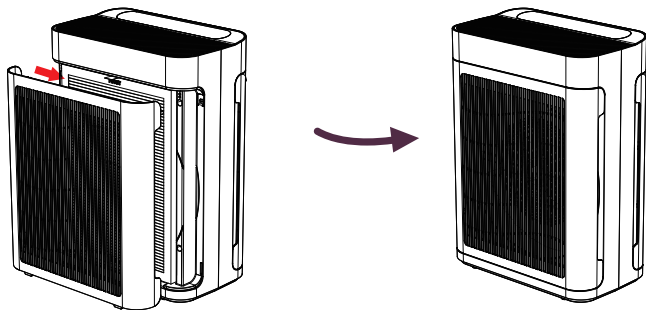

## EXTERNAL POWER SOURCE

Suitable Voltage: 24V 

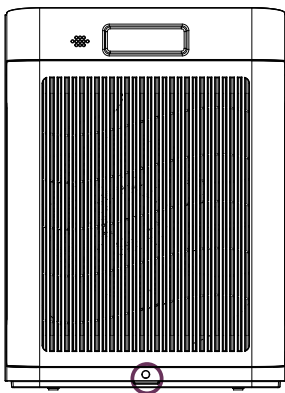

24V DC power adapter inlet



Power adapter

## 14 OPERATION INTRODUCTION

### ! BEFORE OPERATING THE AIR PURIFIER:

1. Carefully remove your air purifier from box and plastic bag.
2. Select a firm, level, and flat location for the air purifier.  
\*For proper air flow, locate the unit at least 1 foot from any wall or furniture.
3. Before using, remove the plastic bags covering the filters.
4. Plug the power cord into an 100-240V AC outlet.

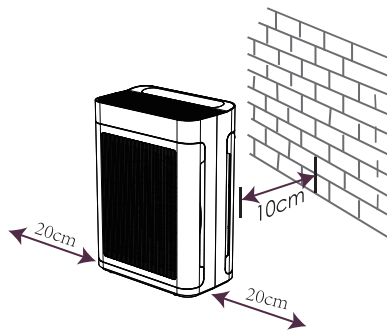
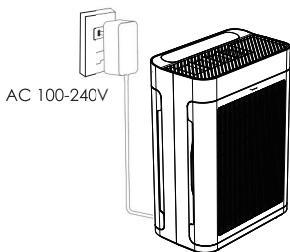

# INSTRUCTIONS FOR USE 15

## POWER SETTING

- ◆ All the indicator lights will be on for 3 second for self-checking after connecting power, then enter standby mode. The pictures below are for reference.
- ◆ To turn on or switch off the appliance, press the power button while in standby mode.

## FAN SPEED SETTING

Press the fan speed button to select the fan speed: low, medium, high, Turbo speed.

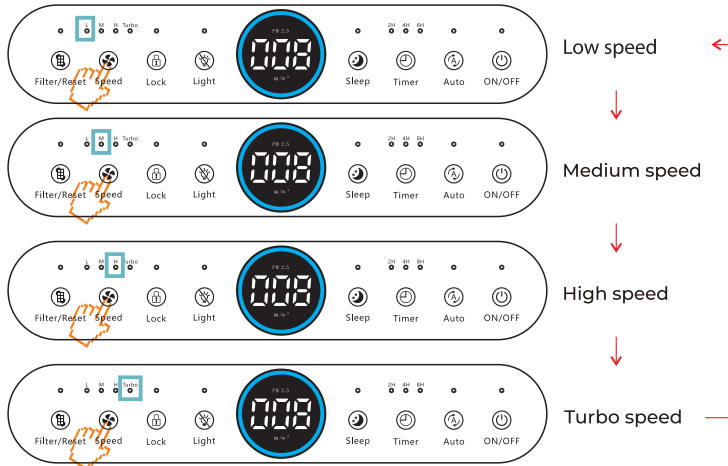

# 16 INSTRUCTIONS FOR USE

## TIMER SETTING

- ◆ Press the timer button to set the working time.

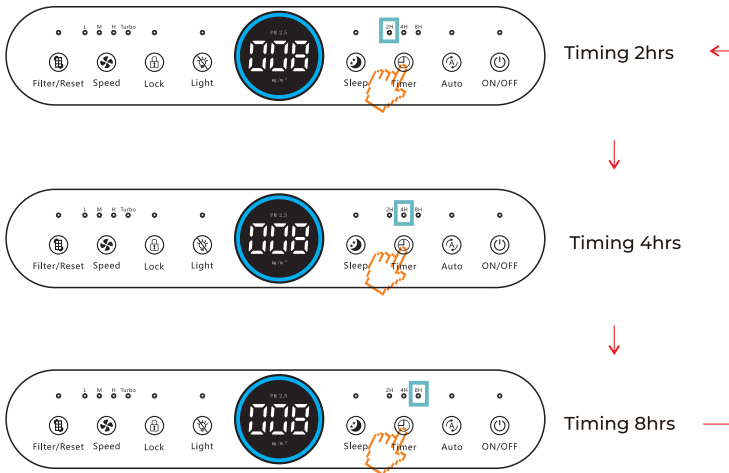

## INSTRUCTIONS FOR USE 17

- ◆ Use the control lock to temporarily lock the control panel and deactivate the function buttons. To turn on or deactivate the child lock, press and hold the child button on the top control panel for approx. 3 seconds. Child lock indicator light on the display will light up or be switched off accordingly

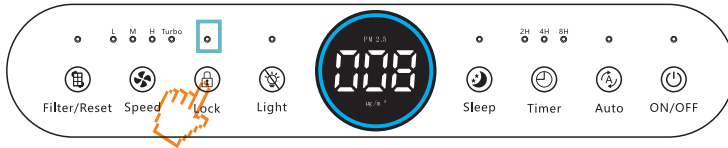

## 18 INSTRUCTIONS FOR USE

- ◆ The filter replacement indicator will light up when the cumulative running time reaches 2160 hours. Please replace the filter with a new one. Then, press and hold the reset button for approximately 3 seconds to reset the filter's lifetime counter, and the filter replacement indicator will turn off.



Filter replacement indicator light on

## SLEEPING MODE

- ◆ To turn on or deactivate sleep mode by pressing sleep button. Sleep mode sets the appliance to the lowest speed setting with fan speed indicator light switched off and Sleep mode indicator half lit.

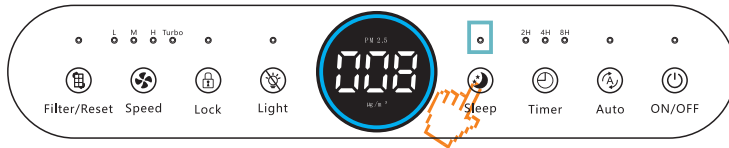

Turn on sleep mode

## 20 INSTRUCTIONS FOR USE

### USE AMBIENT LIGHT FUNCTION

- ◆ Press Indicator light button to turn on or switch off the Indicator light



Switch off /Turn on Indicator light

## AUTO MODE

- ◆ Touch this button to enter the automatic mode, the corresponding indicator light will be high lighted in white, and the machine will automatically regulate the gear wind speed according to the real-time air quality index.

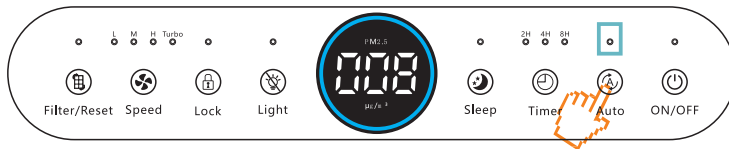

Turn on Auto mode

Note: Auto's specific working gears should be made to correspond to the change of PM2.5 values.

Three colors, corresponding to three gears.

Air Quality Indicator Bad	AQI
Blue	0~35
Green	36~75
Red	76~999

### MAINTENANCE AND CLEANING METHODS



Please remove plug from the socket before cleaning and maintenance .

- ◆ Cleaning the body for this device by damp cloth, then wipe it dry.
- ◆ If the machine is too dirty, neutral detergent can be used for cleaning, but please dilute the detergent before use.
- ◆ Do not clean the unit with the solvent listed on the right which may cause distortion or discolour.

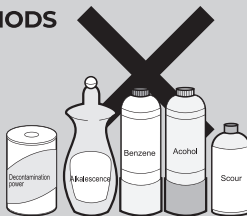

If the machine can't work properly, please kindly check as below before you send it out for repair

Problem	Checking methods	Possible solution
Do not work	<ul style="list-style-type: none"> <li>• Please check if the plug is disconnected from the socket.</li> </ul>	<ul style="list-style-type: none"> <li>➔ Power plug should be plugged properly</li> </ul>
Odor can not be removed	<ul style="list-style-type: none"> <li>• Is there a very strong odor in the using environment? (Notes: air should be purified continuously)</li> </ul>	<ul style="list-style-type: none"> <li>➔ It is recommended to ventilate first and then turn on the machine</li> </ul>
	<ul style="list-style-type: none"> <li>• Does the using life time for filters come to the end?</li> </ul>	<ul style="list-style-type: none"> <li>➔ Please replace the used filter with a new one.</li> </ul>
High noise	<ul style="list-style-type: none"> <li>• Is the PE bag for filter removed?</li> </ul>	<ul style="list-style-type: none"> <li>➔ Please take out filter and tear off PE bag.</li> </ul>
	<ul style="list-style-type: none"> <li>• Does the using life time for filter come to the end?</li> </ul>	<ul style="list-style-type: none"> <li>➔ Please replace the used filter with a new one.</li> </ul>

If the problem is still existed after above inspections, please disconnect the power and it for repair

## CLEANING THE FILTERS

1. Remove the air inlet grilles from the front and back of the machine and take out both filters. (Unplug the air purifier before cleaning.)
2. Remove the washable pre-filters.
3. Rinse the pre-filters under water.
4. After cleaning, make sure the pre-filter is completely dry before reinstalling it.

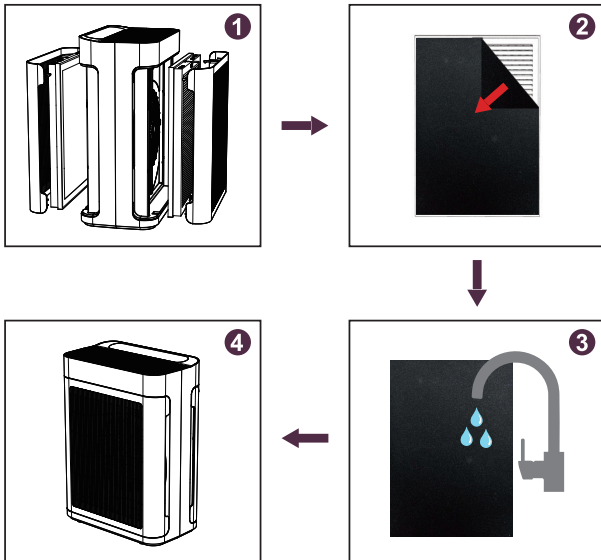

## 24 PARAMETERS OF THE UNIT

### PARAMETERS OF THE UNIT

Model No.:	TM06
Voltage Supply:	24V ==
Power consumption(w):	42.5W
Net Weight:	3.2Kg±0.5kg
Dimensions(wxdxh):	300×170×406 (mm)

### FILTER PARAMETERS

Item name	Dimensions(wxdxh)	Life time
High efficiency composit filter	314×233×27mm	2160H

