

① X1

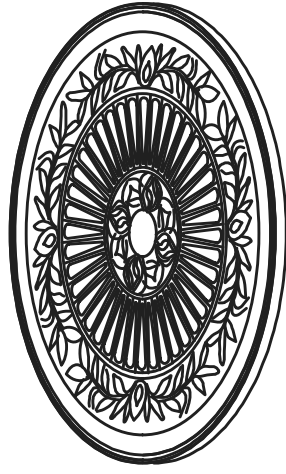

② X3

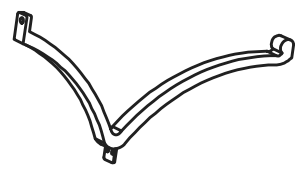

③ X1

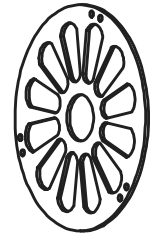

Ⓐ X6



M6*35
Bolt / Bolzen
Boulon / Perno
Bullone / Sruba
Bout

Ⓑ X3



M8*30
Bolt / Bolzen
Boulon / Perno
Bullone / Sruba
Bout

Ⓒ X6



6mm

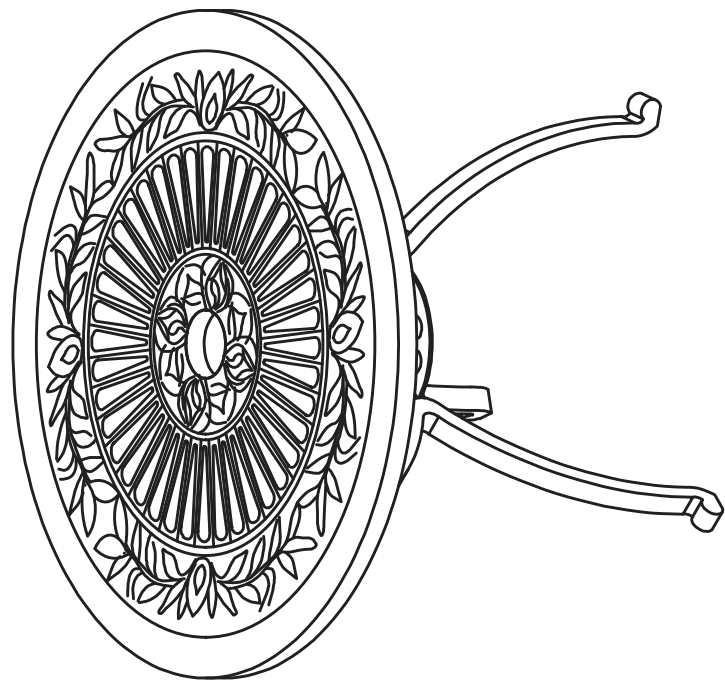

(D) X6



6mm

(E) X6



6mm

(F) X6



6mm

(G) X3



8mm

(H) X3



8mm

(I) X3



8mm

(J) X3



8mm



1

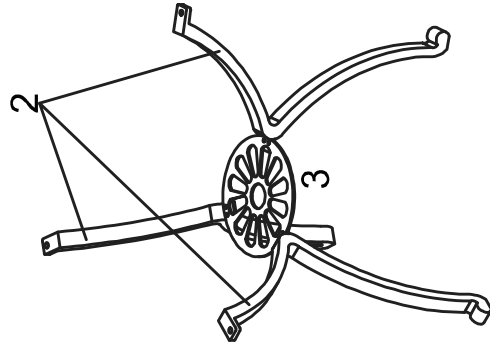

(A) X6 (C) X6 (D) X6
(E) X6 (F) X6

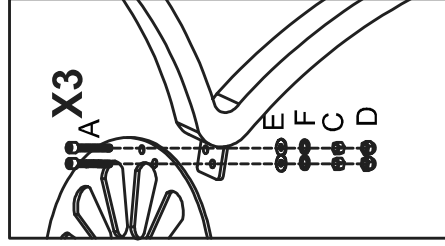

2

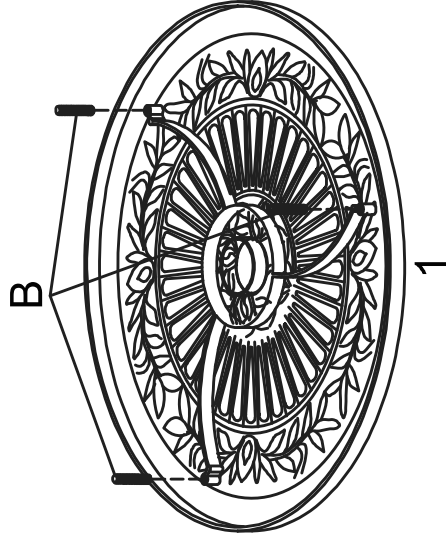

(B) X3

3

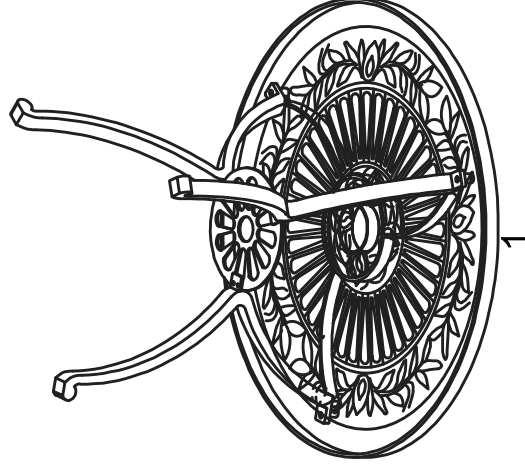

(G) X3 (I) X3
(H) X3 (J) X3

