



Ceiling Fan Manual



To Dear Customer

Congratulations on your purchase of the new ceiling fan

It's a great honor for you choose our product, please read the manual carefully before installation. Please also feel free to contact our professional customer service for assistance if you have any questions or product problems, thank you!

w w w . p m w f a n . c o m

Ceiling Fan

Installation Manual

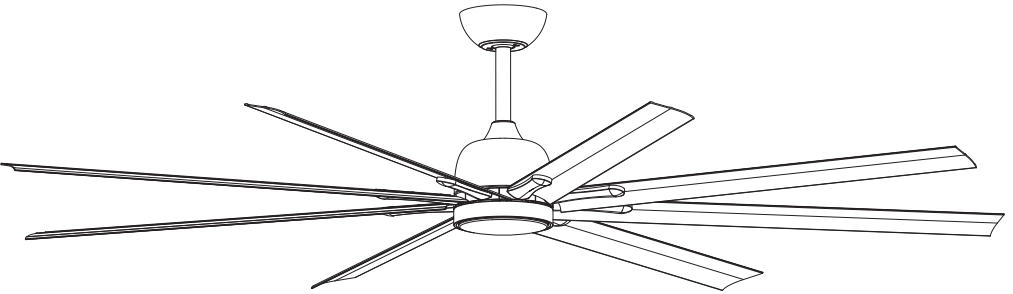

THANK YOU

We appreciate the trust and confidence you have placed in us through the purchase of this ceiling fan. We strive to continually create quality products designed to enhance your home. Thank you for choosing us!

Visit www.pmwfan.com for further assistance.

SAFETY INFORMATION

The information contained in the following pages has been prepared to ensure your maximum enjoyment of your fan. Please remove the fuse or turn off the circuit breaker to cut off the power before installing the fan. Ensure all electrical connections are in compliance with local laws, regulations and national electrical codes. If you are not familiar with electrical installation and wiring, please hire a qualified electrician or consult the wiring manual.

1. For your safety, all electrical connections and disconnections should be performed by a qualified electrician.
2. Any action performed for the electrical connection of the device must be carried out after ensuring that the general power supply is disconnected by removing the corresponding fuse or disarming the protective switch in order to ensure total isolation of the power supply.
3. When deciding where to mount the fan, be sure that there is at least 50 cm of space between the fan and any wall or other obstruction that the fan blades could collide with. The greater this distance, the more effective the air flow produced. After the fan is mounted, be sure that the blades are no less than 2.3 m above the ground.
4. The anchor point for the fan must be able to support a weight of at least 45 kgs. If mounting on a ceiling junction box, be sure that the fan is adequately supported to prevent loosening or turning.
5. The fan's electrical connection must be "grounded" (the fan's ground cable connected to the installation's grounding network) in order to avoid any branching that may be dangerous to people.
6. Do not connect the fan's power supply to any dimmers, potentiometers, or light switches, as it will cause the fan to malfunction and/or will damage the motor. The fan must be directly connected to a properly protected installation circuit (magneto-thermal differential switch with the adequate size for the fan's consumption and technical specifications). Only use the fan's control to turn it on or stop it.
7. It is recommended to not use these types of fans along with gas installations simultaneously in the same room.
8. The fan must be not be moving and must have come to a complete stop before changing its direction of rotation. This will prevent damage to its motor and to the control unit, when applicable.
9. Do not insert anything that could hit the fan's blades into its pathway while it is moving, as this could cause damage to people, can damage the blades, and can offset the balance of the unit, causing vibrations and wobbling.
10. After installing the fan, ensure that all fastenings are secure and tightened in order to avoid any noise caused by loose elements.
11. Due to the fan's movement, certain fastenings may become loose. Check all fastenings twice per year at a minimum in order to ensure that they are sufficiently tight. If necessary, they must be retightened.
12. The motor housing can be cleaned with a soft brush or a lint-free cloth to avoid scratching the surface. Clean the blades with a lint-free cloth. Important: Turn off the main power supply before starting any maintenance. Do not clean the fans with water or a damp cloth.
13. The fan can only operate normally after all blades are installed. If the fan is turned on without installing the blades, the receiver will detect that the fan speed is too fast and it will "Beep Beep". Then the fan will stop.
14. The light source contained in this luminaire shall only be replaced by the manufacturer or his service agent or a similar qualified person.
15. If unusual oscillating movement is observed, immediately stop using the ceiling fan and contact the manufacturer, its service agent or suitably qualified persons.
16. The replacement of parts of the safety suspension system device shall be performed by the manufacturer, its service agent or suitably qualified persons.
17. The fixing means for attachment to the ceiling such as hooks or other devices shall be fixed with a sufficient strength to withstand 4 times the weight of the ceiling fan.
18. It is recommended to inspect the connecting components of the fan at least once a year, including the horizontal pin, blade holder, hanger connection screws, and fan blades, to ensure that the product connections are still safe and reliable.

Battery WARNING:

- Keep out of reach of children. Swallowing can lead to chemical burns, perforation of soft tissue and death. Severe burns can occur within 2 h of ingestion. Seek medical attention immediately.
 - If used incorrectly or if the battery is damaged, flammable liquid may be ejected from the battery. Contact with this liquid should be avoided. If contact accidentally occurs, rinse off with water. If the liquid comes into contact with your eyes, seek additional medical attention. Liquid ejected from the battery may cause irritation or burns.
 - Do not expose the appliance or battery to excessive temperatures.
 - Be aware of the risk of terminals of the battery-operated appliance or battery being short-circuited by metal objects.
 - Do not use modified or damaged batteries.
 - Non-rechargeable batteries are not to be recharged.
 - Different types of batteries or new and used batteries are not to be mixed.
 - Batteries are to be inserted with the correct polarity;
 - Exhausted batteries are to be removed from the appliance and safely disposed of.
 - If the appliance is to be stored unused for a long period, the batteries should be removed.
- Battery: 1.5V*2AAA

Note: The important warnings and instructions indicated in this manual are not guaranteed to cover all possible conditions and situations that may occur. It must be understood that common sense, precaution, and care are factors that cannot be included in all products. These factors can and must only be provided by the user who maintains and enjoys this fan.

DIMENSIONS

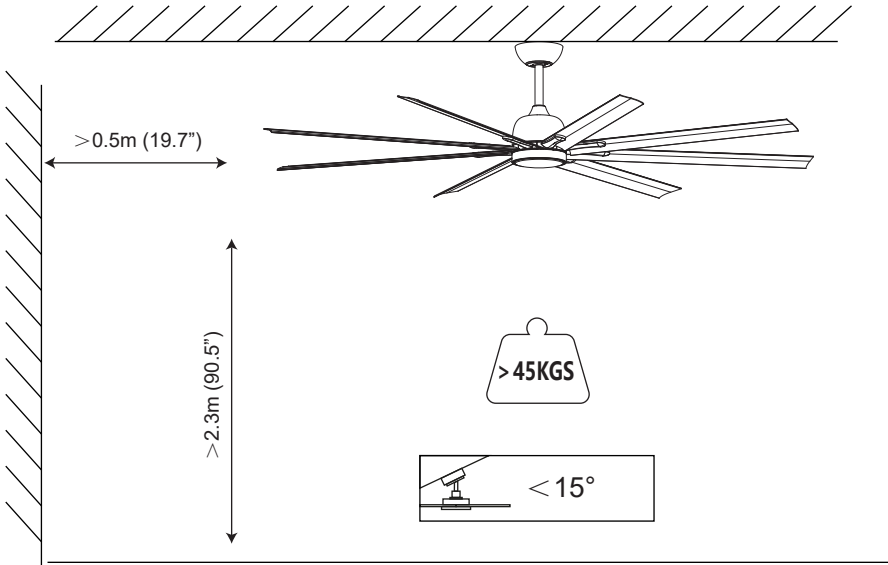

TOOLS REQUIRED



Step
ladder



pliers

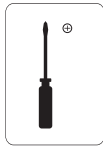

Phillips
screwdriver

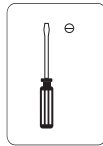

Flat blade
screwdriver



Electrical
tape



tape
measure

PACKING LIST



Before unpacking the fan, please check that all parts are included, as listed below:



1.Bracket



6.Light Fixture



2.Canopy

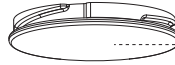

7.Lampshade

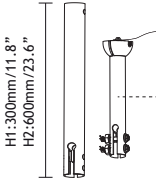

3.Downrod

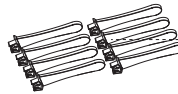

8.Blade arm



4.Coupling cover

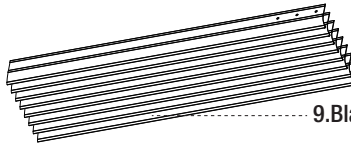

9.Blades

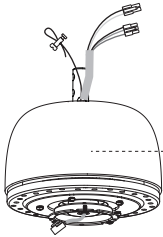

5.Motor Assembly

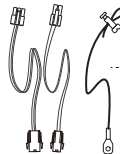

10. Spare power cable
Spare safety rope

Remote control unit

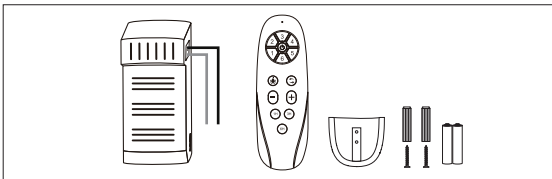

Blade balance kit

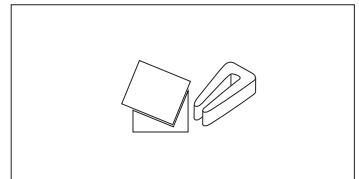

Hardware bag

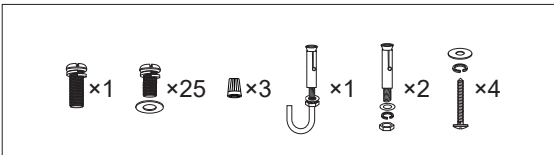

Installation manual

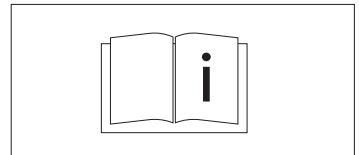

• Note: The illustrations in this manual are for explanatory purposes only and may not correspond to actual units.

HANGING BRACKET INSTALLATION

- Before starting any work, make sure that the power to the main power cabinet is safely turned off. This can be done by either removing the fuse or switching off the circuit breaker.



- Make sure that ceiling joists are strong enough and of adequate size to support the weight of the fan of about 45 kg.
- Use different screws to fix the bracket according to the ceiling material. Can be installed on <math><15^\circ</math> sloped roof.

- ① remove two screws from the bracket (without fully removing them).

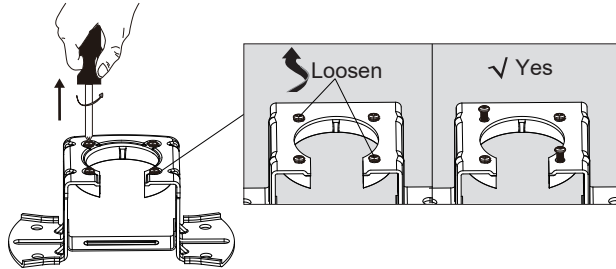

- ② Use different screws to secure the bracket according to the ceiling material.

Concrete ceiling

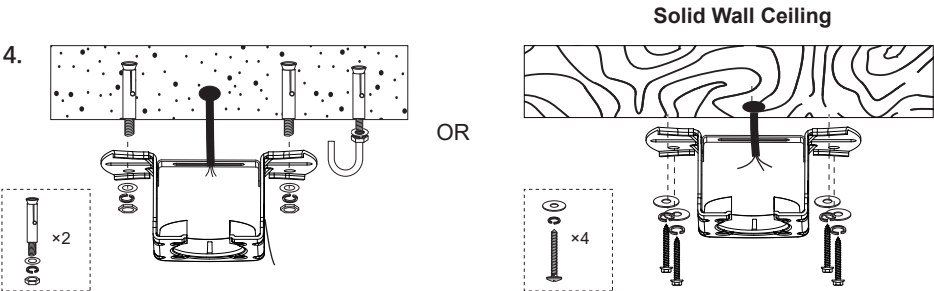
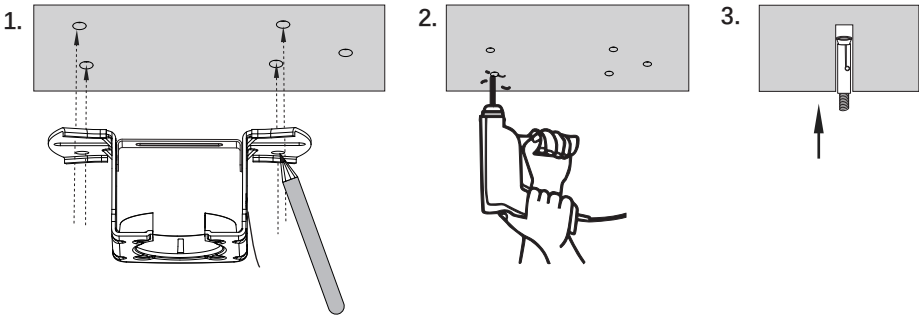

OR



Check whether bracket is securely installed or not.

BASIC ASSEMBLY OF THE FAN

① Detach the downrod assembly.

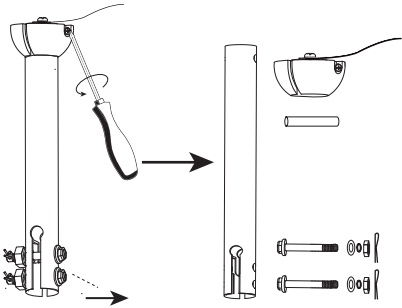

② Remove the pre-installed screws from the motor assembly.

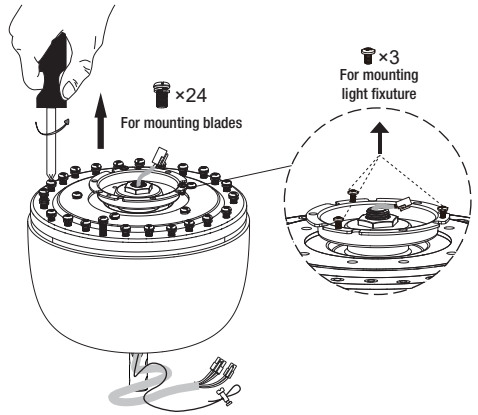

Importance: If you are going to use a long down rod, follow these steps.

- 1. Connecting the Spare Power Cable
- 2. Connecting the Spare Safety rope

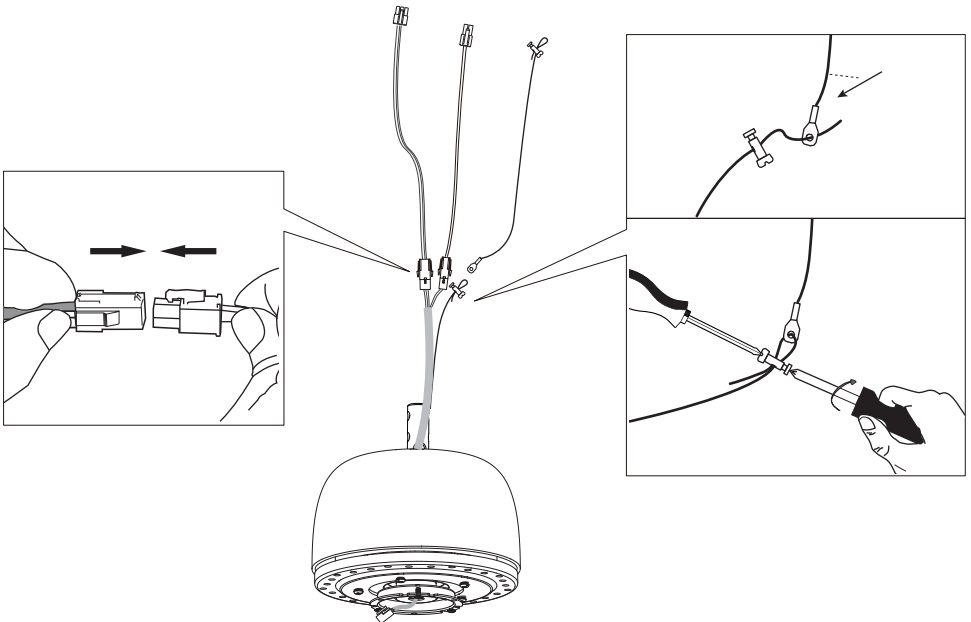

- ③ Loosen the two screws on the coupling. Route the wires through the downrod. Align the holes at the bottom of the downrod with the holes in the coupling. Ensure the bolt passes through the holes in the coupling and downrod. Secure the downrod to the coupling with bolt, washer, nut, tighten the nut, and tighten the mfirmly. Finally, tighten the two screws on the coupler.

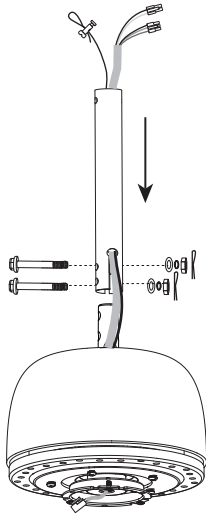

- ④ Insert the cover, canopy cover, canopy and the ball onto the downrod in the correct order. insert the cross pin into the holes to the top of downrod to ensure it is properly installed in the slot. and then align the holes and tigen the two screws.

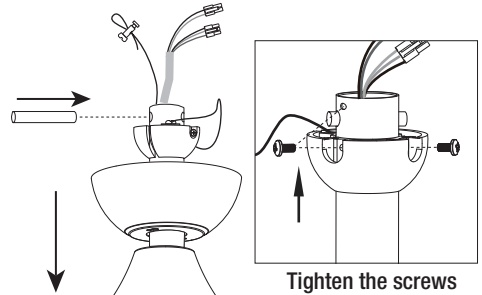

- ⑤ Assemble the blades and blade arms.

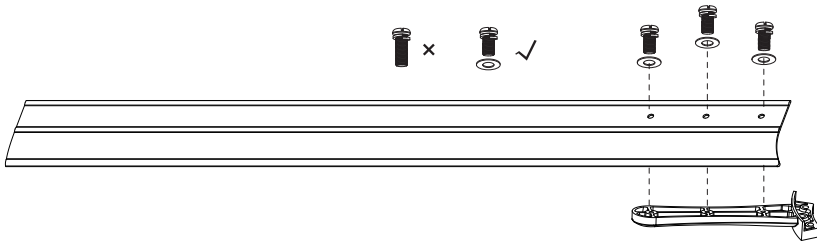

- ⑥ Lift motor assembly onto mounting bracket. Install the ball joint onto the mounting bracket opening. Rotate fan until notch on downrod ball engages the ridge on the mounting bracket.

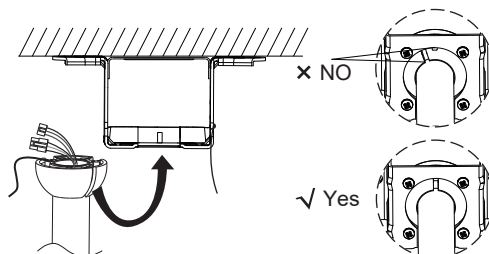

⑦ Safety rope installation.

Secure the bracket with appropriate screws according to the actual condition of the ceiling.

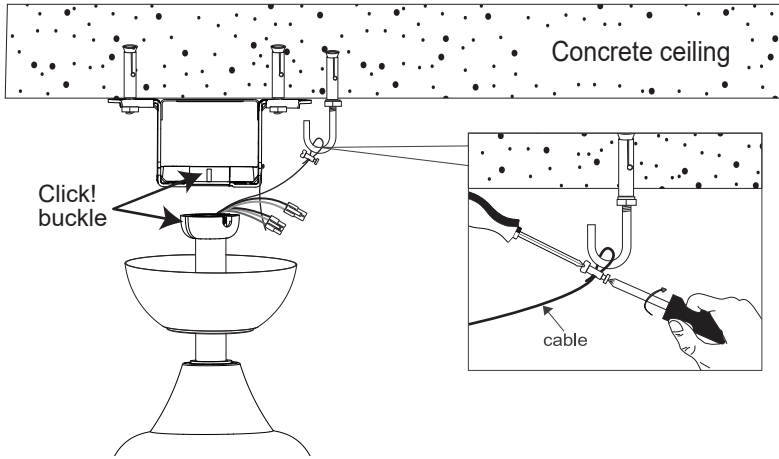

OR

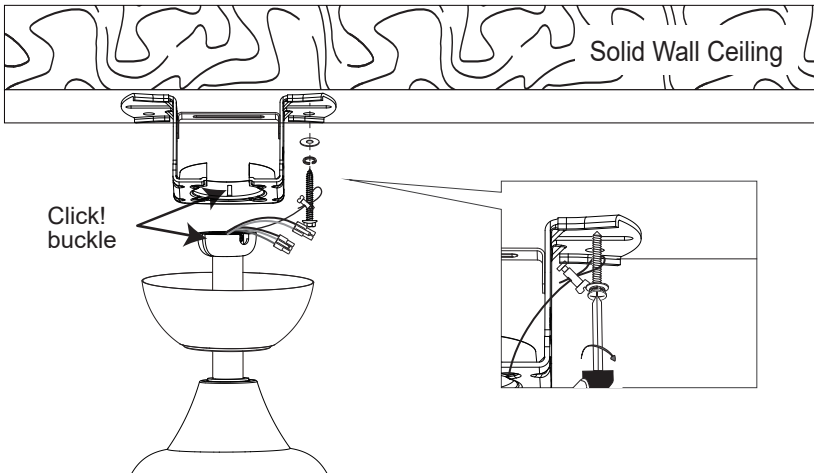

⑧ Put the receiver into the bracket.

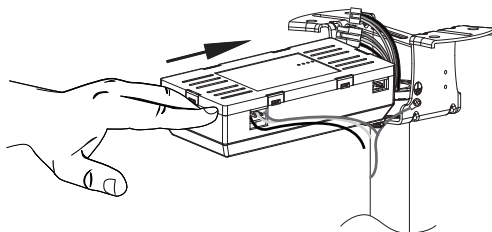

WIRING

- 1 Wire in accordance with the wiring diagram



If you are not familiar with wiring or have any doubts, please consult an electrician.

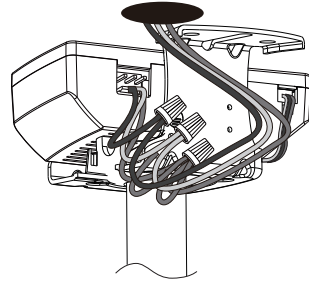

WIRING DIAGRAMS

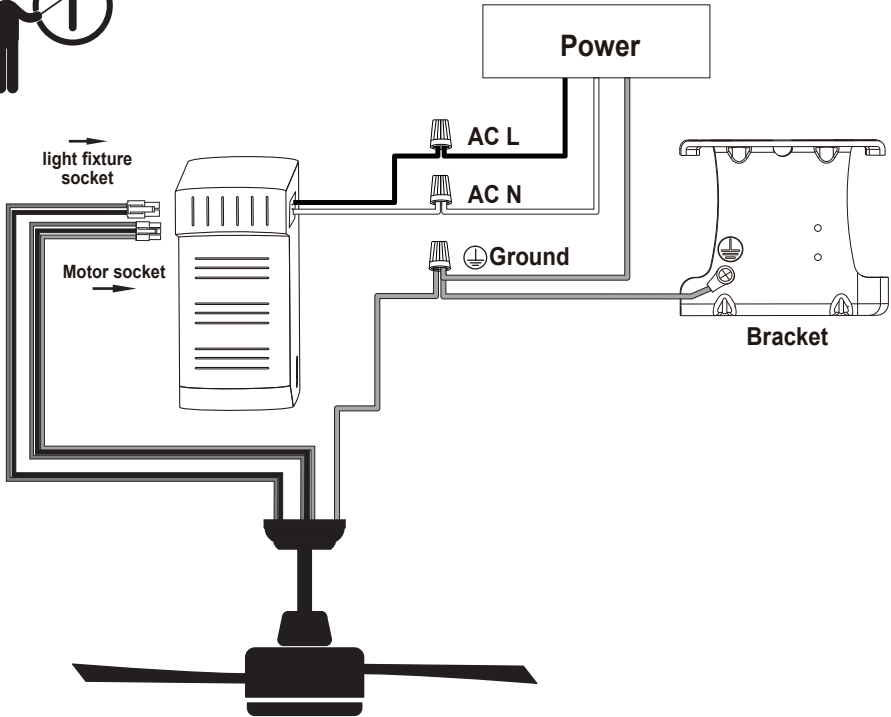

MOUNTING REMAINING PARTS

- 1 Slide the canopy upwards towards the bracket and align the holes with the screws. Rotate the canopy clockwise until it locks into place, then tighten the screws.

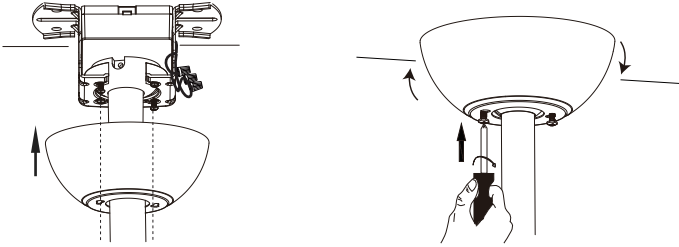

- 2 Align the holes on the blade arms with the corresponding ones on the motor assembly. Then, use the blade arm screws to secure the blades in place and tighten them. Repeat this step until all blades are installed.

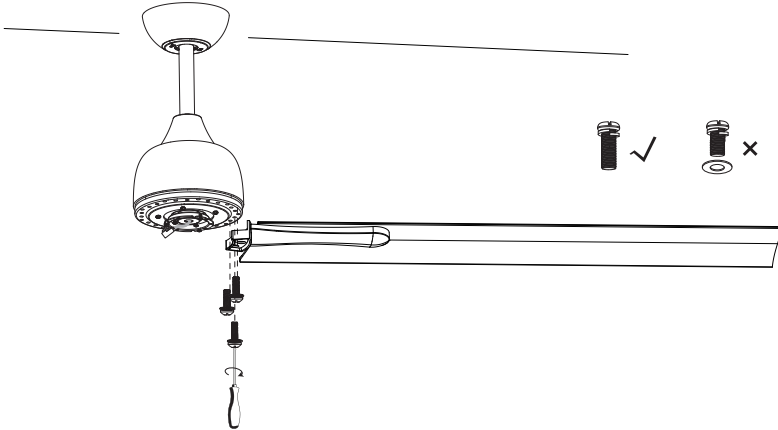

- 3 Align the holes on the light fixture with the corresponding holes on the motor assembly, then connect the wiring terminals. Use the 3 screws you removed to install the light fixture onto the motor assembly.

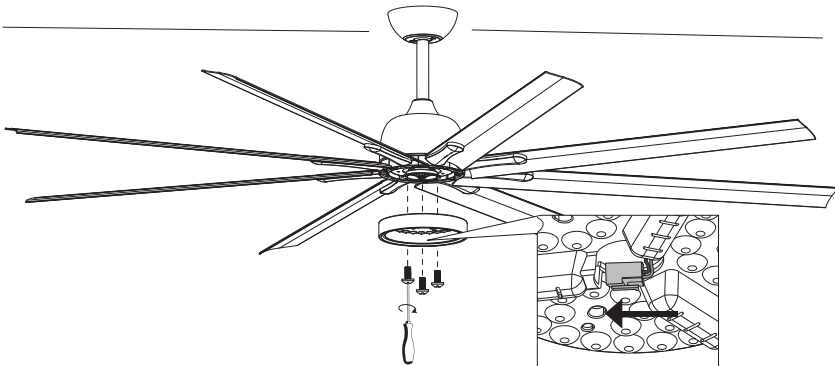

- ④ Align the slot on the lampshade with the clip on the light. Rotate the lampshade until it is securely fixed in place.

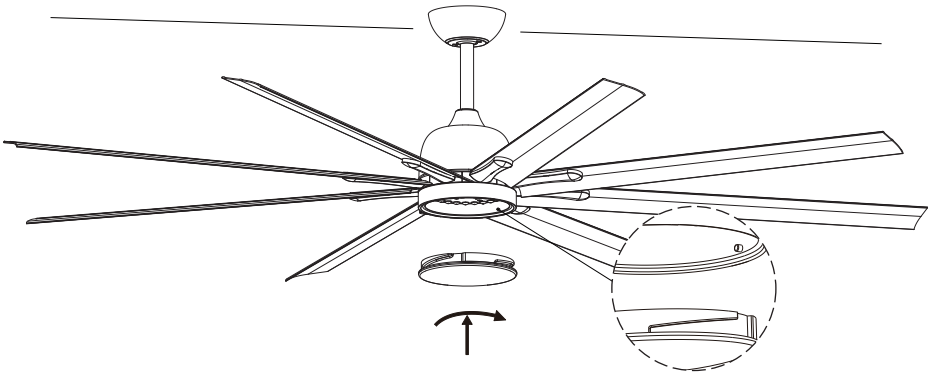

START THE FAN

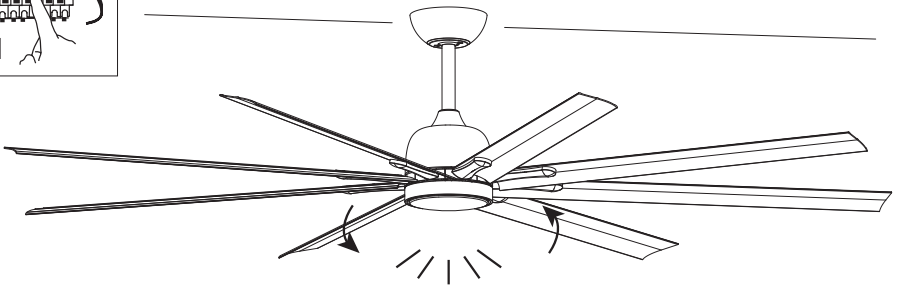
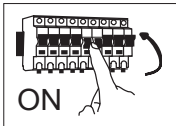

REMOTE CONTROL OPERATION

Button Function

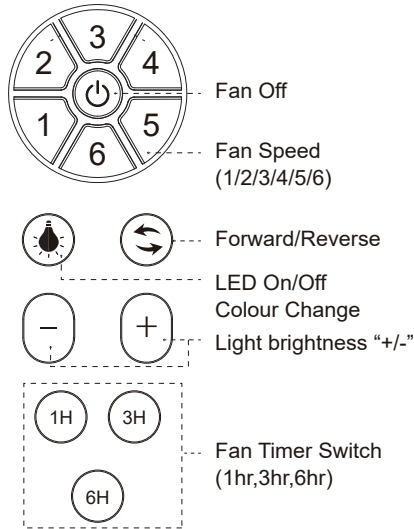

Remote Control Pairing

• **NOTE:** Your remote control has been factory pre-set, so no pairing is required for first-time use. Re-pairing is only necessary if the remote control malfunctions.

1. Install 2 batteries into the remote controller.
2. Turn on the power. Within 10 seconds of powering on the fan, press and hold the "1" and "2" buttons for about 3 seconds. After a beeping sound, pairing is complete, and the fan is ready for use.

About the light memory function : Turn on the light and wait for 3-5 seconds while maintaining the desired color. Then turn off the light and wait at least 10 seconds before turning it back on. The light color will be saved as your preference.

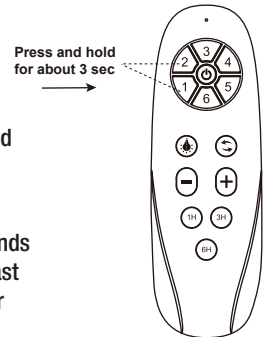

Installing Wall-Mounted Remote Control Holder

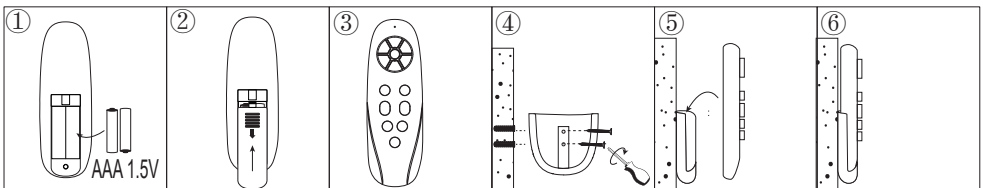

TROUBLESHOOTING



WARNING: Make sure the power is off at the electrical panel box before you attempt any repairs.

Problem	Solution
The fan will not start.	<input type="checkbox"/> Check the main and branch circuit fuses or breakers.
	<input type="checkbox"/> Check the line wire connections to the fan and switch wire connections in the switch housing.
	<input type="checkbox"/> Check to make sure the frequency switches from the remote control and receiver are set to the same frequency.
The fan sounds noisy.	<input type="checkbox"/> Make sure all motor housing screws are snug.
	<input type="checkbox"/> Make sure the screws that attach the fan blade to the motor hub are tight.
	<input type="checkbox"/> Make sure the wire nut connections are not rattling against each other or the interior wall of the switch housing.
	<input type="checkbox"/> Allow a 24-hour "breaking-in" period. Most noises associated with a new fan disappear during this time.
	<input type="checkbox"/> If using the ceiling light kit, make sure the glassware is secured tightly.
	<input type="checkbox"/> Make sure there is a short distance from the ceiling to the canopy. It should not touch the ceiling.
The remote control is not working.	<input type="checkbox"/> Make sure your ceiling box is secure and that rubber isolator pads are used between the mounting bracket and outlet box.
	<input type="checkbox"/> Make sure the frequency switches are set correctly.

Balancing – Wobbling problems during fan operation

If the fan body wobbles during its operation, this is not a sign of malfunctioning (even if it wobbles a few centimeters). To reduce wobbling, you can turn off the fan, and:

1. Check that all blades are properly fastened by tightening their screws.
2. Check the distance between each blade and the ceiling. Measurements to the ceiling can be carried out as shown in the following diagram. If variations exist and you have already correctly tightened the screws, check that all blades have the same shape. If any of them have a shape that is visibly different, this may be causing an imbalance during fan operation.

If you have completed the previous steps and the wobbling has not resolved, you should apply dynamic balancing with the kit provided, as explained below:

1. Turn the fan on to the highest speed so that the greatest amount of wobbling is produced.
2. Turn off the fan. Select a blade and place a clip on it (see diagram) halfway between the fastening and the far edge of the blade.
3. Turn on the fan and check whether the wobbling has improved or gotten worse. Turn it off once again and if the wobbling has not improved, place the clip on another blade. Repeat this process and determine on which blade it improves the wobbling.
4. Leave the clip on the blade that produces the best results. Move the clip forward or backwards on this blade until finding the position that offers the best results.
5. Afterwards, remove the clip and place one of the weights on the upper part of the center line of the blade at the position where the clip was located.

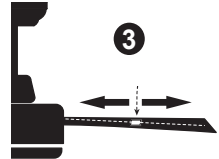
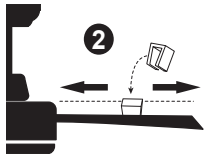
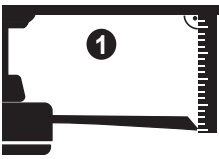

Ceiling Fan

Questions, problems, missing parts? Before returning to the store,
visit www.pmwfan.com for further assistance.

Retain this manual for future use.

Manufacturer: Zhongshan Miaowang Electrical Appliance Co., Ltd.

Address: Building C, No.10, Qingfu Road, Henglan Town, Zhongshan City, Guangdong Province,CN

Website: www.pmwfan.com

Tech Support Telephone: +12092272409

Tech Support Email Address: support@pmwfan.com