

# Portable Air Conditioner CF

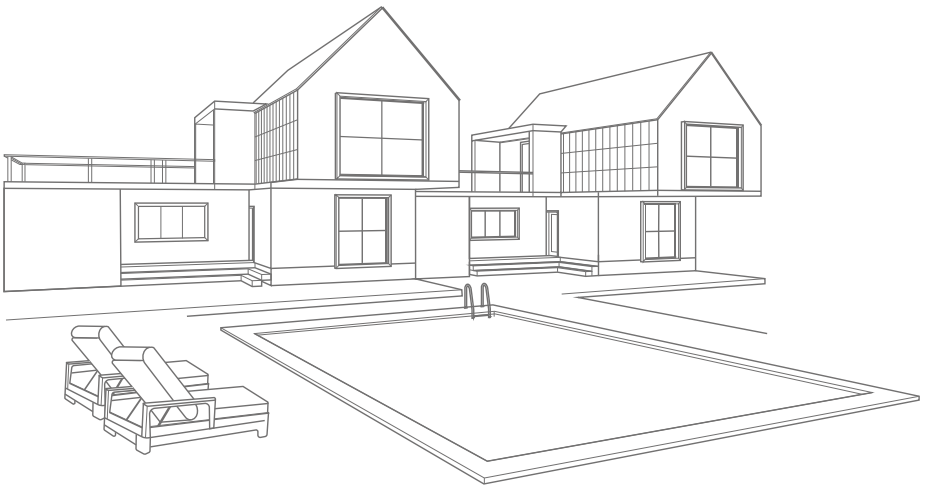

Product ID. QCDEA

Scan for Support  
[support@garvee.com](mailto:support@garvee.com)



**GARVEE.com**



# CONTENTS

■ Important Safety Instructions .....	01
■ Features and Components .....	11
■ Control Setting .....	14
■ Protection Function .....	17
■ Installation and Adjustment .....	18
■ Drainage Instructions .....	21
■ Maintenance .....	22
■ Unit Storage .....	23
■ Troubleshooting .....	24
■ Appendix .....	25



## Precautions for using R32 refrigerant

Please read the instructions before use and repair.

The drawings provided in this manual may not be the same as the physical objects.

Please refer to the physical objects.

## ■ ■ Important Safety Instructions

### 1.1 General Safety Instructions

- Follow local grid interconnection rules while installing the air conditioner and ensure that it is properly grounded. If you have any question on electrical installation, follow the instructions of the manufacturer, and if necessary, ask a professional electrician to install it.
- Do not install and use the air conditioner in the bathroom or other humid environments.
- Place the machine in a flat and dry place and keep a distance of above 50cm between the machine and the surrounding objects or walls.
- When drainage pipes are installed, ensure that the drainage pipes are properly connected, and are not distorted or bended.
- Keep the air inlet and outlet free from obstructions.
- The appliance shall be installed in accordance with national wiring regulations.
- After the air conditioner is installed, ensure that the power plug is intact and firmly plugged into the power outlet, and place the power cord orderly to prevent someone from being tripped or pulling out the plug.
- Do not put any object into the air inlet and outlet of the air conditioner.
- Maintenance and repair requiring the assistance of other skilled personnel shall be carried out under the supervision of the person competent in the use of flammable refrigerants.
- All working procedure that affects safety means shall only be carried by competent persons. Examples for such working procedures are: • breaking into the refrigerating circuit; • opening of sealed components; • opening of ventilated enclosures. (DD.3.3) The air conditioner is only suitable for indoor use, and is not suitable for other applications.
- While adjusting the upper and lower wind-guide strips of the air outlet, pluck it with hands gently to avoid damaging wind-guide strips.
- When moving the machine, make sure that it is in an upright position.
- The machine should stay away from gasoline, flammable gas, stoves and other heat sources.
- Don't disassemble, overhaul and modify the machine arbitrarily, otherwise it will cause a machine malfunction or even bring harm to persons and properties. To avoid danger, if a machine failure occurs, ask the manufacturer or professionals to repair it.

- Do not pull the plug to turn off the machine.
- Do not place cups or other objects on the body to prevent water or other liquids from spilling into the air conditioner.
- Do not use insecticide sprays or other flammable substances near the air conditioner.
- Do not wipe or wash the air conditioner with chemical solvents such as gasoline and alcohol. When you need to clean the air conditioner, you must disconnect the power supply, and clean it with a half-wet soft cloth. If the machine is really dirty, scrub with a mild detergent.
- Children shall not play with the appliance. Cleaning and maintenance shall not be made by children without supervision.
- If the supply cord is damaged, it must be replaced by the manufacturer, its service agent or similarly qualified persons in order to avoid a hazard.
- The appliance shall be stored so as to prevent mechanical damage from occurring.
- Plug into a grounded 3 prong outlet
- Do not use an extension cord
- Do not remove ground prong
- Do not use an electrical adapter
- Unplug the air conditioner before servicing

## **1.2 Special Safety Instructions for using flammable refrigerant**

### **1. Transport of equipment containing flammable refrigerants**

Compliance with the transport regulations

### **2. Marking of equipment using signs**

Compliance with local regulations

### **3. Disposal of equipment using flammable refrigerants**

Compliance with national regulations

### **4. Storage of equipment/appliances**

The storage of equipment should be in accordance with the manufacturer's instructions.

### **5. Storage of packed (unsold) equipment**

- Storage package protection should be constructed such that mechanical damage to the equipment inside the package will not cause a leak of the refrigerant charge.
- The maximum number of pieces of equipment permitted to be stored together will be determined by local regulations.

### **6. Information on servicing**

#### **6-1 Checks to the area (DD.4.2)**

- Prior to beginning work on systems containing flammable refrigerants, safety checks are necessary to ensure that the risk of ignition is minimised.
- For repair to the refrigerating system, the following precautions shall be complied with prior to conducting work on the system.

### **6-2 Work procedure (DD.4.3)**

Work shall be undertaken under a controlled procedure so as to minimise the risk of a flammable gas or vapour being present while the work is being performed.

### **6-3 General work area (DD.4.4)**

- All maintenance staff and others working in the local area shall be instructed on the nature of work being carried out. Work in confined spaces shall be avoided.
- The area around the workspace shall be sectioned off. Ensure that the conditions within the area have been made safe by control of flammable material.

### **6-4 Checking for presence of refrigerant (DD.4.5)**

- The area shall be checked with an appropriate refrigerant detector prior to and during work, to ensure the technician is aware of potentially flammable atmospheres.
- Ensure that the leak detection equipment being used is suitable for use with flammable refrigerants, i.e. non-sparking, adequately sealed or intrinsically safe.

### **6-5 Presence of fire extinguisher (DD.4.6)**

- If any hot work is to be conducted on the refrigeration equipment or any associated parts, appropriate fire extinguishing equipment shall be available to hand.
- Have a dry powder or CO2 fire extinguisher adjacent to the charging area.

### **6-6 No ignition sources (DD.4.7)**

- No person carrying out work in relation to a refrigeration system which involves exposing any pipe work that contains or has contained flammable refrigerant shall use any sources of ignition in such a manner that it may lead to the risk of fire or explosion.
- All possible ignition sources, including cigarette smoking, should be kept sufficiently far away from the site of installation, repairing, removing and disposal, during which flammable refrigerant can possibly be released to the surrounding space.
- Prior to work taking place, the area around the equipment is to be surveyed to make sure that there are no flammable hazards or ignition risks. "No Smoking" signs shall be displayed.

### **6-7 Ventilated area**

Ensure that the area is in the open or that it is adequately ventilated before breaking into the system or conducting any hot work.

A degree of ventilation shall continue during the period that the work is carried out. The ventilation should safely disperse any released refrigerant and preferably expel it externally into the atmosphere.

### **6-8 Checks to the refrigeration equipment (DD.4.9)**

- Where electrical components are being changed, they shall be fit for the purpose and to the correct specification.
- At all times the manufacturer's maintenance and service guidelines shall be followed. If in doubt consult the manufacturer's technical department for assistance.

- The following checks shall be applied to installations using flammable refrigerants:
  - The charge size is in accordance with the room size within which the refrigerant containing parts are installed;
  - The ventilation machinery and outlets are operating adequately and are not obstructed;
  - If an indirect refrigerating circuit is being used, the secondary circuit shall be checked for the presence of refrigerant;
  - Marking to the equipment continues to be visible and legible. Markings and signs that are illegible shall be corrected;
  - Refrigeration pipe or components are installed in a position where they are unlikely to be exposed to any substance which may corrode refrigerant containing components, unless the components are constructed of materials which are inherently resistant to being corroded or are suitably protected against being so corroded.

### **6-9 Checks to electrical devices**

- Repair and maintenance to electrical components shall include initial safety checks and component inspection procedures.
- If a fault exists that could compromise safety, then no electrical supply shall be connected to the circuit until it is satisfactorily dealt with.
- If the fault cannot be corrected immediately but it is necessary to continue operation, an adequate temporary solution shall be used.
- This shall be reported to the owner of the equipment so all parties are advised.
- Initial safety checks shall include:
  - That capacitors are discharged: this shall be done in a safe manner to avoid possibility of sparking;
  - That there no live electrical components and wiring are exposed while charging, recovering or purging the system;
  - That there is continuity of earth bonding.

### **7. Repairs to sealed components**

- During repairs to sealed components, all electrical supplies shall be disconnected from the equipment being worked upon prior to any removal of sealed covers, etc.
- If it is absolutely necessary to have an electrical supply to equipment during servicing, then a permanently operating form of leak detection shall be located at the most critical point to warn of a potentially hazardous situation.
- Particular attention shall be paid to the following to ensure that by working on electrical components, the casing is not altered in such a way that the level of protection is affected.
- This shall include damage to cables, excessive number of connections, terminals not made to original specification, damage to seals, incorrect fitting of glands, etc.
- Ensure that apparatus is mounted securely.
- Ensure that seals or sealing materials have not degraded such that they no longer serve the purpose of preventing the ingress of flammable atmospheres.
- Replacement parts shall be in accordance with the manufacturer's specifications.

**NOTE:**

The use of silicon sealant may inhibit the effectiveness of some types of leak detection equipment. Intrinsically safe components do not have to be isolated prior to working on them.

**8. Repair to intrinsically safe components (DD.5/DD.6)**

- Do not apply any permanent inductive or capacitance loads to the circuit without ensuring that this will not exceed the permissible voltage and current permitted for the equipment in use.
- Intrinsically safe components are the only types that can be worked on while live in the presence of a flammable atmosphere. The test apparatus shall be at the correct rating.
- Replace components only with parts specified by the manufacturer.
- Other parts may result in the ignition of refrigerant in the atmosphere from a leak.

**9. Cabling (DD.7)**

- Check that cabling will not be subject to wear, corrosion, excessive pressure, vibration, sharp edges or any other adverse environmental effects.
- The check shall also take into account the effects of aging or continual vibration from sources such as compressors or fans.

**10. Detection of flammable refrigerants (DD.8)**

- Under no circumstances shall potential sources of ignition be used in the searching for or detection of refrigerant leaks.
- A halide torch (or any other detector using a naked flame) shall not be used.

**11. Leak detection methods (DD.8)**

- The following leak detection methods are deemed acceptable for systems containing flammable refrigerants:
  - Electronic leak detectors shall be used to detect flammable refrigerants, but the sensitivity may not be adequate, or may need re-calibration. (Detection equipment shall be calibrated in a refrigerant-free area.)
  - Ensure that the detector is not a potential source of ignition and is suitable for the refrigerant used.
  - Leak detection equipment shall be set at a percentage of the LFL of the refrigerant and shall be calibrated to the refrigerant employed and the appropriate percentage of gas (25 % maximum) is confirmed.
  - Leak detection fluids are suitable for use with most refrigerants but the use of detergents containing chlorine shall be avoided as the chlorine may react with the refrigerant and corrode the copper pipe-work.
  - If a leak is suspected, all naked flames shall be removed/ extinguished.

- If a leakage of refrigerant is found which requires brazing, all of the refrigerant shall be recovered from the system, or isolated (by means of shut off valves) in a part of the system remote from the leak.
- Oxygen free nitrogen (OFN) shall then be purged through the system both before and during the brazing process.

## **12. Removal and evacuation**

- When breaking into the refrigerant circuit to make repairs – or for any other purpose – conventional procedures shall be used. However, for flammable refrigerants it is important that the best practice is followed since flammability is a consideration. Opening of the refrigeration systems shall not be done by brazing.
- The following procedure shall be adhered to:
  - Remove refrigerant;
  - Purge the circuit with inert gas;
  - Evacuate;
  - Purge again with inert gas;
  - Open the circuit by cutting or brazing.
- The refrigerant charge shall be recovered into the correct recovery cylinders.
- The system shall be “flushed” with OFN to render the unit safe.
- This process may need to be repeated several times.
- Compressed air or oxygen shall not be used for this task.
- Flushing shall be achieved by breaking the vacuum in the system with OFN and continuing to fill until the working pressure is achieved, then venting to atmosphere, and finally pulling down to a vacuum.
- This process shall be repeated until no refrigerant is within the system. When the final OFN charge is used, the system shall be vented down to atmospheric pressure to enable work to take place.
- This operation is absolutely vital if brazing operations on the pipe-work are to take place.
- Ensure that the outlet for the vacuum pump is not close to any ignition sources and there is ventilation available.

## **13. Charging procedures**

- In addition to conventional charging procedures, the following requirements shall be followed:
  - Ensure that contamination of different refrigerants does not occur when using charging equipment.
  - Hoses or lines shall be as short as possible to minimise the amount of refrigerant contained in them.
  - Cylinders shall be kept upright.
  - Ensure that the refrigeration system is earthed prior to charging the system with refrigerant.
  - Label the system when charging is complete (if not already).
  - Extreme care shall be taken not to overfill the refrigeration system.

- Prior to recharging the system it shall be pressure tested with OFN.
- The system shall be leak tested on completion of charging but prior to commissioning.
- A follow up leak test shall be carried out prior to leaving the site.

#### **14. Decommissioning (DD.10)**

- Before carrying out this procedure, it is essential that the technician is completely familiar with the equipment and all its detail.
- It is recommended good practice that all refrigerants are recovered safely.
- Prior to the task being carried out, an oil and refrigerant sample shall be taken in case analysis is required prior to re-use of reclaimed refrigerant. It is essential that electrical power is available before the task is commenced.
  - a) Become familiar with the equipment and its operation.
  - b) Isolate system electrically.
  - c) Before attempting the procedure ensure that:
    - Mechanical handling equipment is available, if required, for handling refrigerant cylinders;
    - All personal protective equipment is available and being used correctly;
    - The recovery process is supervised at all times by a competent person;
    - Recovery equipment and cylinders conform to the appropriate standards.
  - d) Pump down refrigerant system, if possible.
  - e) If a vacuum is not possible, make a manifold so that refrigerant can be removed from various parts of the system.
  - f) Make sure that cylinder is situated on the scales before recovery takes place.
  - g) Start the recovery machine and operate in accordance with manufacturer's instructions.
  - h) Do not overfill cylinders. (No more than 80 % volume liquid charge).
  - i) Do not exceed the maximum working pressure of the cylinder, even temporarily.
  - j) When the cylinders have been filled correctly and the process completed, make sure that the cylinders and the equipment are removed from site promptly and all isolation valves on the equipment are closed off.
  - k) Recovered refrigerant shall not be charged into another refrigeration system unless it has been cleaned and checked.

#### **15. Labelling (DD.12)**

- Equipment shall be labelled stating that it has been de-commissioned and emptied of refrigerant.
- The label shall be dated and signed.
- Ensure that there are labels on the equipment stating the equipment contains flammable refrigerant.

#### **16. Recovery(D.13)**

- When removing refrigerant from a system, either for servicing or decommissioning, it is recommended good practice that all refrigerants are removed safely.

- When transferring refrigerant into cylinders, ensure that only appropriate refrigerant recovery cylinders are employed.
  - Ensure that the correct number of cylinders for holding the total system charge is available.
  - All cylinders to be used are designated for the recovered refrigerant and labelled for that refrigerant (i.e. special cylinders for the recovery of refrigerant).
  - Cylinders shall be complete with pressure relief valve and associated shut-off valves in good working order.
  - Empty recovery cylinders are evacuated and, if possible, cooled before recovery occurs.
  - The recovery equipment shall be in good working order with a set of instructions concerning the equipment that is at hand and shall be suitable for the recovery of flammable refrigerants.
  - In addition, a set of calibrated weighing scales shall be available and in good working order.
  - Hoses shall be complete with leak-free disconnect couplings and in good condition.
  - Before using the recovery machine, check that it is in satisfactory working order, has been properly maintained and that any associated electrical components are sealed to prevent ignition in the event of a refrigerant release.
  - Consult manufacturer if in doubt.
  - The recovered refrigerant shall be returned to the refrigerant supplier in the correct recovery cylinder, and the relevant Waste Transfer Note arranged.
  - Do not mix refrigerants in recovery units and especially not in cylinders.
  - If compressors or compressor oils are to be removed, ensure that they have been evacuated to an acceptable level to make certain that flammable refrigerant does not remain within the lubricant.
  - The evacuation process shall be carried out prior to returning the compressor to the suppliers.
  - Only electric heating to the compressor body shall be employed to accelerate this process.
  - When oil is drained from a system, it shall be carried out safely.
- **This appliance is not intended for use by persons (including children) with reduced physical, sensory or mental capabilities, or lack of experience and knowledge, unless they have been given supervision or instruction concerning use of the appliance by a person responsible for their safety. Children should be supervised to ensure that they do not play with the appliance.**
- **When moving or relocating the air conditioner, consult experienced service technicians for disconnection and reinstallation of the unit.**
  - **Do not place any other electrical products or household belongings under the unit. Condensation dripping from the unit might get them wet, and may cause damage or malfunction of your property.**

- To keep ventilation openings clear of obstruction.
- The appliance shall be stored in a well-ventilated area where the room size corresponds to the room area as specified for operation.
- The appliance shall be stored in a room without continuously operating open flames (for example: an operating gas appliance ) and ignition sources (for example operating electric heater).
- Any person who is involved with working on or breaking into a refrigerant circuit should hold a current valid certificate from an industry-accredited assessment authority, which authorises their competence to handle refrigerants safely in accordance with an industry recognised assessment specification.
- Servicing shall only be performed as recommended by the equipment manufacturer.
- Maintenance and repair requiring the assistance of other skilled personnel shall be carried out by the person competent in the use of flammable refrigerants.
- The pipe-work shall be complied with national gas regulations.
- The maximum refrigerant charge amount is 0.45kg.
- The installation of pipe-work shall be kept to minimum.

If the refrigerant is flammable the air conditioning equipment shall have red, Pantone® Matching System (PMS) #185 marked service ports, pipes, hoses, and other devices through which the refrigerant is serviced. This colour shall be present at all service ports and where service puncturing or otherwise creating an opening from the refrigerant circuit to the atmosphere might be expected (e.g., process tubes). The colour mark shall extend at least 25 mm (1 inch) from the refrigerant servicing point and shall be replaced if removed (DD.2)



**Caution, risk of fire**

### **WARNING**

- Do not use means to accelerate the defrosting process or to clean, other than those recommended by the manufacturer.
- The appliance shall be stored in a room without continuously operating ignition sources (for example: open flames, an operating gas appliance or an operating electric heater).
- Do not pierce or burn.
- Be aware that refrigerants may not contain an odour. (DD.2)

### 1.3 Explanation of symbol displayed on the unit.



#### Caution, risk of fire

#### WARNING

- This symbol shows that this appliance uses a flammable refrigerant.
- If the flammable refrigerant is leaked and exposed to an external ignition source, there is a risk of fire.



#### CAUTION

This symbol shows that the operation manual should be read carefully.



#### CAUTION

This symbol shows that a service personnel should be handling this equipment with reference to the installation manual.



#### CAUTION

This symbol shows that information is available such as the operating manual or installation manual.

# ■ ■ ■ Features and Components

## Features

- Brand new appearance, compact structure, smooth line, simple and generous shape.
- Functions of refrigeration, dehumidification, air supply and continuous drainage.
- Outdoor interface is set high to facility assembly and keep the smooth flow of the heat pipe.
- LED displays the control panel, beautiful and fashionable, with high-quality remote control. It adopts a user-friendly remote control design.
- Air filtration capability.
- Timing switch function.
- Protection function of automatically restarting the compressor after three minutes, a variety of other protection functions.
- The Max operation temperature for the air conditioner Cooling: 95/76°F; Temperature operation range: 45-113°F.

# Component

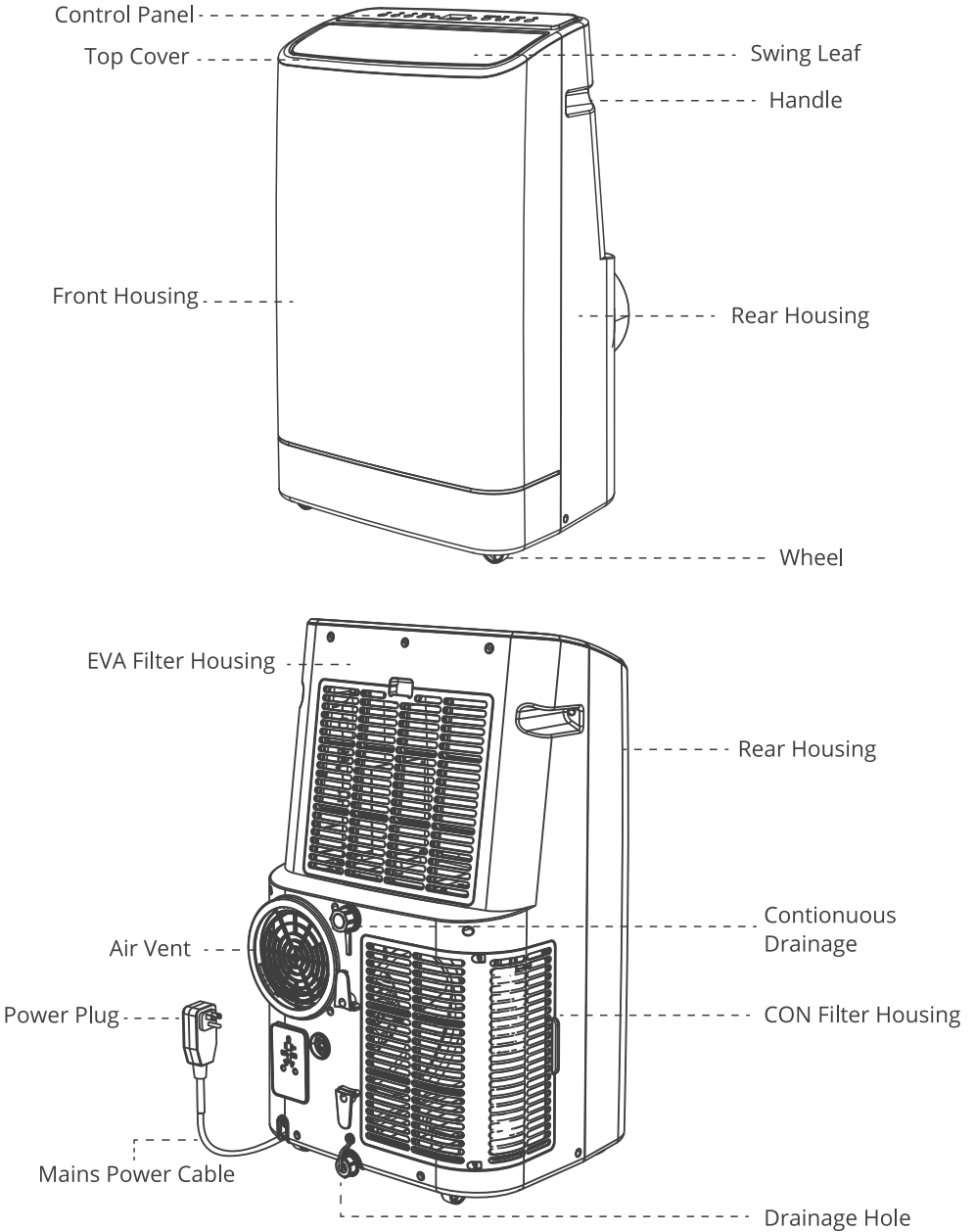

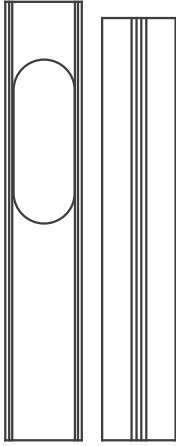

Ajustable Slide Bar



Exhaust Hose



Remote Control

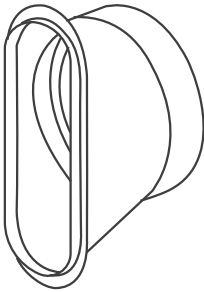

Slide Bar Connector

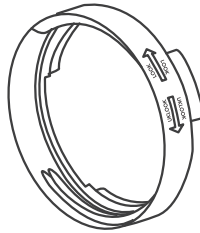

Exhaust Pipe Joint

# Control Setting

## Control Panel Operation Instructions

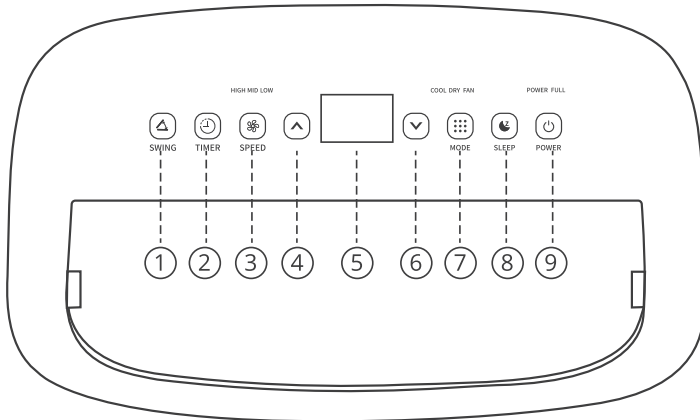

- ① Swing Control
- ② Timer Control
- ③ Fan Speed Control
- ④ Timer / Temperature Set Controls
- ⑤ Display Window
- ⑥ Timer / Temperature Set Controls
- ⑦ Mode Control
- ⑧ Sleep Mode
- ⑨ Power Control

### Power Control

Press  to turn ON / OFF the unit. The air vent will automatically swing open when the unit is turned ON and automatically close when the unit is turned OFF.

### Restart Delay

If the unit turns OFF while operating in COOL mode, there will be an approx. 3-minute delay to restart the air conditioner in COOL mode. This is a safety feature and added to help protect and extend the life of the compressor. After 3 minutes, you will be able to turn ON the unit as usual.

### Swing Control

Press  to activate automatic oscillation of louvers. Press Swing Control again to stop swing when louvers reached a desired angle.

## **Timer Control**

While the unit is turned on, press the timer button then press the **▲** or **▼** to select the number of hours you would like the unit to continue to run. The unit will turn on / off automatically. Timer Control is to be set in 1 hour intervals.

## **Auto Turn OFF**

While unit is running, press the **▲** or **▼** button to select the number of hours you want the unit to run in air conditioning mode.

## **Auto Turn ON**

When unit is in a standby mode (plugged in with power light on), then press the **▲** or **▼** button to select the number of hours until you want the unit to automatically start running.

## **Fan Speed Control**

3 settings: High, Medium, and Low.



**Note:** Fan Speed cannot be adjusted in Sleep Mode and Dehumidifying Mode.

## **Timer / Temperature Set Controls**

The **▲** and **▼** buttons can be used to adjust and set your desired temperature in Cooling modes. They can also be used to set the Timer (see "Timer Control" below).

**Note:** Temperature and Timer cannot be adjusted in Fan and Dehumidify modes.

## **Mode Control**

- **Settings:** Cool, Dehumidifying, Fan.  
The corresponding indicator light will illuminate to indicate the current mode setting.
- **Cooling Mode (COOL)**   
Adjust fan speed and air temperature to suit your desired comfort level. Temperature setting range is 61°F - 88°F.
- **Dehumidifying Mode (DRY)**   
Air is dehumidified as it passes through the unit, without being in full cooling mode. The fan speed is preset as LOW speed and can NOT be adjusted.

**Note:** If the unit will be used mainly as a dehumidifier, do not connect the exhaust hose. Continuous drainage is then necessary (refer to Continuous Draining for Dehumidifier Mode).

### **Important:**

The Dehumidifier Mode is used to support moisture reduction but should not be expected to dehumidify to the same degree as a standard dehumidifier only appliance. The built-in dehumidifier automatically adjusts dehumidification based on ambient room temperatures. It is not possible to adjust to a desired humidity percentage. The front display only shows the current and desired temperatures. It does not show humidity levels.

- **Fan Mode (FAN)** 

For air circulation without air conditioner cooling.

- **Sleep Mode** 

Sleep Mode is for energy-saving comfort during the night. When Sleep Mode  is ON in Air Conditioning Cooling Mode, the fan will automatically stay on LOW Speed and the set temperature will increase by 1.8°F on the first hour. It will increase another 1.8°F on the second hour, and remain at this temperature for the rest of the night, until Sleep Mode is deactivated.

**Note:** The control panel lights will turn OFF after 10 seconds and light up again when any button is pressed. Sleeping mode is invalid under dehumidifying and fan mode.

- **Water Full Light** 

Condensation may accumulate in the unit.

If the internal BOTTOM tray becomes full tank becomes full, the Water Full Light  will illuminate and unit will beep 5 times for 5 seconds. The unit will not operate until the unit has been drained (refer to Water Condensation Drainage).









## **Additional Features**

### **Automatic Defrost Feature**

Sometimes when the unit is operating in cooling mode in lower room temperatures (e.g. lower than 60°F), the internal cooling coils may become too cold and sometimes frost may develop on the cooling coils. When this happens, the unit will automatically pause operation and defrost the cooling coils to protect the unit. The air conditioner will restart automatically when the system has defrosted and returns to standard operational temperatures.

## Operation Instructions of Remote Control

The air conditioner can be controlled with the remote control. Two AAA-batteries are required to use the remote control.

-  **POWER:** Press the POWER button to turn the unit on and off.
-  **MODE:** Press the MODE button to switch between cooling, dry, fan modes.
-  **UP:** Press the UP button to increase the desired temperature and set the duration of the timer.
-  **DOWN:** Press the DOWN button to reduce the desired temperature and set the duration of the timer.
-  **FAN:** Press the FAN button to cycle between low, medium and high fan speeds.
-  **TIMER:** Press the TIMER button to set the duration of the power on or power off timer.
-  **SWING:** Press the swing button to change the orientation of the louvers to direct the air.
-  **TEMPERATURE UNIT:** Press to switch between displaying the temperature in Celsius and Fahrenheit.
-  **SLEEP MODE:** Press to turn on the sleep mode. The unit will work with energy saving logic and the lowest fan speed.

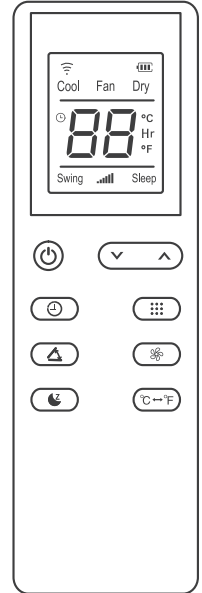

## Protection Function

### Frost Protection Function

In cooling mode, if the temperature of the exhaust pipe is too low, the unit will automatically enter protection status; if the temperature of the exhaust pipe rises to a certain temperature, it can automatically revert to normal operation.

### Overflow Protection Function

When water in the water pan exceeds the warning level, the alarm will automatically ring, and the "FULL" indicator light will flash. At this point, you need to move the drainage pipe connecting the unit or the water outlet to sewer or other drainage area to empty the water (details see Drainage Instructions at the end of this chapter). After the water is emptied, the unit will automatically return to the standby state.

## Automatic Defrosting (cooling model have this function)

The machine has automatic defrosting function. Defrosting can be achieved through four way valve reversing.

## Protection Function of the Compressor

To increase the service life of the compressor, it has a 3-minute delay booting protection function after the compressor is turned off.

# Installation and Adjustment

## Installation

Warning: Before using the unit, keep it upright for at least two hours.

The unit can be easily moved in the room. In the moving process, ensure that the unit is in the upright position and should be placed on a flat surface. Do not install and use the unit in the bathroom or other humid environments.

Install the heat pipe assembly (as shown in Fig.1)

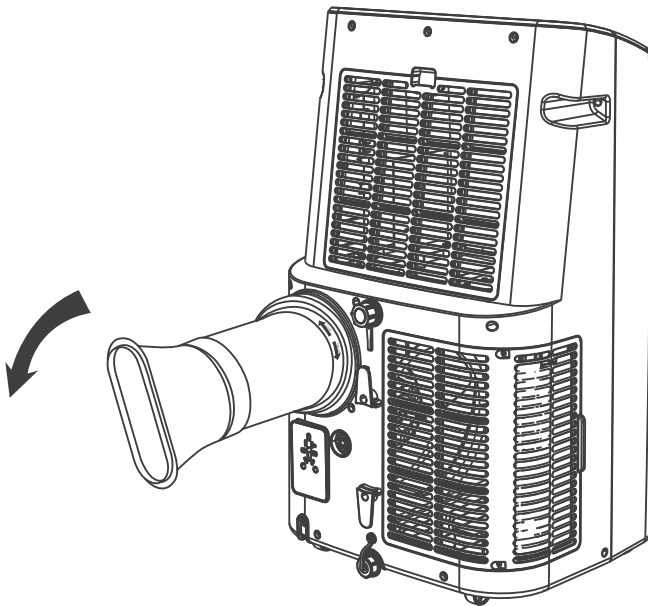

Figure 1

- Take out the outer connector assembly and the exhaust pipe assembly, and remove the plastic bags;
- Insert the heat pipe assembly (the end of the exhaust joint) into the back panel vent slot (push to the left) and complete the assembly (as shown in figure 1).

## Installation of Window Sealing Plate Components

- Half open the window, and mount the window sealing plate assembly to the window (as shown in Fig.2 and Fig.3). Components can be placed in horizontal and vertical direction.
- Pull various components of the window sealing plate assembly open, adjust their opening distance to bring both ends of the assembly into contact with the window frame, and fix various components of the Install the window sealing plate assembly.

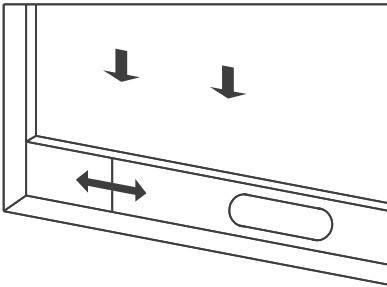

Figure 2

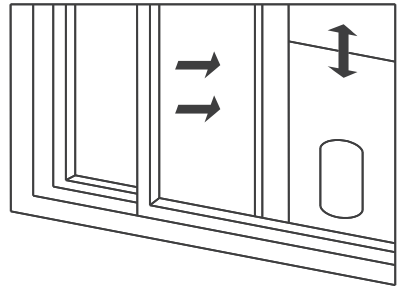

Figure 3

### Notes:

- The flat end of the exhaust pipe joints must be snapped into place.
- The pipe cannot be distorted nor has substantial turning (greater than 45°). Keep the ventilation of the exhaust pipe unblocked.

## Install the body

- Move the unit with installed heat pipe and fittings before the window, and the distance between the body and walls or other objects shall be least 50 cm (as shown in Fig.4).

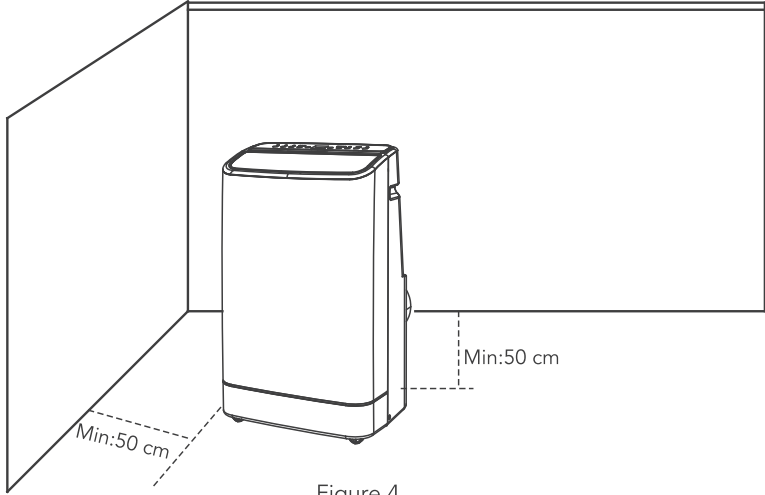

Figure 4

- Elongate the exhaust pipe and snap the flat end of the exhaust pipe joints into the hole of the window sealing plate assembly (as shown in Fig.5 and Fig.6)

**Notes:**

- 1) The flat end of the exhaust pipe joints must be snapped into place.
- 2) The pipe cannot be distorted nor has substantial turning (greater than 45°). Keep the ventilation of the exhaust pipe not blocked.

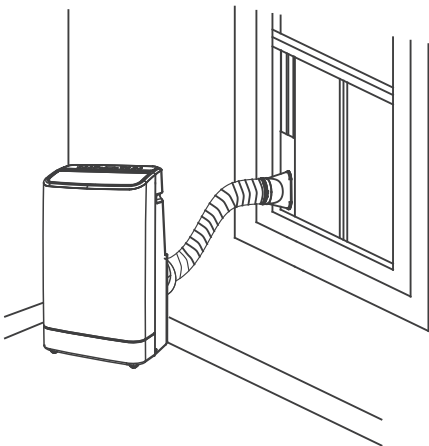

Figure 5

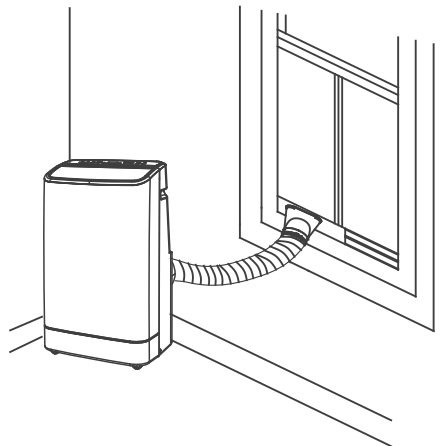

Figure 6

### Important Notice:

The length of the exhaust hose shall be 280~1,500mm, and this length is based on the specifications of the air conditioner. Do not use extension tubes or replace it with other different hoses, or this may cause a malfunction. Exhaust host must be not blocked; otherwise it may cause overheating.

## ■ Drainage Instructions

**This unit has two drainage methods: manual drainage and continuous drainage.**

### Manual Drainage

- When the unit stops after the water is full, turn off the unit power and unplug the power plug.  
Notes: Move the unit carefully, so as not to spill the water in the water pan at the bottom of the body.
- Place the water container below the side water outlet behind the body.
- Unplug the water plug, the water will automatically flow into the water container.

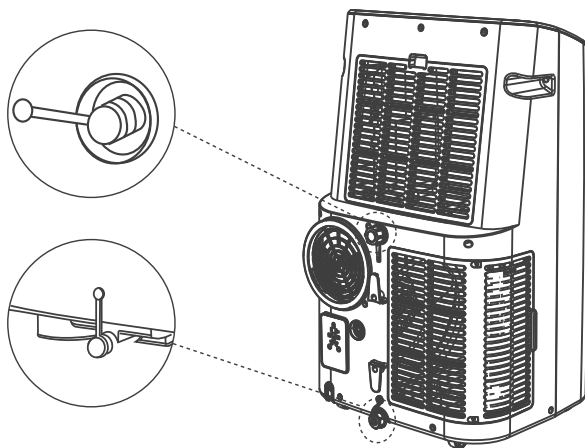

### Notes:

- Keep the drainage cover and the water plug properly.
- During drainage, the body can be tilted slightly backwards.
- If the water container cannot hold all the water, before the water container is full, insert the water outlet with the water plug as soon as possible to prevent water from flowing to the floor or the carpet.
- When the water is discharged, insert the water plug, and tighten the drainage cover.

**Continuous drainage (Optional) (only applicable to dehumidifying), as shown in figure:**

- Unplug the water plug.
- Set the drainage pipe into the water outlet.
- Connect the drainage pipe to the bucket.

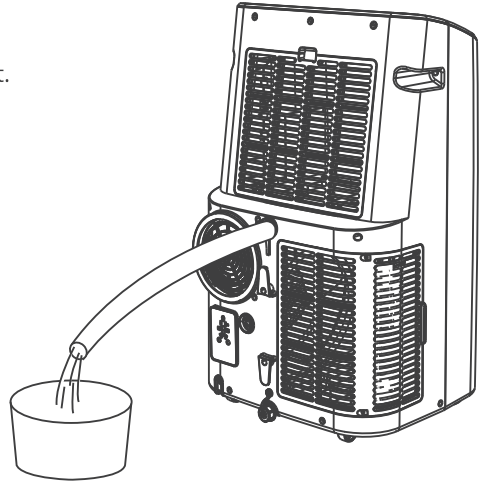

## ■ Maintenance

**Cleaning: Before cleaning and maintenance, turn off the unit and unplug the plug.**

### Clean the Surface

Clean with surface of unit with a wet soft cloth. Don't use chemicals, such as benzene, alcohol, gasoline, etc; otherwise, the surface of the unit will be damaged or even the whole unit will be damaged.

### Clean the Filter Screen

If the filter screen is clogged with dust, and the effectiveness of the unit is reduced, be sure to clean the filter screen once every two weeks.

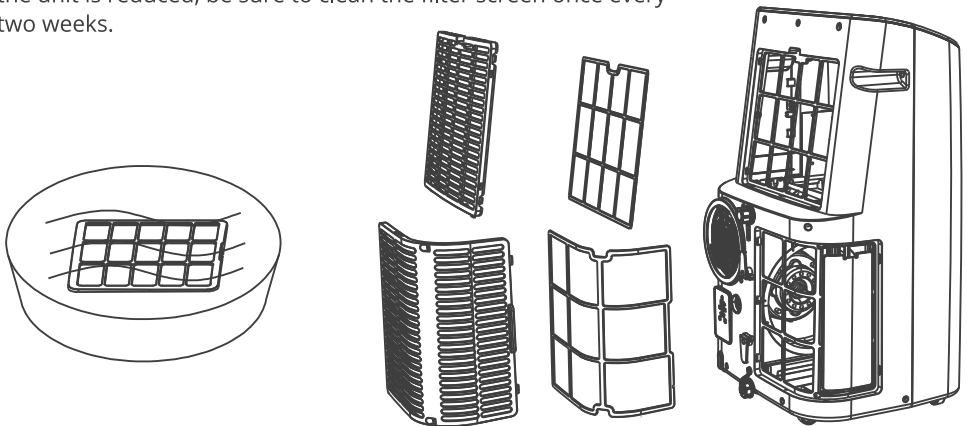

## Clean the Upper Filter Screen Frame

- Take out EVA filter net.
- Put the EVA filter screen into warm water with neutral detergent (about 104°F) and dry it in the shade after rinsing clean.

## ■ ■ Unit Storage

**If the appliance will not be used for a long time, follow these steps:**

- Be sure to drain the left-over water condensation. Remove BOTH upper and bottom drain plugs and use a drain pan to collect the water (make sure to replace the Drain plug Caps when finished).
- To dry excess moisture, run the unit in Fan only mode for 30 minutes before storing.
- Turn off and unplug the Portable Air Conditioner from the power supply.
- Remove the dust filter and clean with water. Dry the dust filter and then reinstall.
  - Remove the Hose from the unit by rotating anti-clockwise then pulling away.
  - Remove the Window Bracket, Window Bracket Panel Adapter and Hose Connector.
  - It is recommended to store the Window Kit parts in a bag together with the Remote Control, Drain Tube and placing them together with the Portable Air Conditioner unit.
  - If needed, you can clean the Window Kit with a damp cloth and water before storing.
- Make sure all parts of the Window Kit are dry before storage.
- Cover the Portable Air Conditioner with a cloth/ plastic bag before storage, to protect from dust and scratches collecting on the surface of the unit.
- It is recommended to coil the power cord before storing to ensure the cord is protected from bents and creases.
- Store the Portable Air Conditioner in a cool, dry place, away from direct sunlight.

# ■ ■ ■ Troubleshooting

Do not repair or disassemble the air conditioning by yourself. Unqualified repair will lead to failure of the warranty card, and may cause damage to users or their properties.

Problems	Reasons	Solutions
The air conditioning does not work.	There is no electricity.	Turn it on after connecting it to a socket with electricity.
	The "Full" indicator will flash.	Discharge the water inside.
	The ambient temperature is too low or too high.	Recommend to use the unit in a temperature of 44-95°F.
	In cooling mode, the room temperature is lower than the set temperature.	Change the set temperature.
	In dehumidification mode, the ambient temperature is low.	The unit is placed in a room with an ambient temperature of greater than 62°F.
The cooling effect is not good.	There is direct sunlight at the product.	Pull the Curtain.
	Doors or windows are open; there are a lot of people; or in cooling mode, there are other sources of heat.	Close doors and windows, move away from the heat source or add new air conditioner.
	The filter is dirty.	Clean or replace the filter screen.
	The air inlet or outlet is blocked.	Clear obstructions.
Big Noise	The air conditioning is not placed on a flat surface.	Put the unit on a flat and hard place (to reduce noise).
Compressor does not work.	Overheat protection starts.	Wait for 3 minutes until the temperature is lowered, and then restart the unit.

Problems	Reasons	Solutions
The remote control does not work.	The distance between the unit and the remote control is too far.	Let the remote control get close to the unit, and make sure that the remote control directly faces to the direction of the remote-control receiver.
	The remote control is not aligned with the direction of the remote-control receiver.	
	Batteries are dead.	Replace batteries.
Displays 'E2'.	The pipe temperature sensor is abnormal.	Please contact professional service technician or after-sales service provider.
Displays 'E1'	The room temperature sensor is abnormal.	Please contact professional service technician or after-sales service provider.

**Note:**

If problems not listed in the table occur or the above recommended solutions are not effective, please contact professional service technician or after-sales service provider.

## Appendix

### Fuse Parameters

Voltage: 250V      Current: 3.15A







Model: JHS-A020J-09KR-D  
Company: Garvee Innovation Inc.  
Address: 4215 E Airport Dr, Ontario, CA, USA  
Email: support@garvee.com  
Website: <http://www.garvee.com>  
Made in China

