









VEVOR

Upgrade · The Home Creator Way

HEAVY DUTY DRAWER SLIDES

MODEL:5301 / 5301Z

VEVOR Support Center

1	5301/530 1Z-16"		2	5301/5301Z- 18"	
3	5301/530 1Z-20"		4	5301/5301Z- 24"	
5	5301/530 1Z-30"		6	5301/5301Z- 36"	
7	5301/530 1Z-38"		8	5301/5301Z- 60"	

MODEL:5301 / 5301Z



This is the original instruction, please read all manual instructions carefully before operating. VEVOR reserves a clear interpretation of our user manual. The appearance of the product shall be subject to the product you received. Please forgive us that we won't inform you again if there are any technology or software updates on our product.



Warning-To reduce the risk of injury, user must read instructions manual carefully.

WARNING:

1.The product complies with relevant standards and regulations.
Installation of this device must comply with all applicable regulations, and it

should only be operated in well-ventilated areas. Please read the user manual before installing and using this equipment.

2. Please wear safety goggles and work gloves properly during assembly.
3. Do not try to assemble the product when feeling tired or when under the influence of alcohol, drugs, or medication.
4. Load-bearing capacity and other product parameters are applied to the properly and completely assembled product only.
5. Separate and count all parts and hardware.
6. Prepare the following tool: Philips Head Screwdriver.
7. If using power tools, please be careful to slow down and stop when needed.
8. Two people are required for assembly.
9. Follow the intended uses only.





Save the instructions.

Attention:





1. Pay attention to waterproof and moisture-proof, should not be placed in the open air, wet or chemical environment.
2. Pay attention to strong chemicals, do not use strong chemicals, cleaning agents or strong detergents to clean products. Clean the appearance of the product stains can be wiped with a clean cloth.
3. Pay attention to anti-high temperature, do not put the product in an environment where the temperature is too high (recommended product environmental requirements: working temperature :-10°C-50°C).

5301/5301Z-16"~5301/5301Z-30"

Part List					
Code	Picture	Qty.	Code	Picture	Qty.

1		1	2		1
3		16	4		16

5301/5301Z-32"~5301/5301Z-60"

Part List					
Code	Picture	Qty.	Code	Picture	Qty.
1		1	2		1
3		24	4		24

Product Introduction

Model	Applicable Drawer Length (inch)	Sliding Length (mm)	Max. Load (kg / lbs)
--------------	--	----------------------------	-----------------------------

5301/5301Z-16"	16.5	400	106/ 234
5301/5301Z-18"	18.5	450	113/ 250
5301/5301Z-20"	20.5	500	105/ 233
5301/5301Z-24"	24.5	600	98/ 216
5301/5301Z-30"	30.5	750	80/176.5
5301/5301Z-36"	36.5	900	61/134.6
5301/5301Z-38"	38.5	950	54/119
5301/5301Z-60"	60.5	1500	39/85

5301/5301Z Installation Hole Pattern(Units:mm)

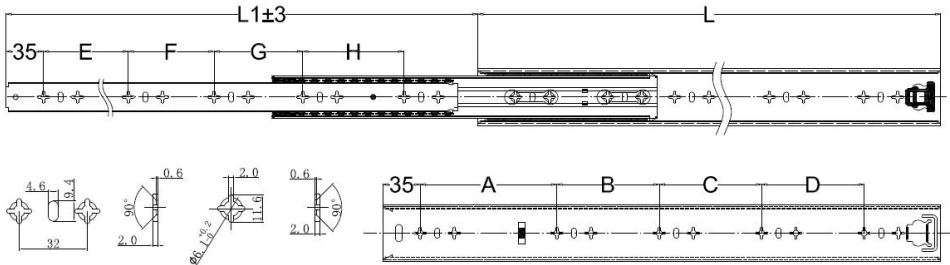

Ltem No	L	L1	A	B	C	D	E	F	G	H
16"	400	405	128	128			128	128		
18"	450	455	160	160			128	224		
20"	500	513	128	224			128	224		
24"	600	612	160	160	160		224	256		
30"	750	765	224	224	192		224	224	192	
36"	900	902	256	256	256		256	256	256	
38"	950	957	256	256	288		256	288	256	
60"	1500	1510	352	352	352	320	320	352	352	320

Installation Procedure (Method 1)

1.Pay attention to the installation space on both sides.(Units:mm)

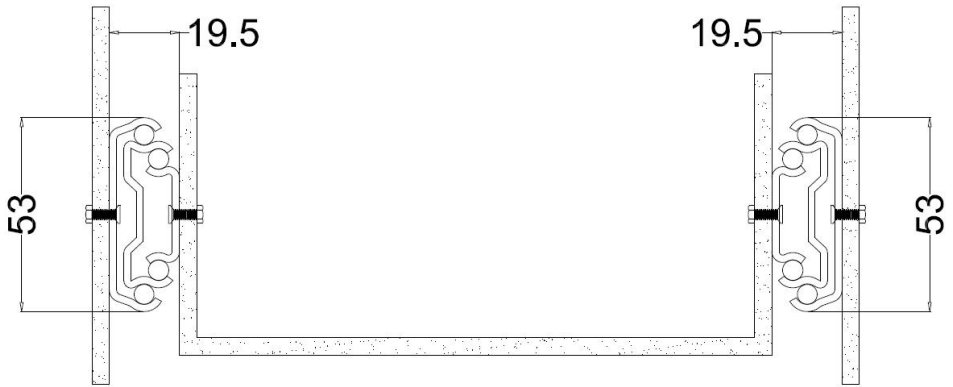

2. Install the outer rail.

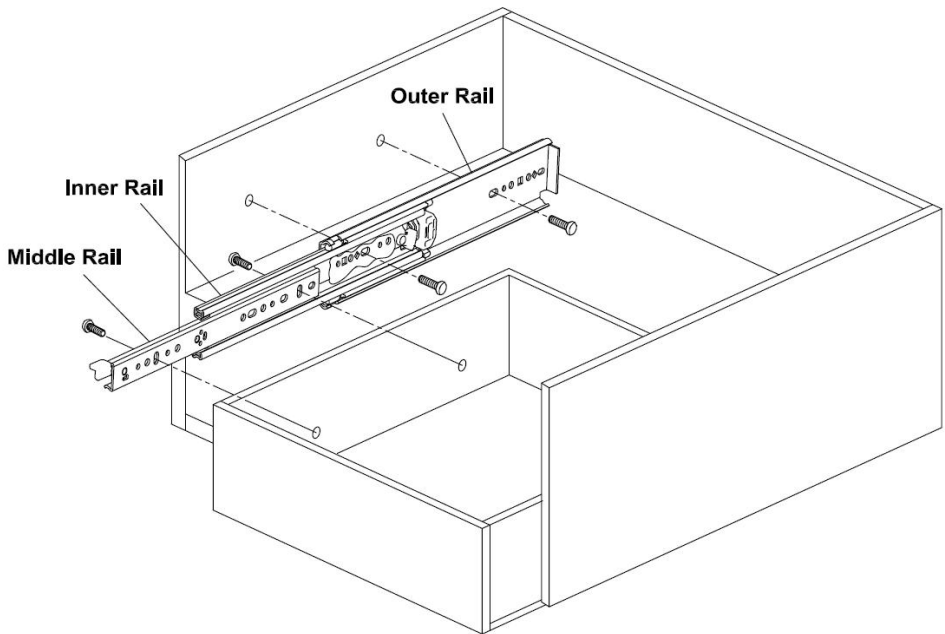

3. Install the drawer.

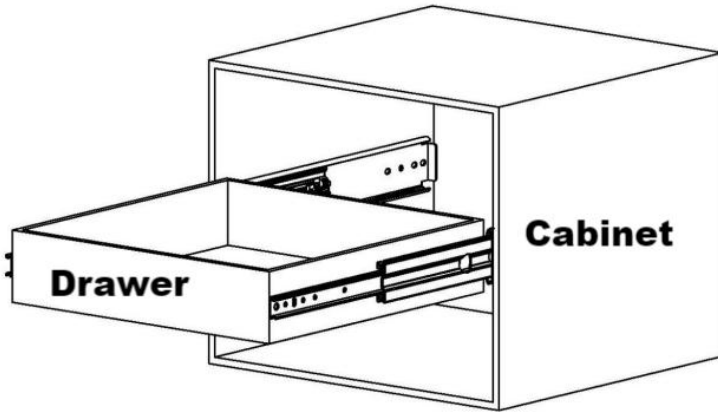

Press To Unlock



Installation Procedure(Method 2)

1. Pay attention to the installation space on both sides. (Units: mm)

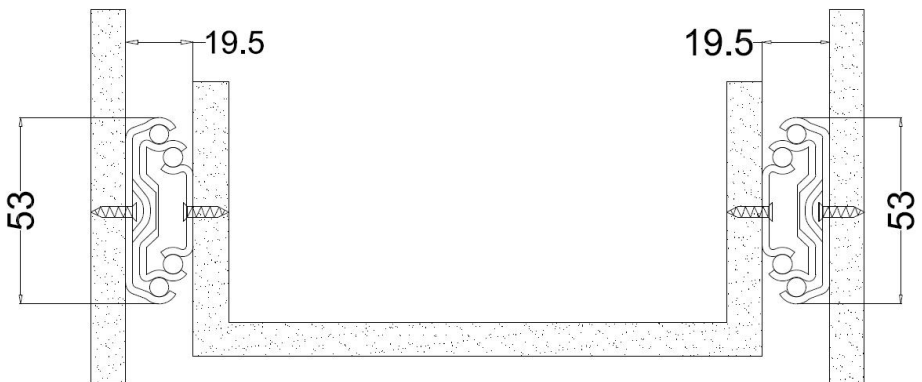

2. Install the outer rail.

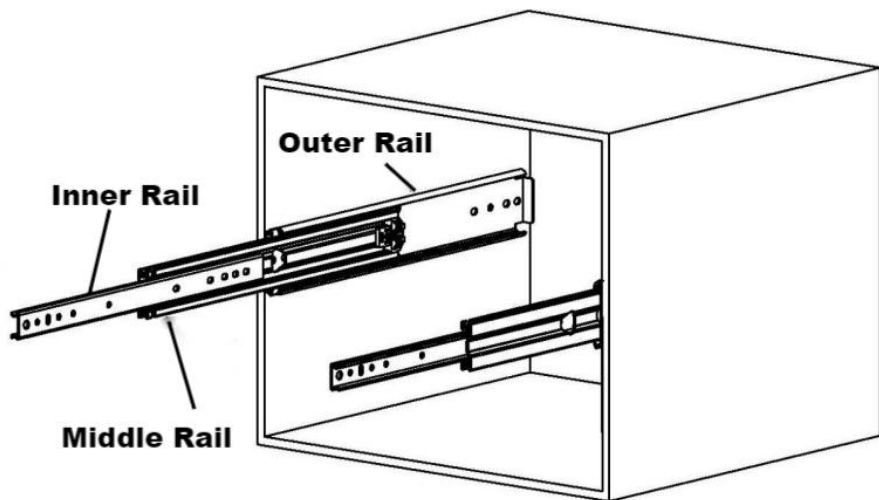

3. Install the drawer.

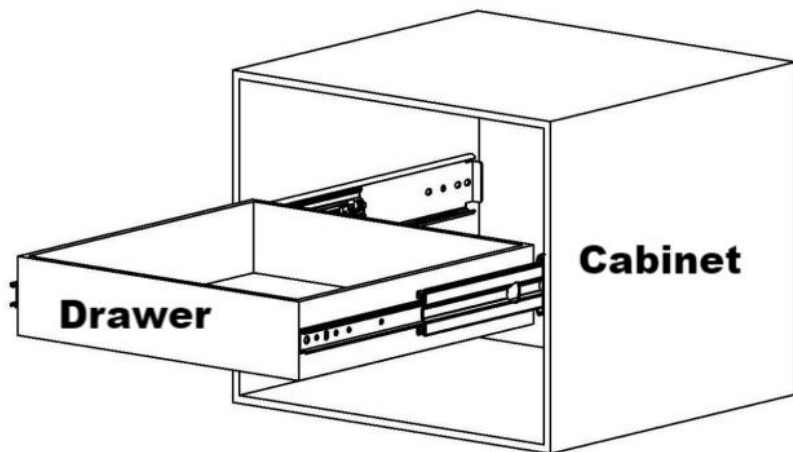

Press To Unlock



