



Farmington®
19-1/4" oval drop-in bathroom sink
K-2905-1

Features

- Single faucet hole
- Oval basin
- Overflow drain

Material

- KOHLER® enameled cast iron

Installation

- Drop-in

Recommended Products/Accessories

- K-8998 P-Trap
- K-23726 Drain treatment
- K-23725 Cast iron cleaner



ADA **CSA B651** **OBC**

Codes/Standards



ASME A112.19.1/CSA B45.2
ADA
ICC/ANSI A117.1
CSA B651
OBC

**KOHLER® Enameled Cast Iron
Kitchen and Bathroom Sink Lifetime
Limited Warranty**

See website for detailed warranty information.

Available Colors/Finishes

Color tiles intended for reference only.

Color	Code	Description
	0	White
	96	Biscuit
	7	Black Black™

1-800-4KOHLER (1-800-456-4537)

Kohler Co. reserves the right to make revisions without notice to product specifications.

For the most current Specification Sheet, go to www.kohler.com USA or www.kohler.ca Canada

6-10-2025 20:33 - US/CA

THE BOLD LOOK
OF **KOHLER®**

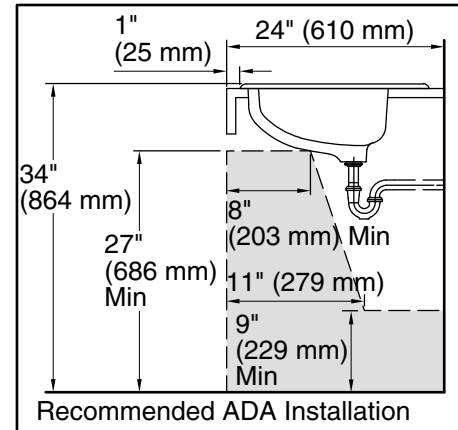
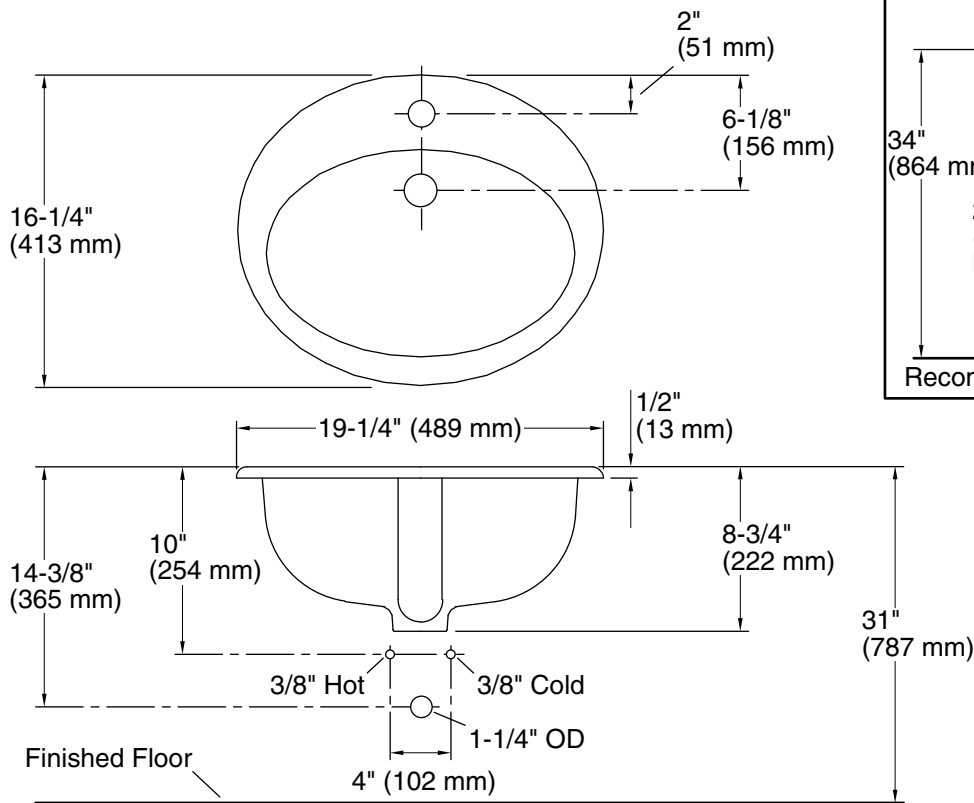

Technical Information

All product dimensions are nominal.

Basin configuration:	Single Bowl
Bowl area:	Length: 16" (406 mm) Width: 11" (279 mm) Water depth: 5" (127 mm)
With overflow:	Yes
Number of deck holes:	1
Faucet hole(s):	1-3/8" (35 mm)
Drain hole:	1-11/16" (43 mm)
Template:	1002973-7, required, included

Notes

Install this product according to the installation instructions.

NOTICE: Countertop manufacturer or cutter must use the current product template available at www.kohler.com, or by calling 1-800-4KOHLER. Kohler Co. is not responsible for cutout errors when the incorrect cutout template is used.

ADA, OBC, CSA B651 compliant when installed to the specific requirements of these regulations.