

# Bella Premier Railing & Stair Kit Installation Instructions

English Instructions.....1

**FREEDOM**<sup>®</sup>  
OUTDOOR LIVING



Read all instructions prior to installing product.  
Refer to manufacturers safety instructions when operating any tools.

To register your product, please visit: [freedomproduct.com](https://freedomproduct.com)

**⚠ WARNING:**

- Improper installation of this product can result in personal injury. Always wear safety goggles when cutting, drilling and assembling the product.
- Incorrect installation may cause harm to the product or individual.

**NOTICE:**

- DO NOT attempt to assemble the kit if parts are missing or damaged.
- DO NOT return the product to the store. For assistance or replacement parts call: 1-800-336-2383.

**BEFORE YOU BEGIN:**

Vinyl rail posts require an internal support system for weight-bearing purposes and therefore a post install kit or wood post is required inside a post jacket. Post install kit and wood post need to be purchased separately.

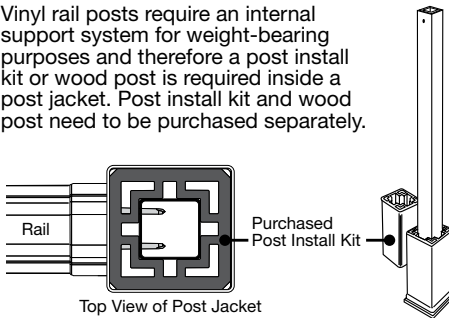

**TOOLS NEEDED:**

Tape Measure
Level
Hacksaw or Chopsaw
Rubber Mallet
Drill
#2 Square Drive Bit
1/8" Drill Bit
Pencil
Temporary Deck Board
Safety Glasses

**Railing & Stair Railing Components:**

Description
Top Rail
Bottom Rail
Balusters/Spindles
Two-Piece Support Brace(s)
Level Brackets
Stair Brackets
Left-Right Angle Brackets*
1 1/2" Square Drive Screws
2" Square Drive Screws
1" Square Drive Screws
Templates
Adhesive Foam Strips

\*Sold separately.



Level Brackets



Stair Brackets



Angle Brackets

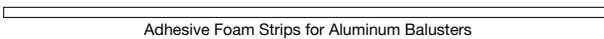

Adhesive Foam Strips for Aluminum Balusters

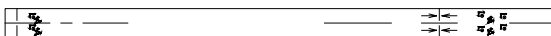

Bracket Template



Screws



Stair Bracket Templates

**Railing Kit**

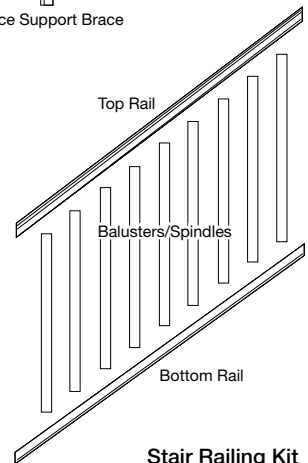
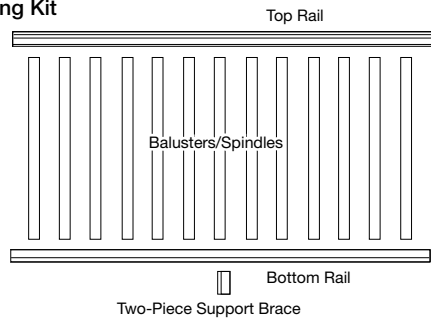

**Stair Railing Kit**

## FOR 10' RAILING ONLY:

Install enclosed screw through the bottom bracket as shown approximately  $\frac{1}{2}$ " from the front face of the bracket, centered vertically on the flat surface. Do this for each bottom bracket.

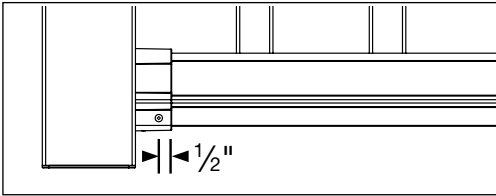

## LEVEL RAIL INSTALLATION:

1

Closely follow Post Install Kit installation instructions or use a Post Jacket on an existing wood post.

### NOTE:

Railing system is designed for use with both 4"x4" and 5"x5" vinyl post jackets. If using with a 4"x4" post jacket, rails come out of the box designed to fit structural posts 72" on center. If using a 5"x5" post jacket, the structural posts remain 72" on center, but the rail will have to be cut down slightly to fit.

2

### Bracket Dovetail Installation:

If installing rail system on a 4"x4" post jacket using a one-piece base trim, install the base trim over the post sleeve prior to installation. If installing rail system with 5"x5" post jacket using a two-piece base trim, installation template will be used to set railing height prior to installing the base trim.

Follow the instructions on template provided depending on installation type.

### 4"x4" Post jacket with Heritage trim:

- For 36" high rails, cut as needed and place dovetail install template against post sleeve directly on top of the base trim and secure in place with a rubber band (Fig. 1).
- For 42" high rails, the top bracket dovetail will install  $37\frac{1}{8}$ " from the top of the base trim and the bottom bracket will install  $\frac{3}{4}$ " from top of base trim (Fig. 2).

### 5"x5" Post jacket with two-piece trim

- For 36" high rails, place dovetail install template against post sleeve directly on top of the mounting surface and secure in place with a rubber band.
- For 42" high rails, the top bracket dovetail will install  $39\frac{1}{8}$ " from the top of the mounting surface and the bottom bracket will install 2" from the mounting surface.

3

With a  $\frac{1}{8}$ " drill bit, pre-drill the holes for the top and bottom brackets (Fig. 3). Remove template (if used).

4

Use 2" screws to attach top bracket dovetails. Screws must penetrate the steel insert (if using steel post install kit). Use  $\frac{1}{4}$ " screws to attach bottom bracket dovetails (Fig. 4).

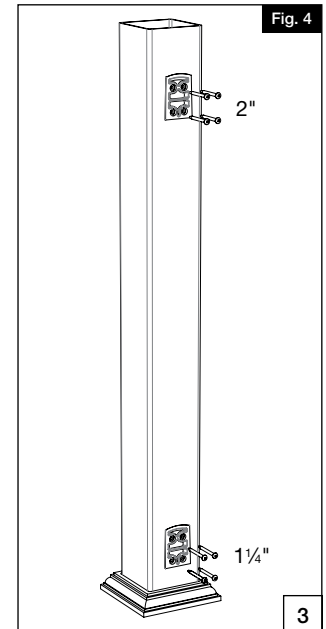
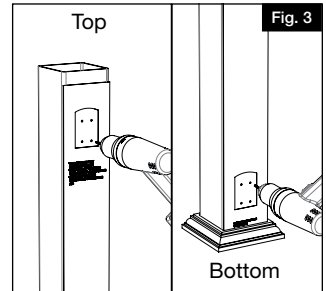
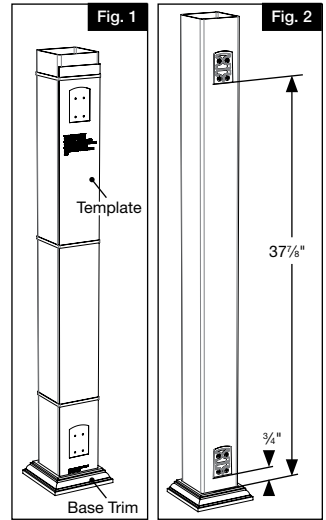

**5****Cut Rails to Length:**

Place bottom rail across post opening leaving equivalent spacing from the last baluster and post on each end (Fig. 5). Mark  $\frac{1}{2}$ " from end of post to allow room for bracket width and expansion (Fig. 6). Align top rail with bottom rail and cut both rails with miter box or hacksaw (See blade manufacturer's specs for correct blade) (Fig. 7).

**NOTE:**

- You will have to cut through an aluminum insert in the top rail of an 8' section.
- Prior to installing round aluminum balusters, insert the provided foam strip into the top of the top rail and bottom of the bottom rail (sides opposite of routed holes).
- Cut foam strip to rail length.
- **DO NOT REMOVE THE RELEASE PAPER FROM ENTIRE STRIP!** ONLY remove 1" of the release paper from each end of the foam strip to expose adhesive (Fig. 8).
- Press the foam strips onto rails (Fig. 9). For top rails 8' and longer in length, the strip will adhere to the aluminum stiffener instead of the top rail itself.

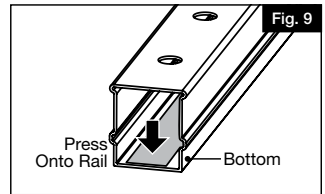
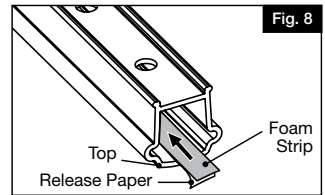
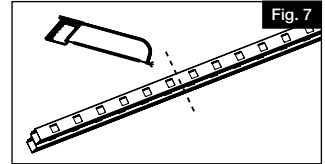
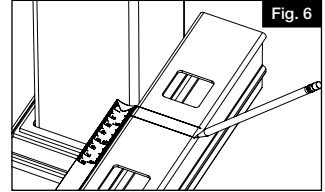
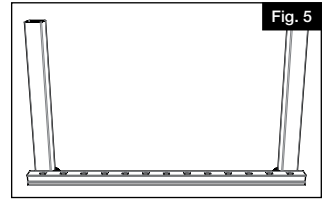
**6****Install 2" support brace to rail:**

2" support braces are included with railing kits.

Two support braces are included with 8' and 10' railing kits. Install support braces evenly across span of railing section.

Locate and mark the center point on the underside of the bottom rail. Attach the rail support to the bottom rail using the supplied set screw (Fig. 10).

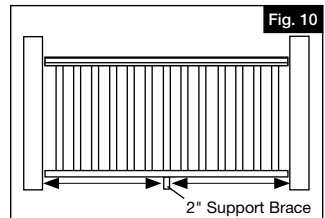
**4**

7

**Assemble Railing Section:**

Lay bottom rail on a clean smooth surface and snap balusters into routed holes (Fig. 11). Then repeat the process to connect the top rail (Fig. 12).

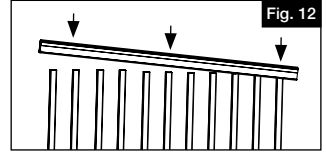
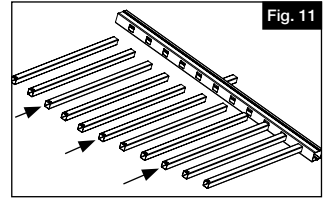

8

Slide brackets onto ends of rails (top and bottom) (Fig. 13).

**NOTE:**

DO NOT screw bracket into top rail until you reach Step 10.

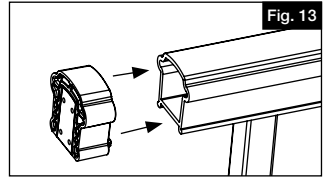

9

**Hang Assembled Rail Section onto Dovetails:**

Slide assembled rail section straight down between both posts, and onto each dovetail (Fig. 14).

**NOTE:**

For railing sections using aluminum balusters the installer will have to carefully hold top and bottom railings together to make sure section does not separate. (Aluminum balusters do not come with lock tabs)

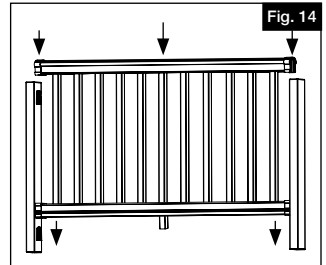

10

Install four 2" screws through the bottom of the top rail brackets into handrail.

- a. Pre-drill all four holes with a  $\frac{5}{32}$ " drill bit. Install the first two screws straight (90 degrees) through the pre-drilled holes in the bottom of the bracket.
- b. Install the next two screws at 45 degrees through the brackets into the post, starting with the dimples on the bottom of the top rail bracket (Fig. 15).

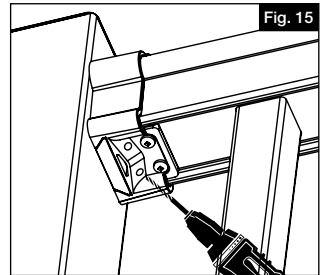

11

**Install 2" support brace to deck surface:**

Attach the rail support brace to the deck surface using support foot screw and snap the cover into place (Fig. 16).

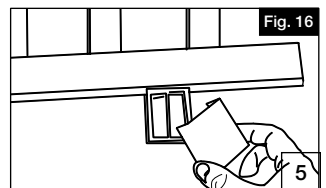

## ANGLED RAIL INSTALLATION:

1

For angled rail installation other than at 90 degrees or 180 degrees, purchase angle brackets.

Closely follow Post Install Kit installation instructions or use a Post Jacket on an existing wood post.

2

If installing rail system on a 4"x4" post jacket using a one-piece base trim, install the base trim over the post sleeve prior to installation. If installing rail system with 5"x5" post jacket using a two-piece base trim. Trim can be installed before or after rail installation.

- For the post where the angled bracket will be installed, measure from the top of the base trim to the bottom of the already installed top rail (Fig. 1).
- Mark this location on the side of the post where the angled bracket will be installed. Bases should align with installed rail section.
- While holding bracket base against post, mark with a pencil the four screw holes for the angled bracket placement on this post (Fig. 2).

### NOTE:

The measurement from the top of the base trim (or mounting surface) to the bottom of the top rail is the location of the bottom of the top rail brackets for all following rails.

3

With a 1/8" drill bit, pre-drill the holes for the top and bottom rail brackets.

4

Install angled bracket bases to post with 2" screws.

5

### Cut Rails to Length:

Place bottom rail across post opening leaving equivalent spacing from the last baluster and post on each end (Fig. 3). Mark 2" from end of post to allow room for bracket width and expansion (Fig. 4). Align top rail with bottom rail and cut both rails with miter box or hacksaw (See blade manufacturer's specs for correct blade) (Fig. 5).

### NOTE:

- You will have to cut through an aluminum insert in the top rail of an 8' section.
- Prior to installing round aluminum balusters, insert the provided foam strips into the top of the top rail and bottom of the bottom rails (sides opposite of routed holes). Cut to rail length. Then, remove 1" of the release paper from each end to expose adhesive (Fig. 6). Press fit the foam strips to rails (Fig. 7). DO NOT remove the release paper from entire strip – Only remove 1" from each end. For top rails 8' and longer in length, the strip will adhere to the aluminum stiffener instead of the top rail itself.

6

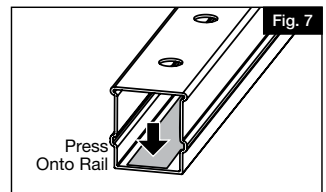
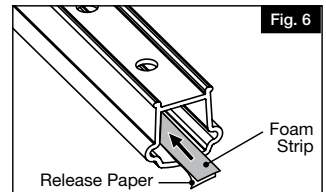
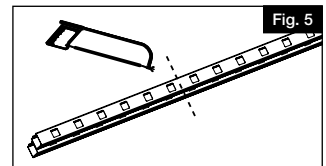
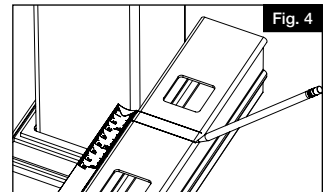
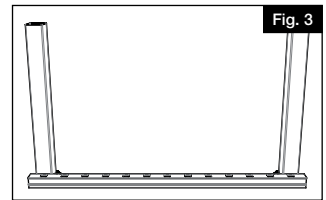
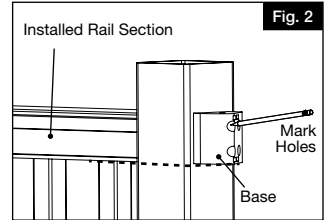
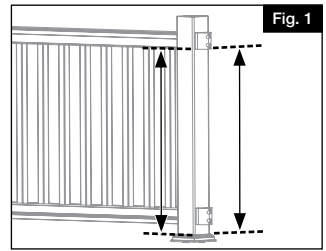

**6****Install 2" support brace to rail:**

2" support braces are included with railing kits.

Two support braces are included with 8' and 10' railing kits. Install support braces evenly across span of railing section.

Locate and mark the center point on the underside of the bottom rail. Attach the rail support to the bottom rail using the supplied set screw (Fig. 8).

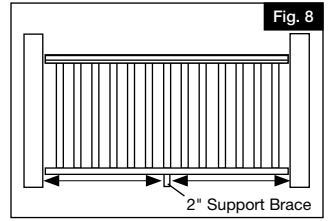
**7****Assemble Railing Section:**

Lay bottom rail on a clean smooth surface and snap balusters into routed holes (Fig. 9). Then repeat the process to connect the top rail (Fig. 10).

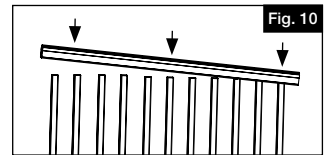
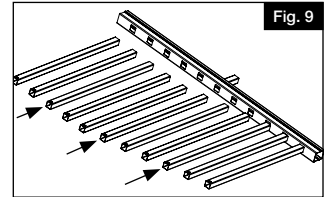
**8**

Slide brackets onto ends of rails (top and bottom) (Fig. 11).

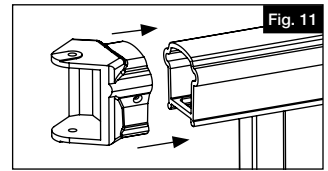
**9****Place Assembled Rail Section over Angled Bracket Bases:**

Slide assembled rail section straight between both posts, and over each angled bracket base (Fig. 12).

Slide provided pins in top/bottom angled brackets to lock angled brackets to base.

**NOTE:**

When installing angled rail and connecting the rail section, the angled bracket base needs to be flipped on the opposite post based on direction of the install.

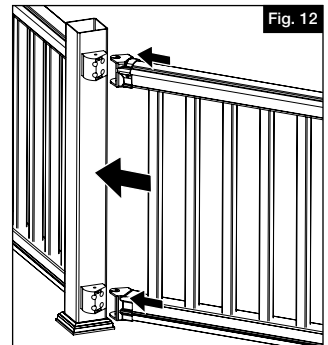
**10**

Install two 1/4" screws into the sides of each top angled bracket, securing it to the handrail. Insert screw caps onto each top bracket.

**11****Install 2" support brace to deck surface:**

Attach the rail support brace to the deck surface using support foot screw and snap the cover into place (Fig. 13).

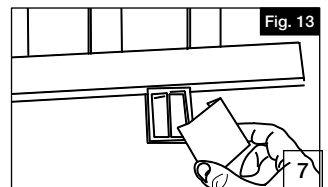

## STAIR RAIL INSTALLATION:

This guide outlines installation methods for installing stair railing in a variety of angles.

It is very important to identify the angle of your stairs, as the installation methods vary depending on what angle the stair is.

Within the following steps, be sure to pay close attention to the placement and utilization of the "stair angle template" to ensure you mark and cut your rails correctly, and note orientation of all brackets and railing in the supporting images.

- 1** Closely follow Post Install Kit installation instructions or use a Post Jacket on an existing wood post.

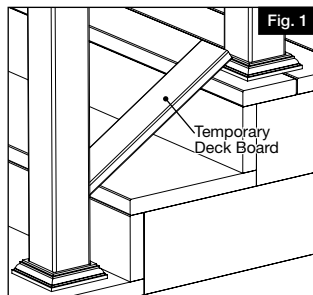

- 2** Temporarily secure a deck board (5/4") to your stair treads to determine the spacing between the nose of the stairs and your bottom rail (Fig. 1).

- 3** Place bottom rail on board and center the routes between posts making sure to leave equal distance from baluster route to post on both top and bottom. Mark the bottom rail using inside edge of posts (Fig. 2).

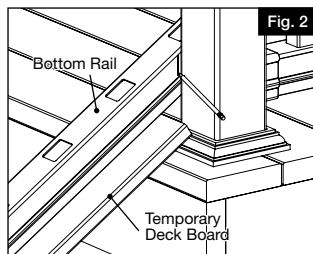

- 4** Measure angle – take rail to chop saw and measure angle (Fig. 3). Set saw and record angle.

**NOTE:**

Do not cut here. This is for acquiring measurements.

- If angle is  $31^{\circ}$ - $33^{\circ}$ , then go to Step 5
- If angle is  $<31^{\circ}$ , then skip Step 5 and proceed to Step 6
- If angle is  $>33^{\circ}$ , then skip Step 5 and 6, and proceed to Step 7

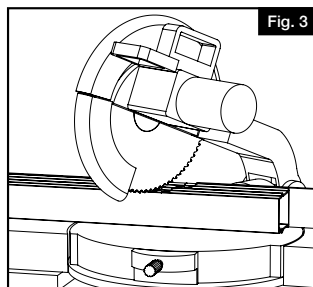



5

**For angles 31°-33°:**

- a. From the original line created by the post, mark another line  $\frac{1}{16}$ " on the inside of the bottom rail (closer to the baluster routes) (Fig. 4). This is accomplished by using the angle template (Fig. 5). This additional removal of material will allow for bracket clearance when the rail is installed. For this 31°-33° angle, the new line will be parallel to the previously drawn line.
- b. Chop saw should already be set at 32°
- c. Cut the bottom rail on the new mark at a 32°.

**NOTE:**

If your cut will result in a baluster route hole being cut through, repeat Step 3 and add/subtract a baluster route hole, re-center, mark and proceed to Step 4.

- d. Go to Step 8.

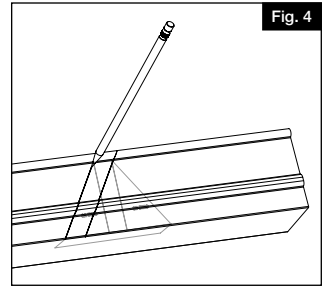

Fig. 4

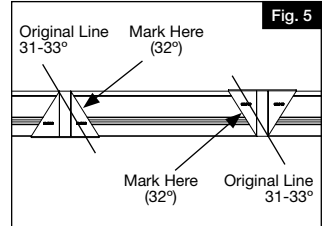

Fig. 5

6

**For angles 26°-31°:**

- a. From the original line created by the post, mark another line  $\frac{1}{16}$ " on the inside of the bottom rail (closer to the baluster routes) (Fig. 6). This is accomplished by using the angle template (Fig. 7). This additional removal of material will allow for bracket clearance when the rail is installed. For this 26°-31° angle, the new line will NOT be parallel to the previously drawn line.
- b. Set chop saw at 32°
- c. Cut the bottom rail on the new mark at a 32°.

**NOTE:**

If your cut will result in a baluster route hole being cut through, repeat Step 3 and add/subtract a baluster route hole, re-center, mark and proceed to Step 4.

- d. The rail will not match the angle of the stair, but instead match the inside of the bracket. The outside of the brackets will be cut to the proper angle in Step 11.
- e. Go to Step 8.

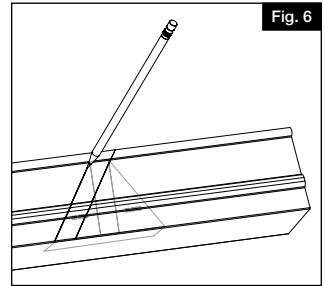

Fig. 6

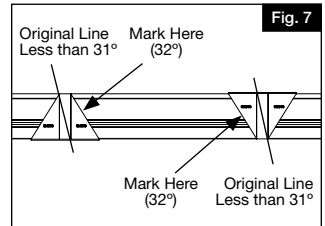

Fig. 7

**7****For angles 34°-38°:**

- From the original line created by the post, mark another line  $\frac{1}{16}$ " on the inside of the bottom rail (closer to the baluster routes) (Fig. 8). This is accomplished by using the angle template (Fig. 9). This additional removal of material will allow for bracket clearance when the rail is installed. For this 34°-38° angle, the new line will NOT be parallel to the previously drawn line.
- Set chop saw at 32°
- Cut the bottom rail on the new mark at a 32°.

**NOTE:**

If your cut will result in a baluster route hole being cut through, repeat Step 3 and add/subtract a baluster route hole, re-center, mark and proceed to Step 4.

- The rail will not match the angle of the stair, but instead match the inside of the bracket. The outside of the brackets will be cut to the proper angle in Step 11.
- Go to Step 8.

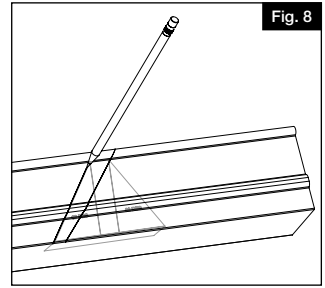
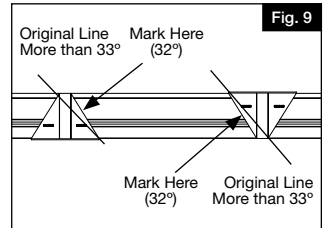
**Fig. 8****Fig. 9****8**

Place top rail flat on table. Lay the cut bottom rail on top of the top rail, with the routed holes facing in the same direction (Fig. 10). Line up the routes (Fig. 11).

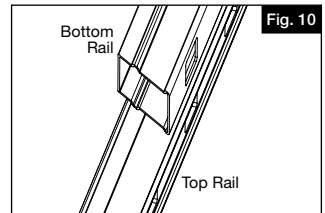
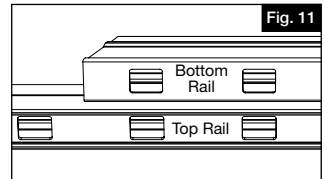
**Fig. 10****Fig. 11****9**

- Mark the top rail (using the bottom rail and a steel rule as a guide) to the top edge of the rail (Fig. 12).
- Make sure to extend the line out at the angle to the edge of the rail (mark line on "bump" of bottom of top rail on angle, not straight down).
- Cut the top rail to the lines using the chop saw set to 32°.

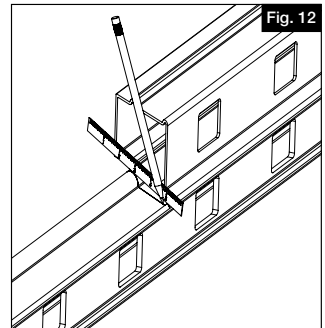
**Fig. 12****10**

**NOTE:**

Make sure bottom of rails are flush against saw fence (Fig. 13).

For angles 31°-33° go to Step 12.

For angles 26°-31° and 33°-38° go to Step 10.

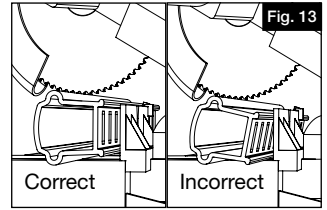

**10**

Place brackets on bottom rail, securing with 2 screws per bracket (#10 x 1") (Fig. 14). Then, place brackets on top rail, securing with one screw per bracket (#10 x 1") (Fig. 15).

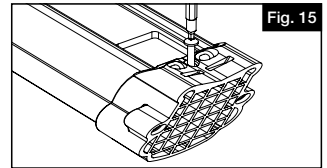
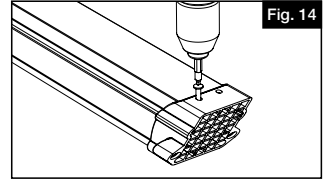

**11**

Set chop saw to stair angle and carefully cut all four brackets as shown. Be particularly careful to cut from the proper side of the bracket, depending on your angle. Cut smallest amount of bracket possible to get the correct angle on bracket (feather to edge).

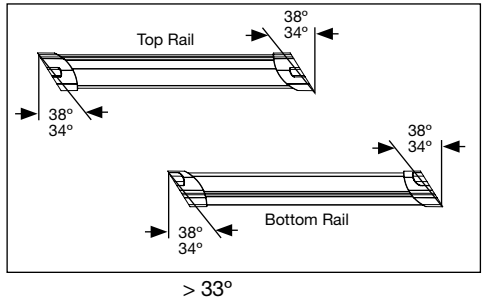
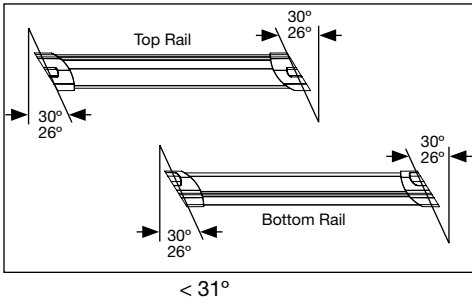

The cuts outlined above give you the results below. The angle cut on the rail matches the inside of the bracket (32°). The bracket outside cut matches the installation angle.

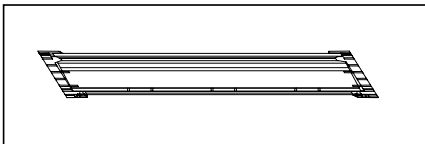

< 31°

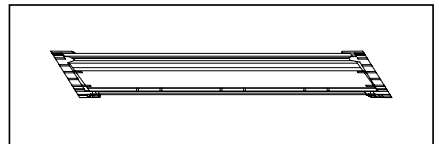

> 33°

Once the brackets have been cut to the proper angle, remove the screws from underneath the rails holding the brackets to the rails (from Step 10). This allows the rails to "float" in the brackets during assembly.

12

**Assemble your stair railing section:**

- a. Lock tabs on baluster/spindle must face outer edge of routed holes in rails (Fig. 16).
- b. Assemble your stair section by snapping balusters/spindles in rails.
- c. Place brackets on ends.
- d. Place assembled stair rail between posts on spacer board (Fig. 17).

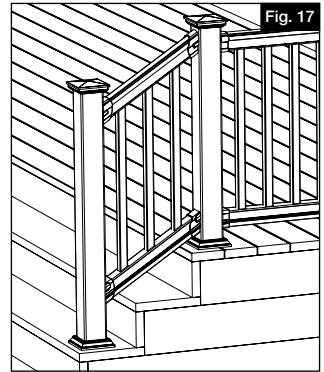
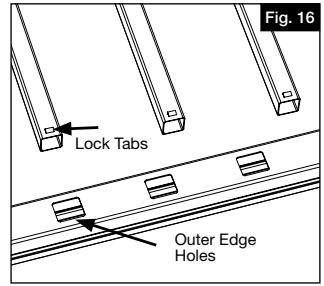

13

Make sure rail brackets are centered on posts. Drive two (#10 x 2") mounting screws into brackets and into posts, starting with the bottom rail (Fig. 18). Repeat for each bracket. Screw holes are angled inwards to provide clearance for the drill chuck. Removal of the bottom stair tread is not required.

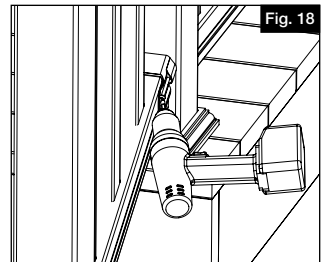

14

Two screws (#10 x 1") per bracket are driven under the top rail (Fig. 19). Holes are angled to allow an extension bit to clear balusters.

**NOTE:**

Screws are not required in the bottom of the bottom rail.

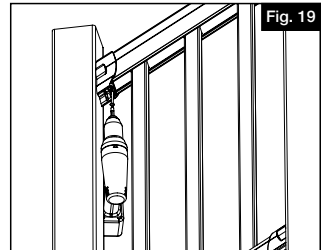

12



**FREEDOM**<sup>®</sup>  
OUTDOOR LIVING

Barrette Outdoor Living  
7830 Freeway Circle, Middleburg Heights, OH 44130  
freedomproduct.com • (888) 418-4400

BY **Barrette**  
OUTDOOR LIVING 