



Underscore® Rectangle

6' BubbleMassage™ Bath

K-1835-GCR



Features

- Center drain.
- Slotted overflow for deep soaking.
- Chromatherapy lighting allows you to select a preferred color scheme to suit your mood.
- Integral lumbar support.
- 72" (1829 mm) x 36" (914 mm) x 23" (584 mm)

Material

- Acrylic

Hydrotherapy

- 122 BubbleMassage™ airjets. 18 levels of massage intensity.
- Zones of Control feature allows you to target massage to back, midsection, or feet.
- Automatic purge cycles remove residual water from air channels after use.
- Built-in 300 W heater.
- Lighted keypad control.

Installation

- Drop-in or under-mount.

Required Accessories

K-7271 Brass Slotted Overflow Bath Drain

or

K-7272 PVC Slotted Overflow Bath Drain

Recommended Accessories

K-1491 Bath/Whirlpool Pillow

K-1601 Bath/Whirlpool Footstop

K-1705 Whirlpool/BubbleMassage™ Remote Control

K-593 Under-Mount Installation Kit

K-9497 2-1/2" Keypad Trim

K-24916 Wireless Music Kit

K-9498 3" Keypad Trim

K-1177 Vinyl Tiling-in Bead



Codes/Standards

ASME A112.19.7/CSA B45.10

CSA B45.5/IAPMO Z124

ASTM E162

ASTM E662

UL 1795

Greenguard UL 2818 - Gold

KOHLER® Plastic Baths and Receptors

Lifetime Limited Warranty

KOHLER® Hydrotherapy Components









Five-Year Limited Warranty

See website for detailed warranty information.

Available Color/Finishes

Color tiles intended for reference only.

Color Code Description

	0	White
	96	Biscuit
	47	Almond
	NY	Dune
	95	Ice™ Grey
	G9	Sandbar
	K4	Cashmere
	58	Thunder™ Grey
	7	Black Black™

1-800-4KOHLER (1-800-456-4537)

Kohler Co. reserves the right to make revisions without notice to product specifications.

For the most current Specification Sheet, go to www.kohler.com.

9-28-2018 09:59

THE BOLD LOOK
OF **KOHLER**®

No change in measurement if connected with drain illustrated. (K-7272)

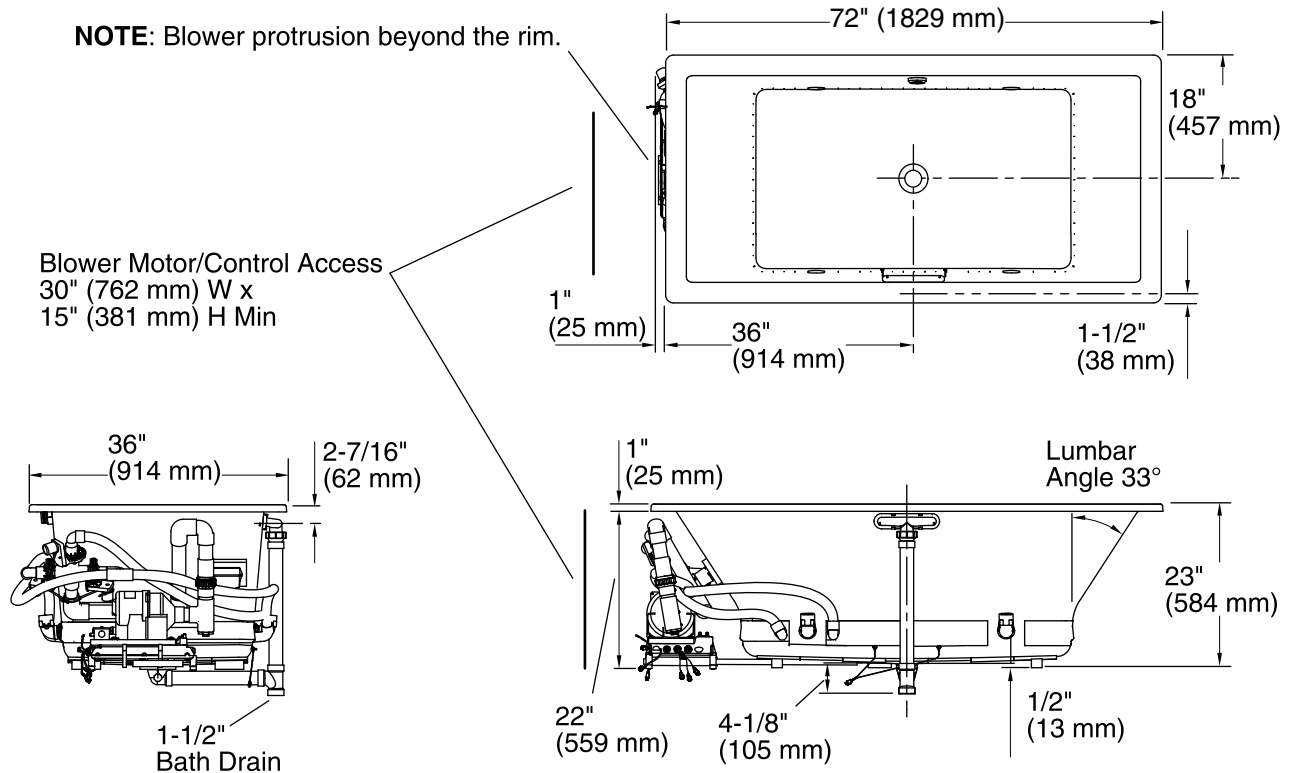

Required Electrical Service

One dedicated circuit required, protected with Class A Ground-Fault Circuit-Interrupter (GFCI) or Residual Current Device (RCD).

Blower: 240 V, 15 A, 50/60 Hz

Technical Information

All product dimensions are nominal.

Installation: Drop-in, Under-mount
 Drain location: Center
 Basin area, bottom: 45-3/4" x 25-15/16" (1162 mm x 659 mm)
 Basin area, top: 65-3/8" x 29-5/16" (1661 mm x 745 mm)
 Weight: 107 lbs (48.5 kg)
 Minimum floor load: 60 lbs/ft² (292.9 kg/m²)
 Water depth: 19-7/16" (494 mm)
 Water capacity: 112.9 gal (427.4 L)
 Cutout: Drop-in, 71-1/2" x 35-1/2" (1816 mm x 902 mm)
 Electrical component rating: Blower: 220-240 V, 5 A, 50/60 Hz
 Blower speed: Variable
 Minimum flat for door: 2-3/4" (69 mm)

Notes

Measure your actual product for rough-in details. Install this product according to the installation instructions.

The hot water supply should be 70% of the capacity of the bath or greater. Installations will vary.

Kit is required for under-mount installations (sold separately).

If relocating the blower motor, do not relocate or alter the PVC tee or coiled flexible tubing connected to the blower. Follow the blower relocation instructions exactly. Provide access for servicing the blower.