

### Features

- 36" minimum base cabinet width
- Large/medium bowls
- 9" (229 mm) depth provides generous workspace
- Five oversized faucet holes
- Oversized holes allow for easy installation of faucets and accessories
- Bowl slopes toward drain to minimize water pooling
- Offset drains increase workspace in the sink and storage space underneath
- Includes K-6239 colander with integral cutting board, K-6194 utility rack with soaking cup, and K-9234 left-hand bottom sink rack

### Material

- KOHLER® enameled cast iron

### Installation

- Undermount

### Recommended Products/Accessories

- K-9234 Left-Bowl Sink Rack
- K-8801 Sink drain and strainer with tailpiece
- K-8799 Sink drain and strainer basket
- K-23726 Drain treatment
- K-23725 Cast iron cleaner
- 1411886 Undermount sink kit 23"

### Optional Products/Accessories

- K-11352 Disposal Flange with Stopper
- K-9000 P-Trap

### Included Components

- K-6194 Utility Rack With Soaking Cup
- K-6239 Colander with Cutting Board
- K-9234 Left-Bowl Sink Rack



### Codes/Standards









ASME A112.19.1/CSA B45.2

### KOHLER® Enameled Cast Iron Kitchen and Bathroom Sink Lifetime Limited Warranty

See website for detailed warranty information.

### Available Colors/Finishes

*Color tiles intended for reference only.*

Color	Code	Description
	0	White
	FF	Sea Salt™
	96	Biscuit
	NY	Dune
	95	Ice™ Grey
	58	Thunder™ Grey
	7	Black Black™
	TRF	Truffle

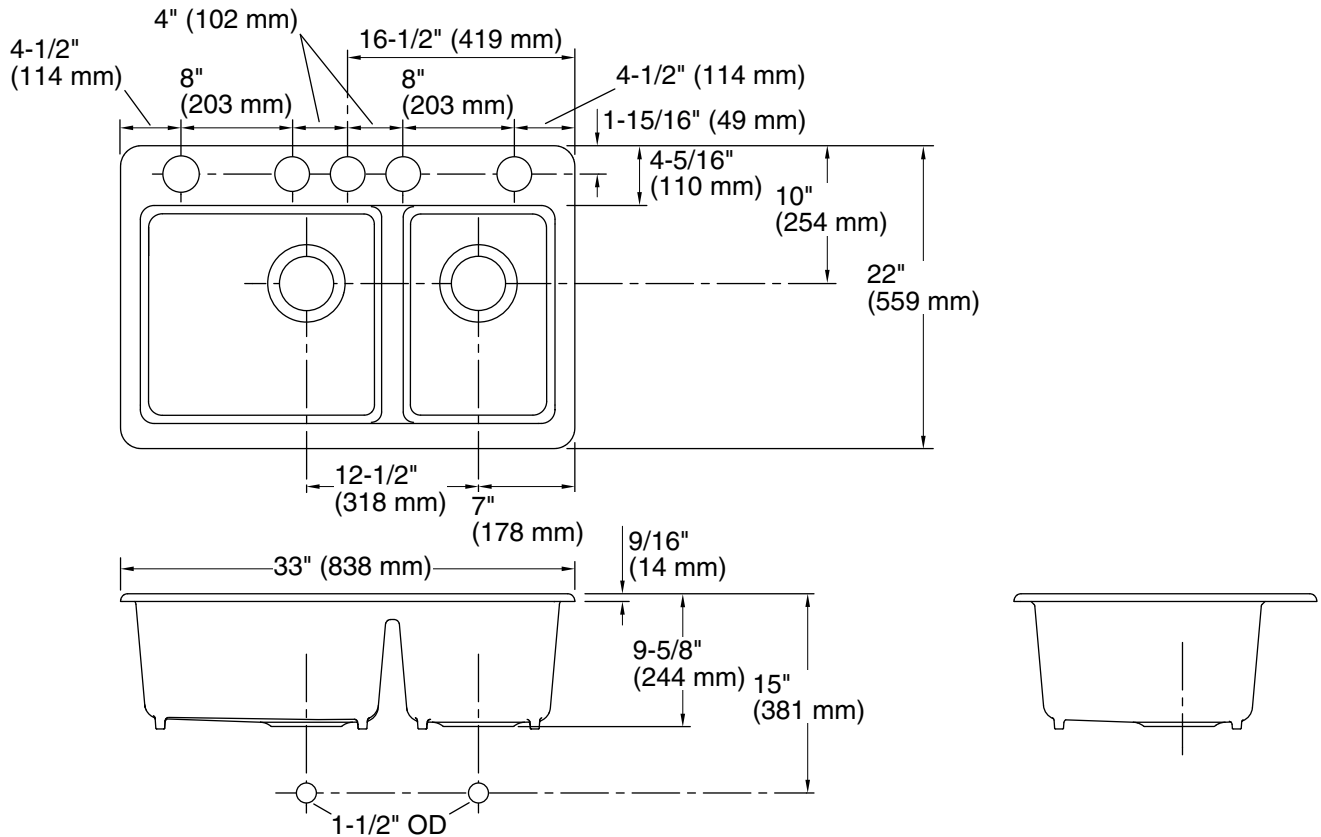

## Technical Information

All product dimensions are nominal.

Basin configuration: Large Bowl on Left

Center(s): 8" (203 mm)

Min. base cabinet width: 36" (914 mm)

Bowl area (Basin #1):  
Length: 17-9/16" (446 mm)  
Width: 15-13/16" (402 mm)  
Bowl depth: 9" (229 mm)  
Water depth: 9" (229 mm)

Bowl area (Basin #2):  
Length: 11-1/16" (281 mm)  
Width: 15-13/16" (402 mm)  
Bowl depth: 9" (229 mm)  
Water depth: 9" (229 mm)

Number of deck holes: 5

Drain hole: 3-7/8" (98 mm)

Template: 1166727-7, required, included

## Notes

Install this product according to the installation instructions.