

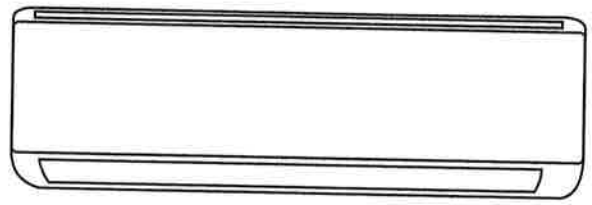

A HAVELLS Brand

SPLIT AIR CONDITIONER

# OWNER'S MANUAL



Please read this manual carefully before operating the machine

## CONTENTS

|                                 |    |
|---------------------------------|----|
| SAFETY PRECAUTIONS .....        | 1  |
| NAME OF PARTS .....             | 4  |
| REMOTE CONTROL .....            | 6  |
| OPERATION INSTRUCTIONS .....    | 13 |
| INSTALLATION PRECAUTIONS .....  | 14 |
| INDOOR UNIT INSTALLATION .....  | 15 |
| OUTDOOR UNIT INSTALLATION ..... | 20 |
| TEST OPERATION .....            | 23 |
| MAINTENANCE .....               | 25 |
| TROUBLESHOOTING .....           | 26 |

The design and specifications are subject to change without prior notice for product improvement. Consult with the sales agency or manufacturer for details.

The shape and position of buttons and indicators may vary according to the model, but their function are the same.

## SAFETY PRECAUTIONS

### SAFETY RULES AND RECOMMENDATIONS FOR THE INSTALLER

1. Read this guide before installing and using the appliance.
2. During the installation of the indoor and outdoor units, access to the working area should be forbidden to children. Unforeseeable accidents could happen.
3. Make sure that the base of the outdoor unit is firmly fixed.
4. Check that air cannot enter the refrigerant system and check for refrigerant leaks when moving the air conditioner.
5. Carry out a test cycle after installing the air conditioner and record the operating data.
6. Protect the indoor unit with a fuse of suitable capacity for the maximum input current or with another overload protection device.
7. Ensure that the mains voltage corresponds to that stamped on the rating plate. Keep the switch or power plug clean. Insert the power plug correctly and firmly into the socket, thereby avoiding the risk of electric shock or fire due to insufficient contact.
8. Check that the socket is suitable for the plug, otherwise have the socket changed.
9. The appliance must be fitted with means for disconnection from the supply mains having a contact separation in all poles that provide full disconnection under over voltage category III conditions, and these means must be incorporated in the fixed wiring in accordance with the wiring rules.
10. The air conditioner must be installed by professional or qualified persons.
11. Do not install the appliance at a distance of less than 50 cm from inflammable substances (alcohol, etc.) Or from pressurized containers (e.g. spray cans).
12. If the appliance is used in areas without the possibility of ventilation, precautions must be taken to prevent any leaks of refrigerant gas from remaining in the environment and creating a danger of fire.
13. The packaging materials are recyclable and should be disposed of in the separate waste bins. Take the air conditioner at the end of its useful life to a special waste collection center for disposal.
14. Only use the air conditioner as instructed in this booklet. These instructions are not intended to cover every possible condition and situation. As with any electrical household appliance, common sense and caution are therefore always recommended for installation, operation and maintenance.
15. The appliance must be installed in accordance with applicable national regulations.
16. Before accessing the terminals, all the power circuits must be disconnected from the power supply.
17. The appliance shall be installed in accordance with national wiring regulations.
18. This appliance can be used by children aged from 8 years and above and persons with reduced physical, sensory or mental capabilities or lack of experience and knowledge if they have been given supervision or instruction concerning use of the appliance in a safe way and understand the hazards involved. Children shall not play with the appliance. Cleaning and user maintenance shall not be made by children without supervision.

## SAFETY PRECAUTIONS

### SAFETY RULES AND RECOMMENDATIONS FOR THE INSTALLER

19. **D**o not try to install the conditioner alone, always contact specialized technical personnel.
20. **C**leaning and maintenance must be carried out by specialized technical personnel. In any case disconnect the appliance from the mains electricity supply before carrying out any cleaning or maintenance.
21. **E**nsure that the mains voltage corresponds to that stamped on the rating plate. Keep the switch or power plug clean. Insert the power plug correctly and firmly into the socket, thereby avoiding the risk of electric shock or fire due to insufficient contact.
22. **D**o not pull out the plug to switch off the appliance when it is in operation, since this could create a spark and cause a fire, etc.
23. **T**his appliance has been made for air conditioning domestic environments and must not be used for any other purpose, such as for drying clothes, cooling food, etc.
24. **A**lways use the appliance with the air filter mounted. The use of the conditioner without air filter could cause an excessive accumulation of dust or waste on the inner parts of the device with possible subsequent failures.
25. **T**he user is responsible for having the appliance installed by a qualified technician, who must check that it is earth in accordance with current legislation and insert a thermos magnetic circuit breaker.
26. **T**he batteries in the remote controller must be recycled or disposed of properly. For disposal of scrap batteries, please discard the batteries as sorted municipal waste at the accessible collection point.
27. **N**ever remain directly exposed to the flow of cold air for a long time. The direct and prolonged exposition to cold air could be dangerous for your health. Particular care should be taken in the rooms where there are children, old or sick people.
28. **I**f the appliance gives off smoke or there is a smell of burning, immediately cut off the power supply and contact the Service Center.
29. **T**he prolonged use of the device in such conditions could cause fire or electrocution.
30. **H**ave repairs carried out only by an authorised Service Centra of the manufacturer. Incorrect repair could expose the user to the risk of electric shock, etc.
31. **U**nhook the automatic switch if you foresee not to use the device for a long time. The airflow direction must be properly adjusted.
32. **T**he flaps must be directed downwards in the heating mode and upwards in the cooling mode.
33. **E**nsure that the appliance is disconnected from the power supply when it will remain inoperative for a long period and before carrying out any cleaning or maintenance.
34. **S**electing the most suitable temperature can prevent damage to the appliance.

## SAFETY PRECAUTIONS

### SAFETY RULES AND PROHIBITIONS

1. **D**o not bend, tug or compress the power cord since this could damage it. Electrical shocks or fire are probably due to a damaged power cord. Specialized technical personnel only must replace a damaged power cord.
2. **D**o not use extensions or gang modules.
3. **D**o not touch the appliance when barefoot or parts of the body are wet or damp.
4. **D**o not obstruct the air inlet or outlet of the indoor or the outdoor unit. The obstruction of these openings causes a reduction in the operative efficiency of the conditioner with possible consequent failures or damages.
5. **I**n no way alter the characteristics of the appliance.
6. **D**o not install the appliance in environments where the air could contain gas, oil or sulphur or near sources of heat.
7. **T**his appliance is not intended for use by persons (including children ) with reduced physical, sensory or mental capabilities, or lack of experience and knowledge, unless they have been given supervision or instruction concerning use of the appliance by a person responsible for their safety.
8. **D**o not climb onto or place any heavy or hot objects on top of the appliance.
9. **D**o not leave windows or doors open for long when the air conditioner is operating.
10. **D**o not direct the airflow onto plants or animals.
11. **A** long direct exposition to the flow of cold air of the conditioner could have negative effects on plants and animals.
12. **D**o not put the conditioner in contact with water. The electrical insulation could be damaged and thus causing electrocution.
13. **D**o not climb onto or place any objects on the outdoor unit.
14. **N**ever insert a stick or similar object into the appliance. It could cause injury.
15. **C**hildren should be supervised to ensure that they do not play with the appliance. If the supply cord is damaged, it must be replaced by the manufacturer, its service agent or similarly qualified persons in order to avoid a hazard.

## NAME OF PARTS

### Indoor Unit

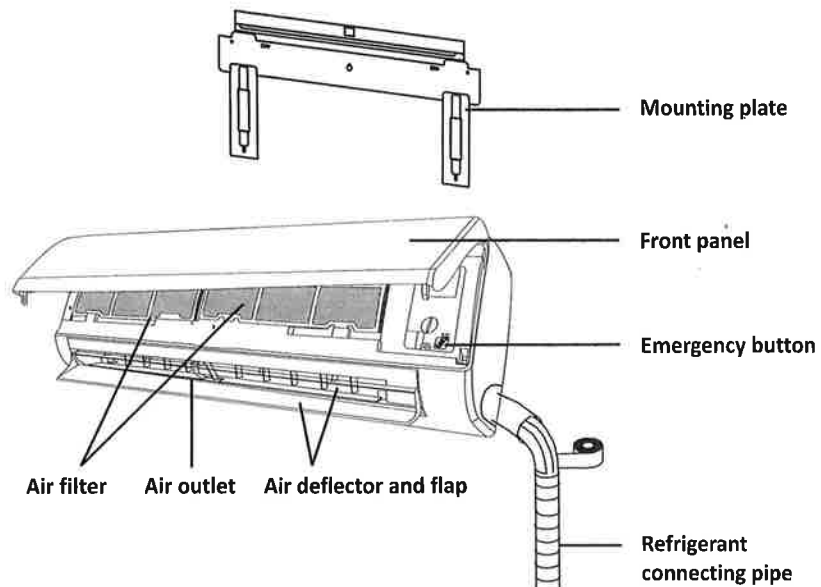

### Outdoor Unit

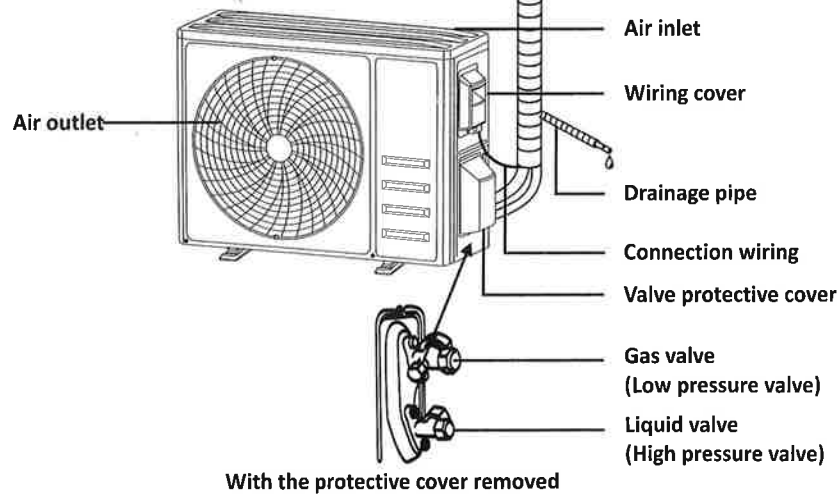

Note: This figure shown may be different from the actual object. Please take the latter as the standard.

## NAME OF PARTS

### Indoor Display

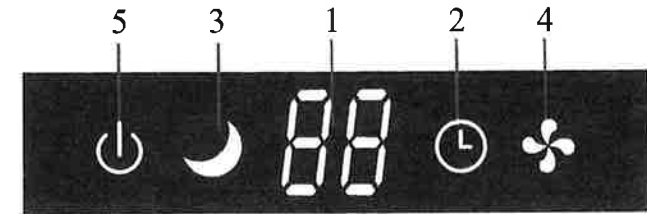

| No. | LED | Function  |
|-----|-----|---|
| 1   | 88  | Indicator for Timer, temperature and Error codes.   |
| 2   | 🕒   | Lights up during Timer operation.   |
| 3   | 🌙   | SLEEP mode  |
| 4   | 🌀   | The symbol appears when the unit is turned on, and disappear when the unit is turned off. |
| 5   | 🔌   | The symbol appears when power on.   |



The shape and position of switches and indicators may be different according to the model, but their function is the same.

## REMOTE CONTROL

### Remote control DISPLAY

| No. | Symbols | Meaning   |
|-----|---------|---|
| 1   |         | Battery indicator                                     |
| 2   |         | Auto Mode   |
| 3   |         | Cooling Mode  |
| 4   |         | Dry Mode  |
| 5   |         | Fan only Mode   |
| 6   |         | Heating Mode  |
| 7   |         | ECO Mode  |
| 8   |         | Timer   |
| 9   | 8.8 °E  | Temperature indicator                                 |
| 10  |         | Fan speed:<br>Auto/ low/ low-mid/ mid/ mid-high/ high |
| 11  |         | Mute function   |
| 12  |         | TURBO function  |
| 13  |         | Up-down auto swing                                    |
| 14  |         | Left-right auto swing                                 |
| 15  |         | SLEEP function  |
| 16  |         | Health function                                       |
| 17  |         | I FEEL function                                       |
| 18  | 8H      | 8°C heating function                                  |
| 19  |         | Signal indicator                                      |
| 20  |         | Gentle wind   |
| 21  |         | Child-Lock  |
| 22  |         | Display ON/OFF  |

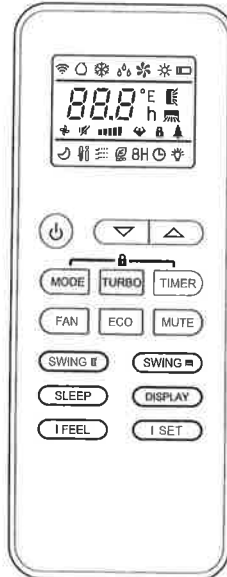
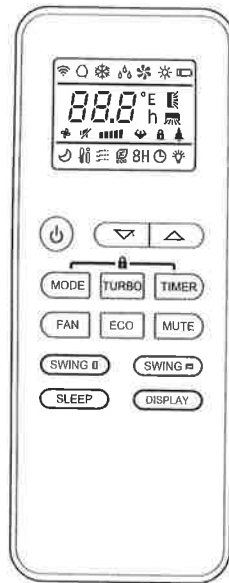

⚠ The display and some functions of the remote control may vary according to the model.

## REMOTE CONTROL

| No. | Button            | Function  |
|-----|-------------------|---|
| 1   |                   | To turn on/off the air conditioner.   |
| 2   |                   | To increase temperature, or Timer setting hours.  |
| 3   |                   | To decrease temperature, or Timer setting hours.  |
| 4   | MODE              | To select the mode of operation (AUTO, COOL, DRY, FAN, HEAT).   |
| 5   | ECO               | To activate/deactivate the ECO function.<br>Long press to activate/deactivate the 8°C heating function (depending on models). |
| 6   | TURBO             | To activate/deactivate the TURBO function.  |
| 7   | FAN               | To select the fan speed of auto/low/mid/high.   |
| 8   | TIMER             | To set the time for timer on/off.   |
| 9   | SLEEP             | To switch-on/off the function SLEEP.  |
| 10  | DISPLAY           | To switch-on/off the LED display.   |
| 11  | SWING             | To stop or start horizontal flaps louver movement or set the desired up/down air flow direction                               |
| 12  | SWING             | To stop or start vertical deflectors louver movement or set the desired left/right air flow direction                         |
| 13  | I FEEL            | To switch-on/off the I FEEL function.   |
| 14  | MUTE              | To switch-on/off the MUTE function.<br>Long press to activate/deactivate the GEN function (depending on models).              |
| 15  | MODE + TIMER      | To activate/deactivate the CHILD-LOCK function.   |
| 16  | SWING  +<br>SWING | To activate/deactivate the SELF-CLEAN function (depending on models).   |
| 17  | FAN + MUTE        | To activate/deactivate the GENTLE WIND function (depending on models).  |
| 18  | SLEEP + DISPLAY   | To activate/deactivate the HEALTH function (depending on models).   |
| 19  | I SET             | To memory the setting temperature, setting mode and setting fan speed as you need   |

⚠ The display and some functions of the remote control may vary according to the model.

⚠ The shape and position of buttons and indicators may vary according to the model, but their function is the same.

⚠ The unit confirms the correct reception of each button with the beep.





## REMOTE CONTROL

### TIMER function ---- TIMER ON

**TIMER**  To automatic switch on the appliance.

When the unit is switch-off, you can set the TIMER ON.

To set the time of automatic switch-on as below:

1. Press **TIMER** button first time to set the switch-on,  and  will appear on the remote display and flashes.
2. Press  $\wedge$  or  $\vee$  to button to set desired Timer-on time. Each time you press the button, the time increases/decreases by half an hour between 0 and 10 hours and by one between 10 and 24 hours.
3. Press **TIMER** button second time to confirm.
4. After Timer-on setting, set the needed mode (Cool/ Heat/ Auto/ Fan/ Dry), by press the **MODE** button. And set the needed fan speed, by press **FAN** button. And press  $\wedge$  or  $\vee$  to set the needed operation temperature.

CANCEL it by press **TIMER** button.

### TIMER function ---- TIMER OFF

**TIMER**  To automatic switch off the appliance.

When the unit is switch-on, you can set the TIMER OFF.

To set the time of automatic switch-off, as below:





1. Confirm the appliance is ON.
2. Press the **TIMER** button at first time to set the switch-off.  
Press  $\wedge$  or  $\vee$  to set the needed timer.
3. Press **TIMER** button at the second time to confirm.



CANCEL it by press **TIMER** button.

**Note:** All programming should be operated within 5 seconds, otherwise the setting will be cancelled.

### SWING function



1. Press the **button** SWING to activate the louver, to swing from up to down, the  will appear on the remote display.  
Press again to stop the swing movement at the current angle.
  - 1.1 Press  to activate the horizontal flaps to swing from up to down, the  will appear on the remote display.  
Press again to stop the swing movement at the current angle.
  - 1.2 Press  to activate the vertical deflectors to swing from left to right, the  will appear on the remote display.  
Press again to stop the swing movement at the current angle.
2. If the vertical deflectors are positioned manually which placed under the flaps, they allow to move the air flow direct to rightward or leftward.
3. For some inverter heating models, press horizontal SWING and vertical SWING together button at the same time, it will activate the Self-Clean function.

-  This adjustment must be done while the appliance is switched off.
-  Never position "Flaps" manually, the delicate mechanism might seriously damaged!
-  Never put fingers, sticks or other objects into the air inlet or outlet vents. Such accidental contact with live parts might cause unforeseeable damage or injury.

### TURBO function



To activate turbo function, press the **TURBO** button, and  will appear on the display. Press again to cancel this function.  
In COOL/ HEAT mode, when you select TURBO feature, the appliance will turn to quick COOL or quick HEAT mode, and operate the highest fan speed to blow strong airflow.

## REMOTE CONTROL

### MUTE function



1. Press **MUTE** button to active this function, and  will appears on the remote display. Do it again to deactivate this function.
2. When the MUTE function runs, the remote controller will display the auto fan speed, and the indoor unit will operate at lowest fan speed to be quiet feeling.
3. When press FAN/ TURBO/ SLEEP button, the MUTE function will be cancel. MUTE function can not be activated under dry mode.

### SLEEP function

**SLEEP**  Pre-setting automatic operating program.

Press **SLEEP** button to activate the SLEEP function, and  appears on the display. Press again to cancel this function.

After 10 hours running in sleep mode, the air conditioner will change to the previous setting mode.

### I FEEL function (Optional)



Press **I FEEL** button to activate the function, the  will appear on the remote display. Do it again to deactivate this function.

This function enables the remote control to measure the temperature at its current location, and send this signal to the air conditioner to optimize the temperature around you and ensure the comfort.  
It will automatically deactivate 2 hours later.

### ECO function

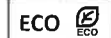

In this mode the appliance automatically sets the operation to save energy.

Press the **ECO** button, the  appears on the display, and the appliance will run in ECO mode. Press again to cancel it.

**Note:** The ECO function is available in both COOLING and HEATING modes.

### DISPLAY function (Indoor display)

**DISPLAY** Switch ON/OFF the LED display on panel.

Press **DISPLAY** button to switch off the LED display on the panel. Press again to switch on the LED display.

### GEN function (Optional)

1. Turn on the indoor unit at first, and long press **MUTE** button 3 seconds to active, and do it again to deactivate this function.
2. Under this function, short press **MUTE** button to select the General type L3 - L2 - L1 - OF.
3. Select OF and wait 2 seconds to exit it.

\* If the indoor unit displays "OA", please use the remote to raise the operating gear of the GEN mode, and the compressor will restart after stopping for 3 minutes.

## REMOTE CONTROL

### SELF-CLEAN function (Optional)

Only optional for some heating pump inverter appliance.

To active this function, turn off the indoor unit at first, then press and button at the same time toward the indoor unit, until hear a beep, and [AC] will appear on the remote controller display and the indoor LED display.

1. This function helps carry away the accumulated dirt, bacteria, etc from the indoor evaporator.
2. This function will run about 30 minutes, and it will return to the pre-setting mode. You can press button to cancel this function during the process.  
You will hear 2 beeps when it's finished or cancelled.

⚠ It's normal if there is some noise during this function process, as plastic materials expand with heat and contract with cold.

⚠ We suggest operating this function at the following ambient conditions to avoid certain safety protection features.

|              |                                 |
|--------------|---------------------------------|
| Indoor unit  | Temp < 86°F (30°C)              |
| Outdoor unit | 41°F (5°C) < Temp < 86°F (30°C) |

⚠ It's suggested to utilize this function every 3 months.

### 8°C heating function (Optional)

1. Long press button over 3 seconds to active this function, and ( ) will appear on the remote display.  
Do it again to deactivate this function.
2. This function will auto start the heating mode when the room temperature is lower than 8°C (46°F), and it will return to standby if the temperature reaches 9°C (48°F).
3. If the room temperature is higher than 18°C (64°F), the appliance will cancel this function automatically.

### Gentle Wind function (Optional)

1. Turn on the indoor unit, and change to COOL mode, then long press and button together 3 seconds to active this function, will appear on the display.  
Do it again to deactivate it.
2. This function will auto close the vertical flaps, and give you the comfortable gentle wind feeling.

### Health function (Optional)

1. Turn on the indoor unit at first, and long press and button together 3 seconds to active this function, will appear on the display.  
Do it again to deactivate it.
2. When the HEALTH function is initiated, the Ionizer/ Plasma/ Bipolar Ionizer/ UVC Lights (depending on models) will be energized and running.

### I SET function (Optional)

Remember your favorite setting and run into it by press One button

Remember the favorite setting:

1. In each mode (COOLING/ HEATING/ FAN/ DRY), long press " I SET " button over 3 seconds to remember it;
  2. When "AU" flashing appears on the remote controller display, that means the remote controller remember your favorite setting;
- \* Press any button to quit, and you can reset it by repeat 1, 2 operation.

Run into the favorite setting:

1. In each mode (COOLING/ HEATING/ FAN/ DRY), one press " I SET " button to active;
2. The appliance will run as your favorite setting and you will see [AU] flashing on the remote controller;
3. Press it again or other buttons to cancel this function.

## OPERATION INSTRUCTIONS

- ⓘ Attempt to use the air conditioner under the temperature beyond the specified range may cause the air conditioner protection device to start and the air conditioner may fail to operate. Therefore, try to use the air conditioner in the following temperature conditions.

Fixed air conditioner:

| MODE                | Heating              | Cooling  | Dry |
|---------------------|----------------------|--|-----|
| Room temperature    | 0°C~27°C(32°F~80°F)  | 17°C~32°C(63°F~90°F)   |     |
| Outdoor temperature | -7°C~24°C(19°F~75°F) | T1 climate: 15°C~43°C(59°F~109°F)<br>T3 climate: 15°C~52°C(59°F~125°F) |     |

Inverter air conditioner:

| MODE                | Heating   | Cooling  | Dry |
|---------------------|---|--|-----|
| Room temperature    | 0°C~27°C(32°F~80°F)   | 17°C~32°C(63°F~90°F)   |     |
| Outdoor temperature | -15°C~24°C(5°F~75°F)<br>(Low temperature heating: -20°C~24°C (-4°F~75°F)) | T1 climate: 15°C~50°C(59°F~122°F)<br>(Low temperature cooling: -15°C~50°C(5°F~122°F))<br>T3 climate: 15°C~55°C(59°F~131°F) |     |

With the power supply connected, restart the air conditioner after shutdown, or switch it to other mode during operation, and the air conditioner protection device will start. The compressor will resume operation after 3 minutes.

- ⓘ Characteristics of heating operation (applicable to Heating pump)

**Preheating:**

When the heating function is enabled, the indoor unit will take 2~5 minutes for preheating, after that the air conditioner will start heating and blows warm air.

**Defrosting:**

During heating, when the outdoor unit frosted, the air conditioner will enable the automatic defrosting function to improve the heating effect. During defrosting, the indoor and outdoor fans stop running. The air conditioner will resume heating automatically after defrosting finish.

- ⓘ Emergency button:

Open the panel and find the emergency button on the electronic control box when the remote controller fails. (Always press the emergency button with insulation material.)

| Current status                  | Operation                                     | Respond                      | Enter mode   |
|---------------------------------|---|------------------------------|--------------|
| Standby                         | Press the emergency button once               | It beeps briefly once.       | Cooling mode |
| Standby (Only for heating pump) | Press the emergency button twice in 3 seconds | It beeps briefly twice.      | Heating mode |
| Running                         | Press the emergency button once               | It keeps beeping for a while | Off mode     |

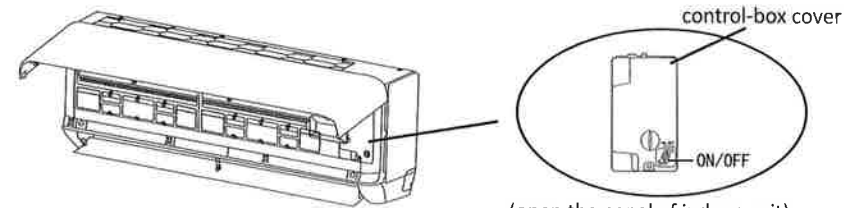

(open the panel of indoor unit)



## INSTALLATION PRECAUTIONS

### Pipe Length and Additional Refrigerant

| Inverter Models Capacity (Btu/h)                                 | 9K-12K    |           | 18K-36K   |           |
|--|-----------|-----------|-----------|-----------|
| Length of pipe with standard charge                              | 5m/16ft   | 5m/16ft   | 5m/16ft   | 5m/16ft   |
| Length of pipe with standard charge (Like: North American, etc.) | 7.5m/24ft | 7.5m/24ft | 7.5m/24ft | 7.5m/24ft |
| Maximum distance between indoor and outdoor unit                 | 15m/49ft  | 15m/49ft  | 25m/82ft  | 25m/82ft  |
| Additional refrigerant charge                                    | 20g/m     | 15g/m     | 30g/m     | 25g/m     |
| Max. diff. in level between indoor and outdoor unit              | 10m/32ft  | 10m/32ft  | 10m/32ft  | 10m/32ft  |
| Type of refrigerant  | R22/R410A | R32       | R22/R410A | R32       |

| ON-OFF Models Capacity (Btu/h)                      | 9K-12K    |          | 18K-36K   |          |
|---|-----------|----------|-----------|----------|
| Length of pipe with standard charge                 | 5m/16ft   | 5m/16ft  | 5m/16ft   | 5m/16ft  |
| Maximum distance between indoor and outdoor unit    | 15m/49ft  | 15m/49ft | 15m/49ft  | 15m/49ft |
| Additional refrigerant charge                       | 20g/m     | 15g/m    | 30g/m     | 25g/m    |
| Max. diff. in level between indoor and outdoor unit | 5m/16ft   | 5m/16ft  | 5m/16ft   | 5m/16ft  |
| Type of refrigerant                                 | R22/R410A | R32      | R22/R410A | R32      |

### Torque Parameters

| PIPE Size             | Newton meter [N x m] | Pound-force foot (lbf-ft) | Kilogram-force meter (kgf-m) |
|-----------------------|----------------------|---------------------------|------------------------------|
| 1/4 " ( $\phi$ 6.35)  | 18 - 20              | 24.4 - 27.1               | 2.4 - 2.7                    |
| 3/8 " ( $\phi$ 9.52)  | 30 - 35              | 40.6 - 47.4               | 4.1 - 4.8                    |
| 1/2 " ( $\phi$ 12)    | 45 - 50              | 61.0 - 67.7               | 6.2 - 6.9                    |
| 5/8 " ( $\phi$ 15.88) | 60 - 65              | 81.3 - 88.1               | 8.2 - 8.9                    |

### Dedicated Distribution Device and Wire for Air Conditioner

| Min. Circuit Ampacity of Air Conditioner (A) | Minimum Wire Cross-sectional Area (mm <sup>2</sup> ) | Specification of Socket or Switch (A) | Fuse Specification (A) |
|--|--|---------------------------------------|------------------------|
| $\leq 8$                                     | 0.75   | 15                                    | 15                     |
| $> 8$ and $\leq 10$                          | 1.0  | 15                                    | 15                     |
| $> 10$ and $\leq 15$                         | 1.5  | 20                                    | 25                     |
| $> 15$ and $\leq 24$                         | 2.5  | 25                                    | 40                     |
| $> 24$ and $\leq 28$                         | 4.0  | 35                                    | 45                     |
| $> 28$ and $\leq 32$                         | 6.0  | 40                                    | 55                     |

**⚠ Note:** This table is only for reference, the installation shall meet the requirements of local laws and regulations.

## INDOOR UNIT INSTALLATION

### Step1: Select Installation location

- 1.1 Ensure the installation complies with the installation minimum dimensions (defined below) and meets the minimum and maximum connecting piping length and maximum change in elevation as defined in the System Requirements section.
- 1.2 Air inlet and outlet will be clear of obstructions, ensuring proper airflow throughout the room.
- 1.3 Condensate can be easily and safely drained.
- 1.4 All connections can be easily made to outdoor unit.
- 1.5 Indoor unit is out of reach of children.
- 1.6 A mounting wall strong enough to withstand four times the full weight and vibration of the unit.
- 1.7 Filter can be easily accessed for cleaning.
- 1.8 Leave enough free space to allow access for routine maintenance.
- 1.9 Install at least 10 ft. (3 m) away from the antenna of TV set or radio. Operation of the air conditioner may interfere with radio or TV reception in areas where reception is weak. An amplifier may be required for the affected device.
- 1.10 Do not install in a laundry room or by a swimming pool due to the corrosive environment.
- 1.11 For ETL certification area, Caution: Mount with the lowest moving parts at least 8 ft. (2.4 m) above floor or grade level.

### Minimum Indoor Clearances

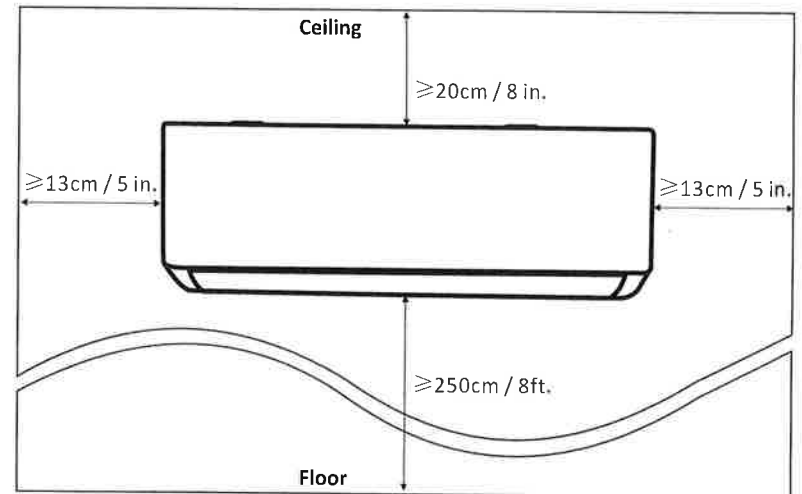

# INDOOR UNIT INSTALLATION

## Step2: Install Mounting Plate

- 2.1 Take the mounting plate from the back of indoor unit.
- 2.2 Ensure to meet the minimum installation dimension requirements as step 1, according to the size of mounting plate, determine the position and stick the mounting plate close to the wall.
- 2.3 Adjust the mounting plate to a horizontal state with a spirit level, then mark out the screw hole positions on the wall.
- 2.4 Put down the mounting plate and drill holes in the marked positions with drill.
- 2.5 Insert expansion rubber plugs into the holes, then hang the mounting plate and fix it with screws.

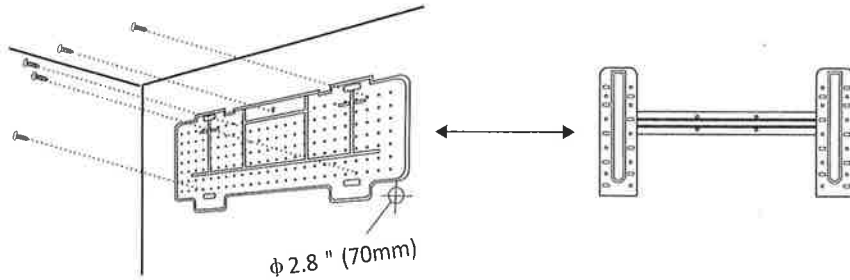

### Note:

- (I) Make sure the mounting plate is firm enough and flat against the wall after installation.
- (II) This figure shown may be different from the actual object, please take the latter as the standard.

## Step3: Drill Wall Hole

- A hole in the wall should be drilled for refrigerant piping, the drainage pipe, and connecting cables.
- 3.1 Determine the location of wall-hole base on the position of mounting plate.
  - 3.2 The hole should be have a 70mm diameter at least and a small oblique angle to facilitate drainage.
  - 3.3 Drill the wall hole with 70mm core drill and with small oblique angle lower than the indoor end about 5mm to 10mm.
  - 3.4 Place the wall sleeve and wall sleeve cover(both are optional parts) to protect the connection parts.

### Caution:

When drill the wall hole, maker sure to avoid wires, plumbing and other sensitive components.

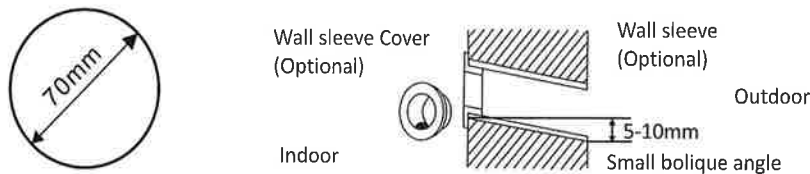

# INDOOR UNIT INSTALLATION

## Step4: Connecting Refrigerant Pipe

- 4.1 According to the wall hole position, select the appropriate piping mode.  
There are three optional piping modes for indoor units as shown in the figure below:  
In Piping Mode 1 or Piping Mode 3, a notch should be made by using scissors to cut the plastic sheet of piping outlet and cable outlet on the corresponding side of the indoor unit.

**Note:** When cutting off the plastic sheet at the outlet, the cut should be trimmed to smooth.

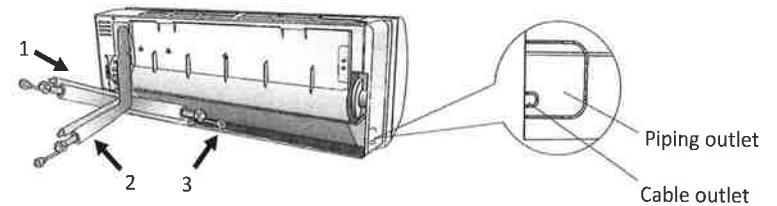

- 4.2 Bending the connecting pipes with the port facing up as shown in the figure.

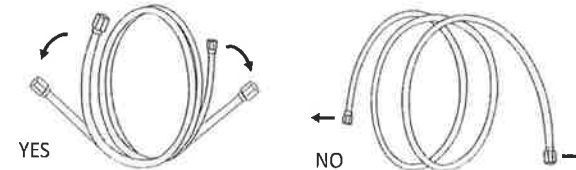

- 4.3 Take off the plastic cover in the pipe ports and take off the protective cover on the end of piping connectors.
- 4.4 Check whether there is any sundry on the port of the connecting pipe and make ensure the port is clean.
- 4.5 After align the center, rotate the nut of the connecting pipe to tighten the nut as tightly as possible by hand.
- 4.6 Use a torque wrench to tighten it according to the torque values in the torque requirements table; (Refer to the torque requirements table on section **INSTALLATION PRECAUTIONS**)
- 4.7 Wrap the joint with the insulation pipe.

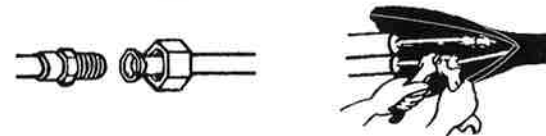

## INDOOR UNIT INSTALLATION

### Step5: Connect Drainage Hose

#### 5.1 Adjust the drainage hose(if applicable)

In some model, both sides of the indoor unit are provided with drainage ports, you can choose one of them to attach the drainage hose. And plug the unused drain port with the rubber attached in one of the ports.

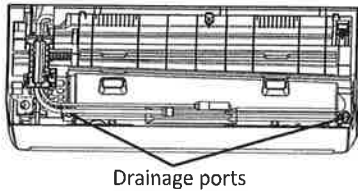

5.2 Connect the drainage hose to the drainage port, ensure the joint is firm and the sealing effect is good.

5.3 Wrap the joint firmly with teflon tape to ensure no leaks.

**Note:** Make sure there is no twists or dents, and the pipes should be placed obliquely downward to avoid blockage, to ensure proper drainage.

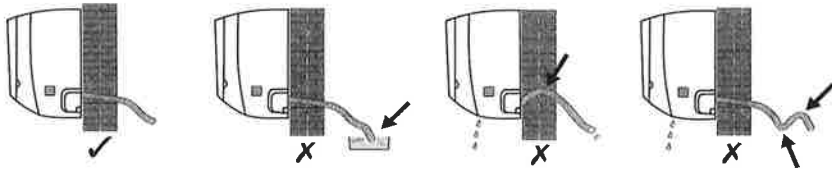

### Step6: Connect Wiring

6.1 Choose the right cables size determined by the maximum operating current on the nameplate. (Check the cables size refer to section **INSTALLATION PRECAUTIONS**)

6.2 Open the front panel of indoor unit.

6.3 Use a screwdriver, open the electric control box cover, to reveal the terminal block.

6.4 Unscrew the cable clamp.

6.5 Insert one end of the cable into the position of control box from the back of the right end of the indoor unit.

6.6 Connect the wires to corresponding terminal according to the wiring diagram on the electric control box cover. And make sure that they are well connected.

6.7 Screw the cable clamp to fasten the cables.

6.8 Reinstall the electric control box cover and front panel.

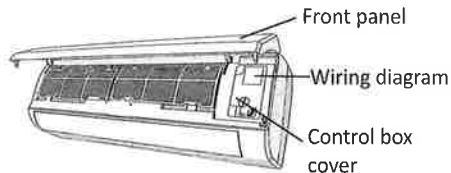

## INDOOR UNIT INSTALLATION

### Step7: Wrap Piping and Cable

After the refrigerant pipes, connecting wires and drainage hose are all installed, in order to save space, protect and insulate them, it must be bundle with insulating tape before passing them through the wall hole.

7.1 Arrange the pipes ,cables and drainage hose well as the following picture.

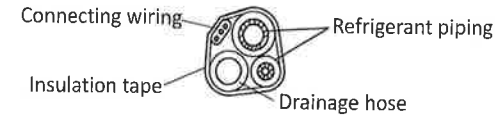

**Note:** (I) Make sure the drainage hose is at the bottom.

(II) Avoid crossing and bending of parts.

7.2 Using the insulating tape wrap the refrigerant pipes, connecting wires and drainage hose together tightly.

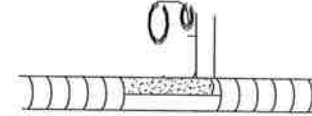

### Step8: Mount Indoor Unit

8.1 Slowly pass the refrigerant pipes, connecting wires and drainage hose wrapped bundle through the wall hole.

8.2 Hook the top of indoor unit on the mounting plate.

8.3 Apply slight pressure to the left and right sides of the indoor unit, make sure the indoor unit is hooked firmly.

8.4 Push down the bottom of indoor unit to let the snaps onto the hooks of the mounting plate, and make sure it is hooked firmly.

**Sometimes, if the refrigerant pips were already embedded in the wall, or if you want to connecting the pips and wires on the wall, do as below:**

(I) Hook the top of the indoor unit on the mounting plate without piping and wiring.

(II) Lift the indoor unit opposite the wall, unfold the bracket on the mounting plate, and use this bracket to prop up the indoor unit, there will be a big space for operation.

(III) Do the refrigerant piping, wiring, connect drainage hose, and wrap them as **Step 4 to 7**.

## OUTDOOR UNIT INSTALLATION

### Step1: Select Installation Location

Select a site that allows for the following:

- 1.1 Do not install the outdoor unit near sources of heat, steam or flammable gas.
- 1.2 Do not install the unit in too windy or dusty places.
- 1.3 Do not install the unit where people often pass. Select a place where the air discharge and operating sound will not disturb the neighbors.
- 1.4 Avoid installing the unit where it will be exposed to direct sunlight ( other wise use a protection, if necessary, that should not interfere with the air flow).
- 1.5 Reserve the spaces as shown in the picture for the air to circulate freely.
- 1.6 Install the outdoor unit in a safe and solid place.
- 1.7 If the outdoor unit is subject to vibration, place rubber blankets onto the feet of the unit.

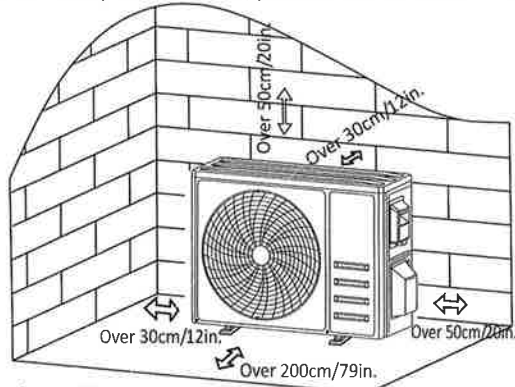

### Step2: Install Drainage Hose

- 2.1 This step only for heating pump models.
- 2.2 Insert the drainage joint to the hole at the bottom of the outdoor unit.
- 2.3 Connect the drainage hose to the joint and make the connection well enough.

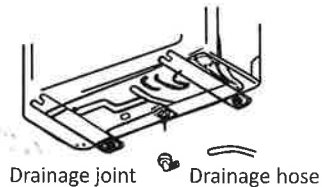

### Step3: Fix Outdoor Unit

- 3.1 According to the outdoor unit installation dimensions to mark the installation position for expansion bolts .
- 3.2 Drill holes and clean the concrete dust and place the bolts .
- 3.3 If applicable install 4 rubber blankets on the hole before place the outdoor unit (Optional). This will reduce vibrations and noise.
- 3.4 Place the outdoor unit base on the bolts and pre-drilled holes.
- 3.5 Use wrench to fix the outdoor unit firmly with bolts.

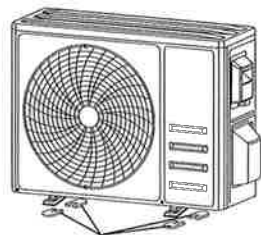

Install 4 rubber blankets (Optional)

#### Note:

The outdoor unit can be fixed on a wall-mounting bracket. Follow the instruction of the wall-mounting bracket to fix the wall-mounting bracket on the wall, and then fasten the outdoor unit on it and keep it horizontal. The wall-mounting bracket must be able to support at least 4 times of the weight of outdoor unit.

## OUTDOOR UNIT INSTALLATION

### Step4: Install Wiring

- 4.1 Use a phillips screwdriver to unscrew wiring cover, grasp and press it down gently to take it down,
- 4.2 Unscrew the cable clamp and take it down.
- 4.3 According to the wiring diagram pasted inside the wiring cover, connect the connecting wires to the corresponding terminals, and ensure all connections are firmly and securely.
- 4.4 Reinstall the cable clamp and wiring cover.

**Note:** When connecting the wires of indoor and outdoor units, the power should be cut off.

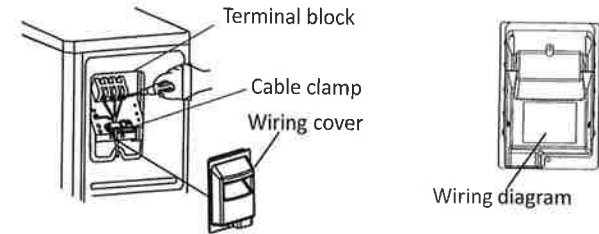

### Step5: Connecting Refrigerant Pipe

- 5.1 Unscrews the valve cover, grasp and press it down gently to take it down(if the valve cover is applicable).
- 5.2 Remove the protective caps from the end of valves.
- 5.3 Take off the plastic cover in the pipe ports and check whether there is any sundry on the port of the connecting pipe and make ensure the port is clean.
- 5.4 After align the center, rotate the flare nut of the connecting pipe to tighten the nut as tightly as possible by hand.
- 5.5 Use a spanner hold the body of the valve and use a torque wrench to tighten the flare nut according to the torque values in the torque requirements table. (Refer to the torque requirements table on section **INSTALLATION PRECAUTIONS**)

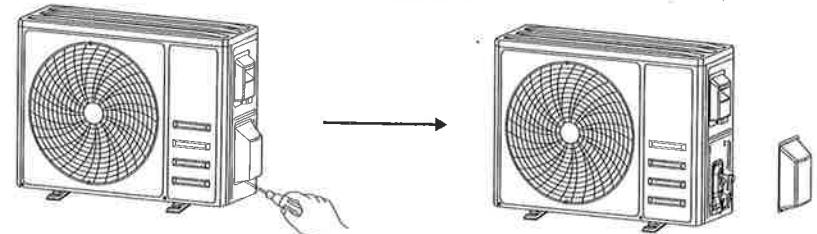

Take down the valve cover

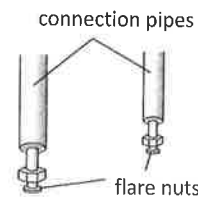

## OUTDOOR UNIT INSTALLATION

### Step6: Vacuum Pumping

- 6.1 Use a spanner to take down the protective caps from the service port, low pressure valve and high pressure valve of the outdoor unit.
- 6.2 Connect the pressure hose of manifold gauge to the service port on the outdoor unit low pressure valve.
- 6.3 Connect the charge hose from the manifold gauge to the vacuum pump.
- 6.4 Open the low pressure valve of the manifold gauge and close the high pressure valve.
- 6.5 Turn on the vacuum pump to vacuum the system.
- 6.6 The vacuum time should not be less than 15 minutes, or make sure the compound gauge indicates  $-0.1$  MPa ( $-76$  cmHg)
- 6.7 Close the low pressure valve of the manifold gauge and turn off the vacuum.
- 6.8 Hold the pressure for 5 minutes, make sure that the rebound of compound gauge pointer does not exceed  $0.005$  MPa.
- 6.9 Open the low pressure valve counterclockwise for  $1/4$  turn with hexagonal wrench to let a little refrigerant fill in the system, and close the low pressure valve after 5 seconds and quickly remove the pressure hose.
- 6.10 Check all indoor and outdoor joints for leakage with soapy water or leak detector.
- 6.11 Fully open the low pressure valve and high pressure valve of the outdoor unit with hexagonal wrench.
- 6.12 Reinstall the protective caps of the service port, low pressure valve and high pressure valve of the outdoor unit.
- 6.13 Reinstall the valve cover.

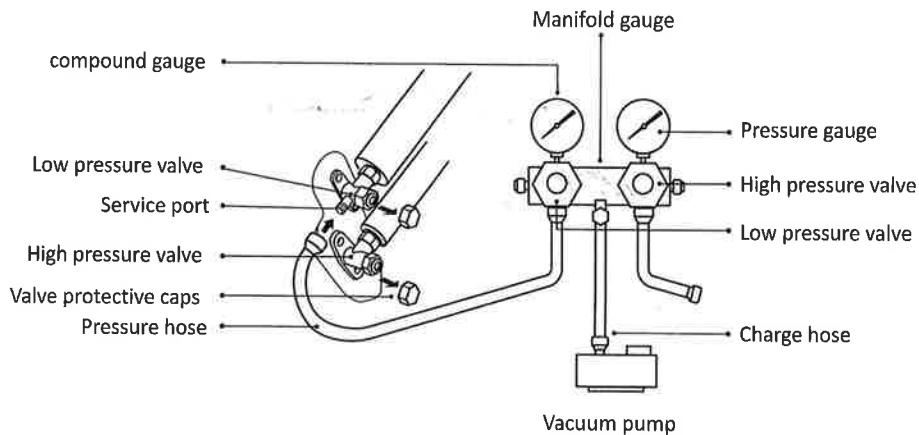

## TEST OPERATION

### Inspections Before Test Run

Do the following checks before test run.

| Description                    | Inspection method  |
|--------------------------------|--|
| Electrical safety inspection   | <ul style="list-style-type: none"> <li>• Check whether the power supply voltage complies with specification.</li> <li>• Check whether there is any wrong or missing connection between the power lines, signal line and earth wires.</li> <li>• Check whether the earth resistance and insulation resistance comply with requirements.</li> </ul>  |
| Installation safety inspection | <ul style="list-style-type: none"> <li>• Confirm the direction and smoothness of drainage pipe.</li> <li>• Confirm that the joint of refrigerant pipe is installed completely.</li> <li>• Confirm the safety of outdoor unit, mounting plate and indoor unit installation.</li> <li>• Confirm that the valves are fully open.</li> <li>• Confirm that there are no foreign objects or tools left inside the unit.</li> <li>• Complete installation of indoor unit air inlet grille and panel.</li> </ul>   |
| Refrigerant leakage detection  | <ul style="list-style-type: none"> <li>• The piping joint, the connector of the two valves of the outdoor unit, the valve spool, the welding port, etc., where leakage may occur.</li> <li>• Foam detection method:<br/>Apply soapy water or foam evenly on the parts where leakage may occur, and observe whether bubbles appear or not, if not, it indicates that the leakage detection result is safe.</li> <li>• Leak detector method:<br/>Use a professional leak detector and read the instruction of operation, detect at the position where leakage may occur.</li> <li>• The duration of leak detection for each position should last for 3 minutes or more;<br/>If the test result shows that there is leakage, the nut should be tightened and tested again until there is no leakage;<br/>After the leak detection is completed, wrap the exposed pipe connector of indoor unit with thermal insulation material and wrap with insulation tape.</li> </ul> |

## TEST OPERATION



### Test Run Instruction

1. Turn on the power supply.
2. Press the ON/OFF button on the remote controller to turn on the air conditioner.
3. Press the Mode button to switch the mode COOL and HEAT.  
In each mode set as below:  
COOL-Set the lowest temperature  
HEAT-Set the highest temperature
4. Run about 8 minutes in each mode and check all functions are properly run and respond the remote controller. Functions check as recommended:
  - 4.1 If the outlet air temperature respond the cool and heat mode
  - 4.2 If the water drains properly from the drainage hose
  - 4.3 If the Louver and deflectors(optional) rotate properly
5. Observe the test run state of the air conditioner at least 30 minutes.
6. After the successfully test run, return the normal setting and press ON/OFF button on the remote controller to turn off the unit.
7. Inform the user to read this manual carefully before use, and demonstrate to the user how to use the air conditioner, the necessary knowledge for service and maintenance, and the reminder for storage of accessories.

### Note:

If the ambient temperature is excess the range refer to section OPERATION INSTRUCTIONS, and it can not run COOL or HEAT mode, lift the front panel and refer to the emergency button operation to run the COOL and HEAT mode.

## MAINTENANCE

|                                |  |
|--------------------------------|--|
| <b>Warning</b>                 | <ul style="list-style-type: none"> <li>• When cleaning, you must shut down the machine and cut off the power supply for more than 5 minutes.</li> <li>• Under no circumstances should the air conditioner be flushed with water.</li> <li>• Volatile liquid (e.g. thinner or gasoline) will damage the air conditioner, so only use soft dry cloth or wet cloth dipped with neutral detergent to clean the air conditioner.</li> <li>• Pay attention to cleaning the filter screen regularly to avoid dust covering which will affect the filter screen effect. When the operating environment is dusty, the cleaning frequency should be increased appropriately.</li> <li>• After removing the filter screen, do not touch the fins of the indoor unit to avoid scratching.</li> </ul> |
| <b>Clean the unit</b>          | <div style="text-align: center;">  <p>Wring it dry    Gentle wipe the unit surface</p> </div> <p>Tip: Wipe frequently to keep air conditioner clean and good appearance .</p>   |
| <b>Clean the filter</b>        | <div style="text-align: center;">  <p>Take out the filter from the unit    Clean the filter with soapy water and air dry it    Replace the filter</p> </div> <p>Tip: When you find accumulated dust in the filter, please clean the filter in time to ensure the clean, healthy and efficient operation inside the air conditioner.</p>   |
| <b>Service and maintenance</b> | <ul style="list-style-type: none"> <li>• When the air conditioner is not in use for a long time, do the following work:<br/>Take out the batteries of the remote controller and disconnect the power supply of the air conditioner.</li> <li>• When starting to use after long-term shutdown:             <ol style="list-style-type: none"> <li>1. Clean the unit and filter screen;</li> <li>2. Check whether there are obstacles at the air inlet and outlet of indoor and outdoor units;</li> <li>3. Check whether the drain pipe is unobstructed;</li> </ol>             Install the batteries of the remote controller and check whether the power is on.           </li> </ul>  |

## TROUBLESHOOTING

| MALFUNCTION  | POSSIBLE CAUSES   |
|--|---|
| The appliance does not operate   | Power failure/plug pulled out.  |
|  | Damaged indoor/outdoor unit fan motor.  |
|  | Faulty compressor thermomagnetic circuit breaker.   |
|  | Faulty protective device or fuses.  |
|  | Loose connections or plug pulled out.   |
|  | It sometimes stops operating to protect the appliance.  |
|  | Voltage higher or lower than the voltage range.   |
|  | Active TIMER-ON function.   |
| Strange odor   | Dirty air filter.   |
| Noise of running water   | Back flow of liquid in the refrigerant circulation.   |
| A fine mist comes from the air outlet  | This occurs when the air in the room becomes very cold, for example in the "COOLING" or "DEHUMIDIFYING/DRY" modes.                      |
| A strange noise can be heard   | This noise is made by the expansion or contraction of the front panel due to variations in temperature and does not indicate a problem. |
| Insufficient airflow, either hot or cold   | Unsuitable temperature setting.   |
|  | Obstructed air conditioner intakes and outlets.   |
|  | Dirty air filter.   |
|  | Fan speed set at minimum.   |
|  | No refrigerant.   |
| The appliance does not respond to commands   | Remote control is not close enough to indoor unit.  |
|  | The batteries of remote control need to be replaced.  |
|  | Obstacles between remote control and signal receiver in indoor unit.  |
| The display is off   | Active DISPLAY function.  |
|  | Power failure.  |
| Switch off the air conditioner immediately and cut off the power supply in the event of: | Strange noises during operation.  |
|  | Faulty electronic control board.  |
|  | Faulty fuses or switches.   |
|  | Spraying water or objects inside the appliance.   |
|  | Overheated cables or plugs.   |
|  | Very strong smells coming from the appliance.   |

## TROUBLESHOOTING

### ERROR CODE ON THE DISPLAY

In case of error, the display on the indoor unit shown the following error codes:

| Display | Description of the trouble                 |
|---------|--|
| E1      | Indoor room temperature sensor fault       |
| E2      | Indoor pipe temperature sensor fault       |
| E3      | Outdoor pipe temperature sensor fault      |
| E4      | Refrigerant system leakage or fault        |
| E6      | Malfunction of indoor fan motor            |
| E7      | Outdoor ambient temperature sensor fault   |
| E0      | Indoor and outdoor communication fault     |
| E8      | Outdoor discharge temperature sensor fault |
| E9      | Outdoor IPM module fault                   |
| EA      | Outdoor current detect fault               |
| EE      | Outdoor PCB EEPROM fault                   |
| EF      | Outdoor fan motor fault                    |
| EH      | Outdoor suction temperature sensor fault   |

## DISPOSAL GUIDELINE (European)

This appliance contains refrigerant and other potentially hazardous materials. When disposing of this appliance, the law requires special collection and treatment. **DO NOT** dispose of this product as household waste or unsorted municipal waste.

When disposing of this appliance, you have the following options:

- Dispose of the appliance at designated municipal electronic waste collection facility.
- When buying a new appliance, the retailer will take back the old appliance free of charge.
- The manufacturer will also take back the old appliance free of charge.
- Sell the appliance to certified scrap metal dealers.
- Disposing of this appliance in the forest or other natural surroundings endangers your health and is bad for the environment. Hazardous substances may leak into the ground water and enter the food chain.

