

Top View

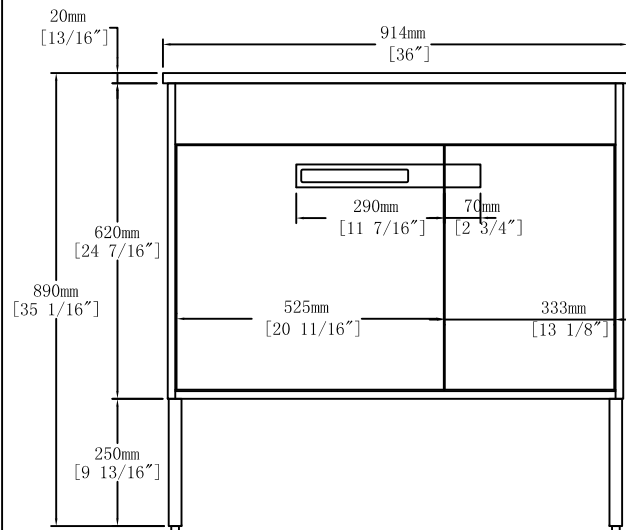

Front View

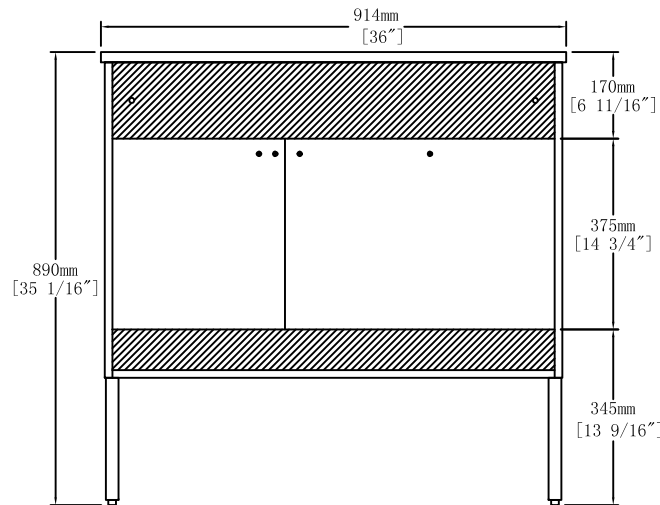

Back View

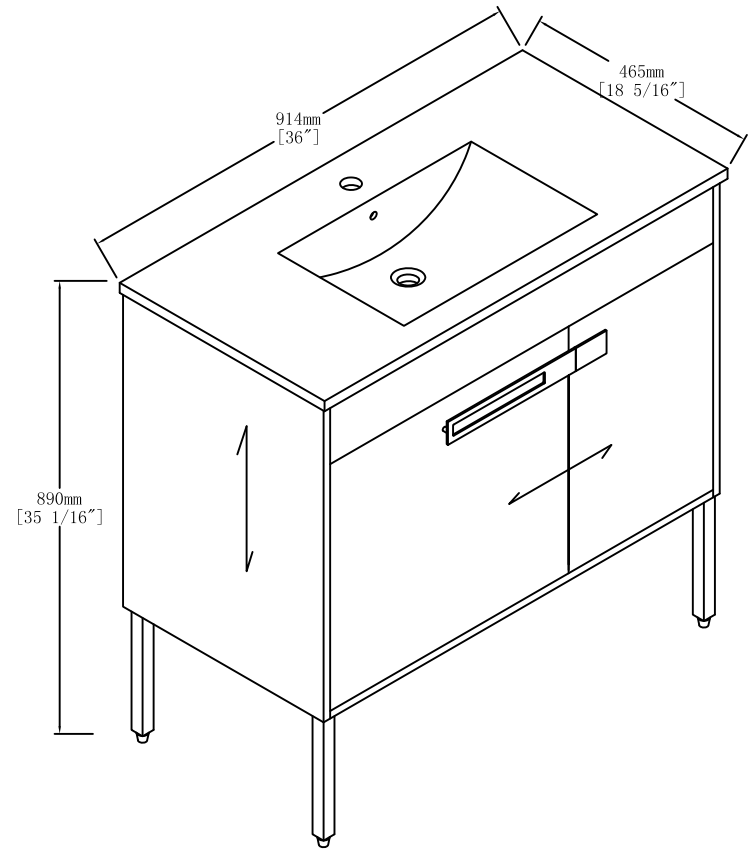

Item NO.

BV B00336

Version

V1

Projece

Date

2021-8-18