

VELUX®

PAC/PAD/PAH

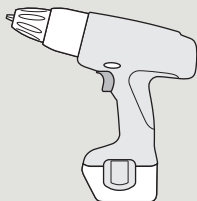

VAS 452184-2012-02

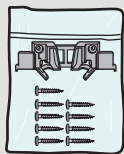
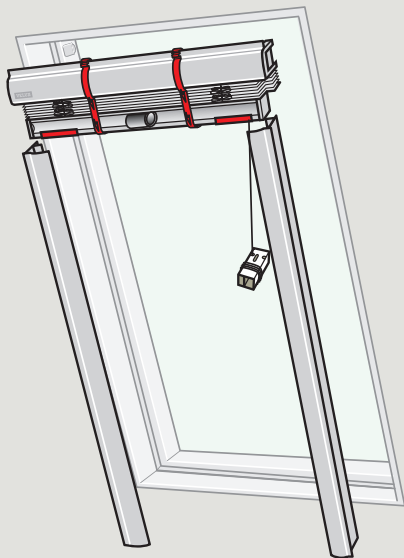

1

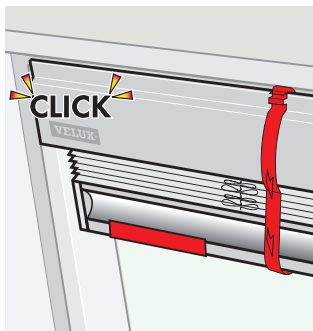
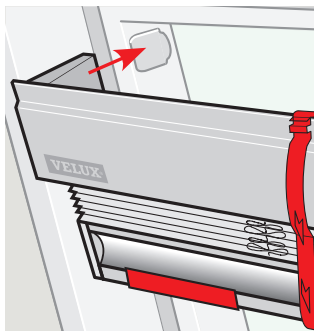
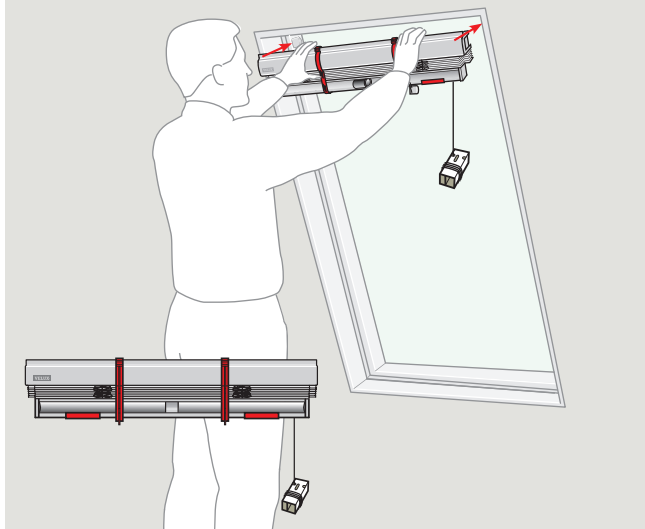

2

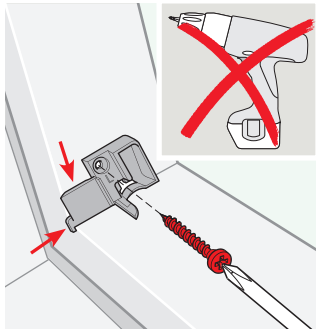
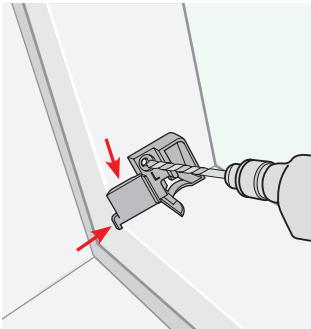
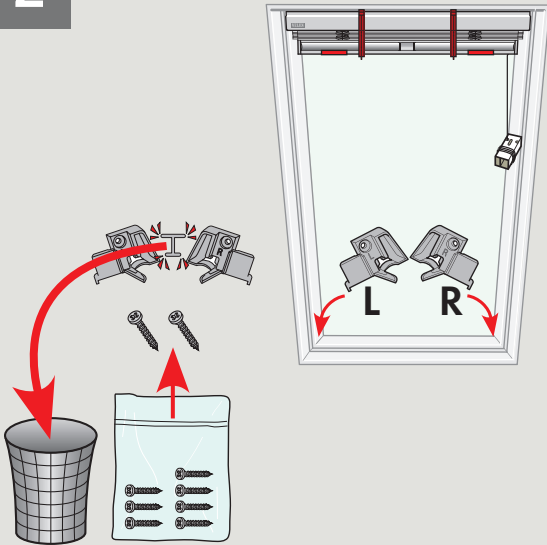

3

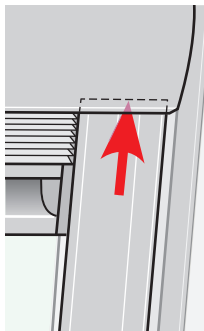
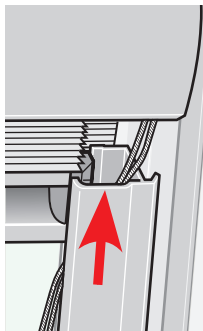
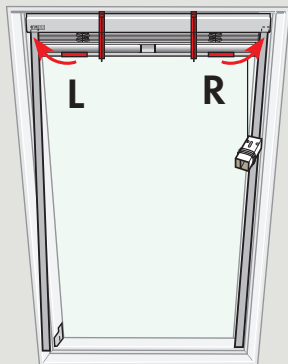
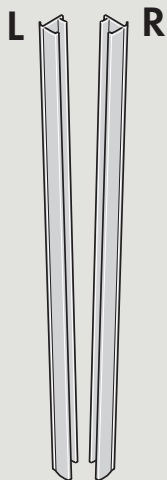

4

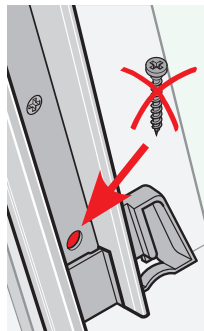
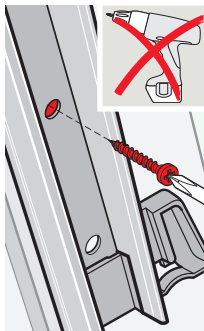
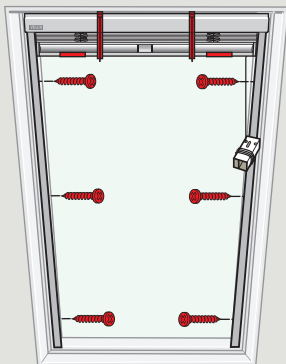
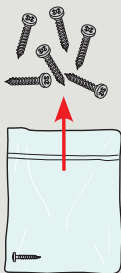

5

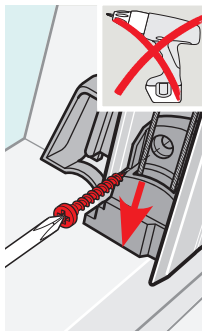
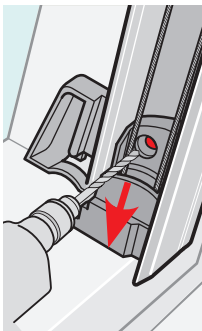
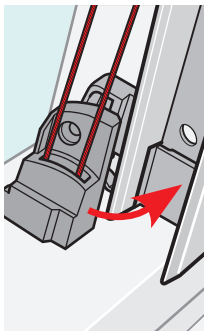
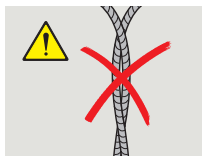
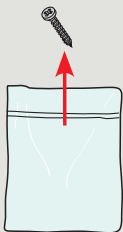
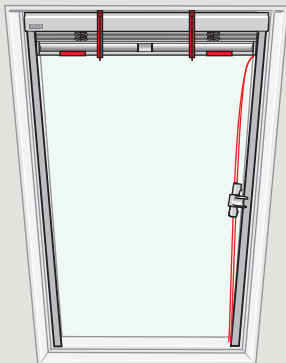



VELUX®

USA: VELUX America Inc.
1-800-88-VELUX

CDN: VELUX Canada Inc.
1 800 88-VELUX (888-3589)

AUS: VELUX Australia Pty. Ltd
1300 859 856

NZ: VELUX New Zealand Ltd.
09-6344 126

J: VELUX-Japan Ltd.
0570-00-8145

www.velux.com

6

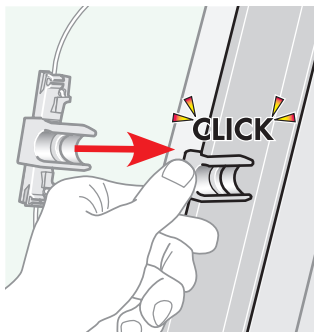
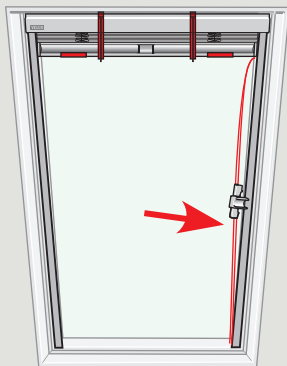

7

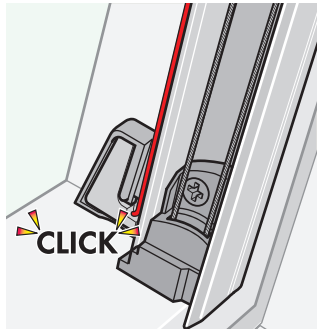
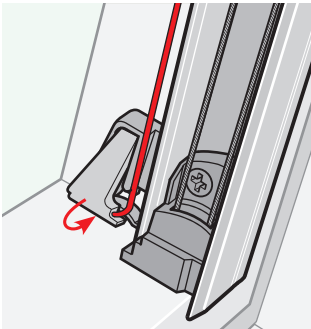
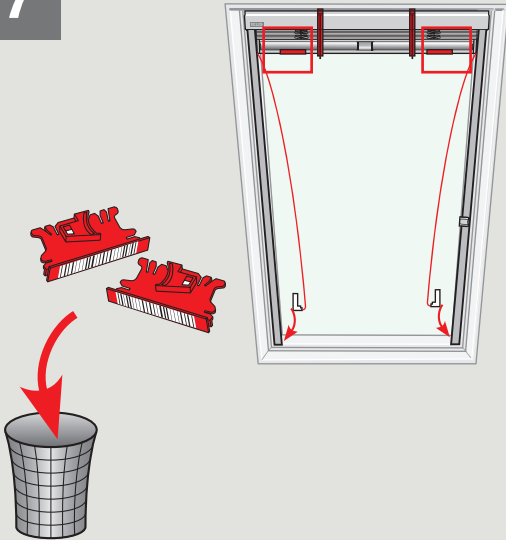

8

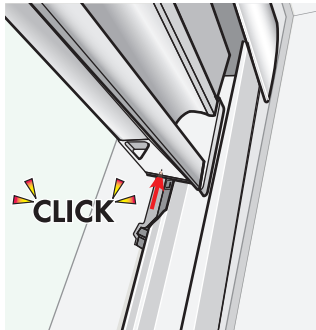
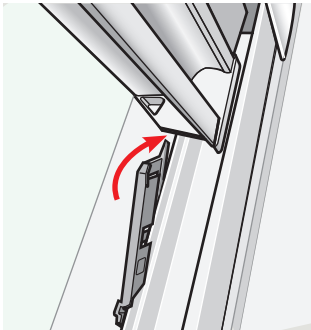
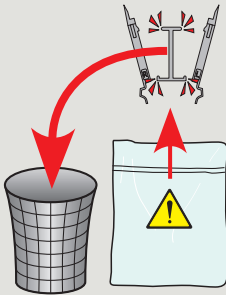
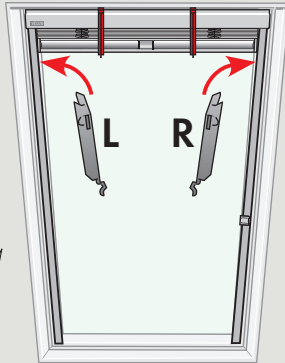

9

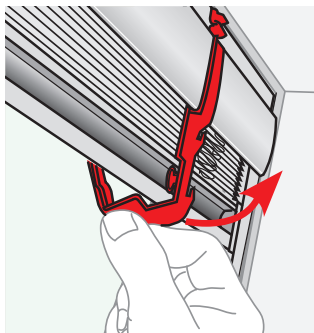

10

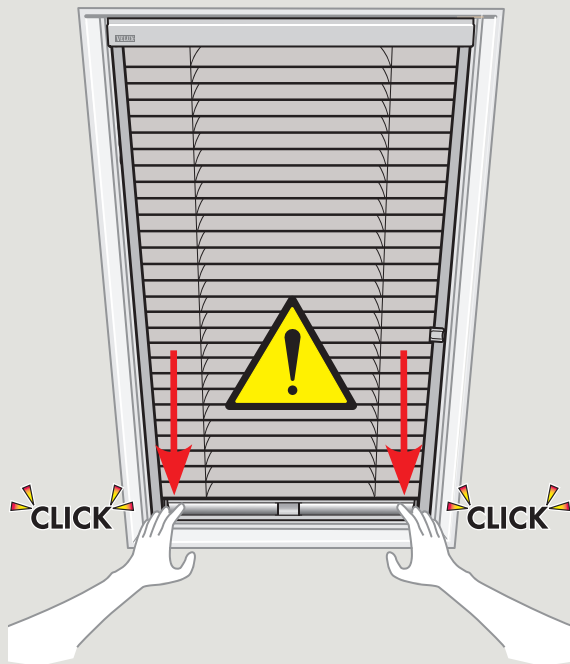

11

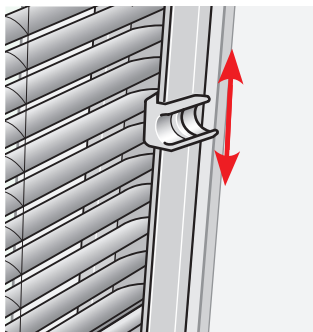
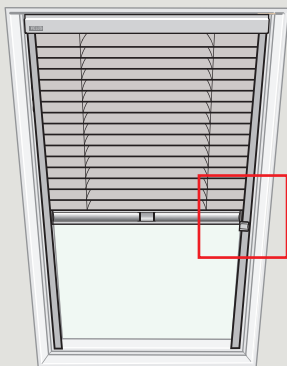



ZXT 200

