

LED MIRROR

With Front and Backlit

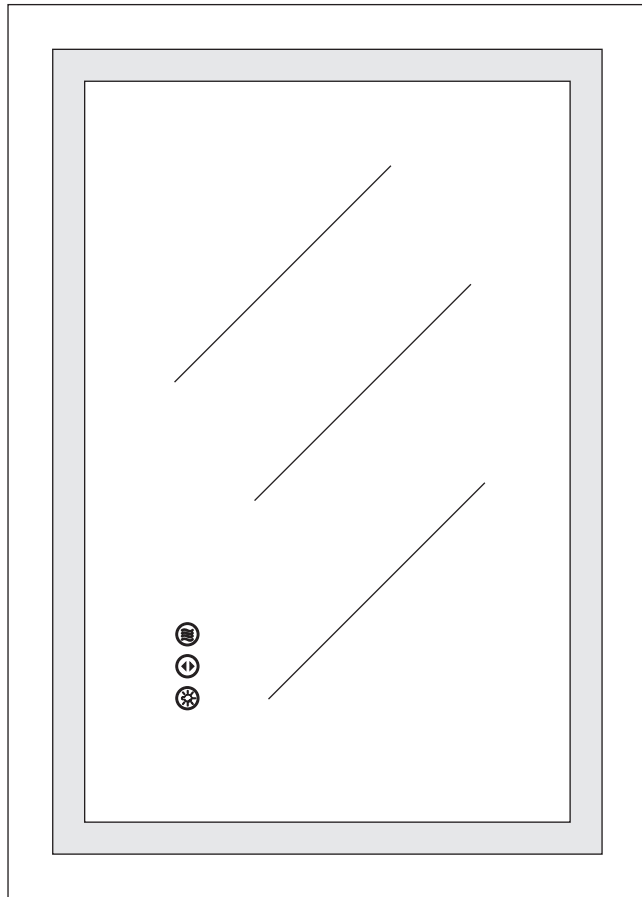

User Manual

Before Installation

Thank you so much for choosing Amorho mirrors, in order to facilitate the use of our products, please read this instruction carefully before you begin installation.

Please Notice:

1. Please read all instructions carefully before assembling the item.
2. After opening the package, inspect the product immediately upon receipt for transit damage or missing parts.
3. Please power the mirror with plug to test the all of functions of the mirror before wall mount.
4. Assembly by two or more adults is highly recommended.
5. Disconnect power before installing, adding or changing any components.
6. Ensure that the fixing location is able to take the weight of the complete fitting.
7. Keep the voltages 120V. If the voltage exceeds120V please use transformer.
8. To connect the wires to electrical junction box, a qualified technician or electrician is highly recommended.

DANGER - To reduce the risk of electric shock:

1. Always disconnect this furnishing from supply main before cleaning or servicing

For any problems, please feel free to contact us:

yujingus@163.com

Product Description

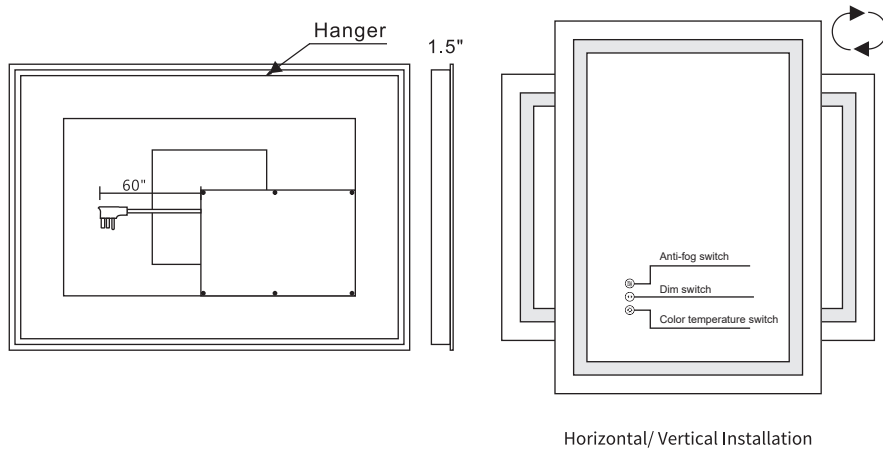

Horizontal/ Vertical Installation

Before installation, please check to make sure these functions work properly:



Anti-fog switch: After connecting the power, the anti-fog function is already turned on automatically. If you don't need to use it, just touch it to turn it off, to prevent wasting energy. The defogging will take effect within 10 minutes after it's turned on and close in 1 hour, so you can turn it on 10 minutes before taking a bath.



Dim switch: The led light supports 10% to 100% brightness adjustment, just long press the button. This button has memory function, the next time you open the mirror it will be in the same brightness it was in before it was last closed, which means that you don't have to touch the buttons each time.



Color temperature switch: The front and back lights all have three color temperatures that can be switched (3000K/4000K/6000K), just need to short press this button. And this button has a memory function as well.

Please note: To turn off the blue lights, press and hold the Defog button.

Product Information

Anti-fog	Memory	Certificate	Light Source	Cable Length	Material	Input Voltage	Warranty
Yes	Yes	ETL	LED	1.5M	Tempered Glass	120V~; 50/60Hz	3-year manufacturer



Specifications and Parameters

Model	Size	Thickness	Touch Button	LED Stripe Model	Color Temperature	Lumen	CRI	Power (W)	Input Voltage (V)	Weight (kg)
X-L001AC5070	20" X 28"	1.5"	3	2835 3 colors 192LED	3000/4000/6000	4164	90	48	120V~, 50/60Hz	6.9
X-L001AC6080	24" X 32"	1.5"	3	2835 3 colors 192LED	3000/4000/6000	5044	90	60	120V~, 50/60Hz	8.8
X-L001AC6090	24" X 36"	1.5"	3	2835 3 colors 192LED	3000/4000/6000	5484	90	60	120V~, 50/60Hz	9.68
X-L001AC7090	28" X 36"	1.5"	3	2835 3 colors 192LED	3000/4000/6000	6804	90	60	120V~, 50/60Hz	11
X-L001AC15070	28" X 60"	1.5"	3	2835 3 colors 192LED	3000/4000/6000	8564	90	100	120V~, 50/60Hz	16.8
X-L001AC10080	32" X 40"	1.5"	3	2835 3 colors 192LED	3000/4000/6000	7244	90	75	120V~, 50/60Hz	15.48
X-L001AC12080	32" X 48"	1.5"	3	2835 3 colors 192LED	3000/4000/6000	7684	90	100	120V~, 50/60Hz	15.4
X-L001AC18181	32" X 72"	1.5"	3	2835 3 colors 192LED	3000/4000/6000	10412	90	150	120V~, 50/60Hz	22.5
X-L001AC9080	36" X 32"	1.5"	3	2835 3 colors 192LED	3000/4000/6000	6364	90	75	120V~, 50/60Hz	12.09
X-L001AC9090	36" X 36"	1.5"	3	2835 3 colors 192LED	3000/4000/6000	6804	90	75	120V~, 50/60Hz	15.48
X-L001AC12191	36" X 48"	1.5"	3	2835 3 colors 192LED	3000/4000/6000	8212	90	100	120V~, 50/60Hz	17.2
X-L001AC9696	38" X 38"	1.5"	3	2835 3 colors 192LED	3000/4000/6000	7332	90	75	120V~, 50/60Hz	14.88
X-L001AC10075	40" X 30"	1.5"	3	2835 3 colors 192LED	3000/4000/6000	6628	90	75	120V~, 50/60Hz	12.63
X-L001AC10090	40" X 36"	1.5"	3	2835 3 colors 192LED	3000/4000/6000	7244	90	75	120V~, 50/60Hz	14.55
X-L001AC12075	48" X 30"	1.5"	3	2835 3 colors 192LED	3000/4000/6000	7508	90	75	120V~, 50/60Hz	16.84
X-L001AC120100	48" X 40"	1.5"	3	2835 3 colors 192LED	3000/4000/6000	8564	90	100	120V~, 50/60Hz	21.24
X-L001AC13975	55" X 30"	1.5"	3	2835 3 colors 192LED	3000/4000/6000	8300	90	100	120V~, 50/60Hz	19
X-L001AC13990	55" X 36"	1.5"	3	2835 3 colors 192LED	3000/4000/6000	8960	90	150	120V~, 50/60Hz	22.74
X-L001AC15075	60" X 30"	1.5"	3	2835 3 colors 192LED	3000/4000/6000	8916	90	150	120V~, 50/60Hz	19.84
X-L001AC15090	60" X 36"	1.5"	3	2835 3 colors 192LED	3000/4000/6000	9444	90	150	120V~, 50/60Hz	26.55
X-L001AC150100	60" X 40"	1.5"	3	2835 3 colors 192LED	3000/4000/6000	9884	90	150	120V~, 50/60Hz	28.97
X-L001AC18191	72" X 36"	1.5"	3	2835 3 colors 192LED	3000/4000/6000	10852	90	150	120V~, 50/60Hz	31.32
X-L001AC181100	72" X 40"	1.5"	3	2835 3 colors 192LED	3000/4000/6000	11248	90	150	120V~, 50/60Hz	34.32
X-L001AC21080	84" X 32"	1.5"	3	2835 3 colors 192LED	3000/4000/6000	11776	90	150	120V~, 50/60Hz	32.9
X-L001AC213100	84" X 40"	1.5"	3	2835 3 colors 192LED	3000/4000/6000	12656	90	150	120V~, 50/60Hz	41.13
X-L001AC24091	96" X 36"	1.5"	3	2835 3 colors 192LED	3000/4000/6000	13448	90	150	120V~, 50/60Hz	43
X-L001AC280100	110" X 40"	1.5"	3	2835 3 colors 192LED	3000/4000/6000	15604	90	150	120V~, 50/60Hz	55.12

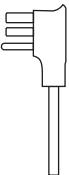
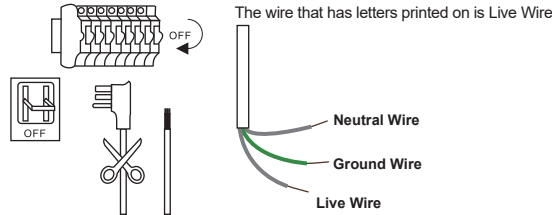
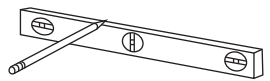
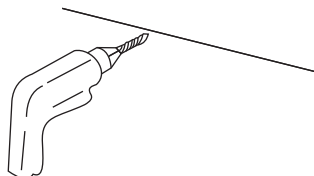
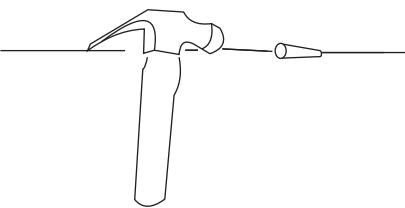
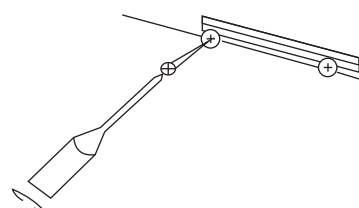
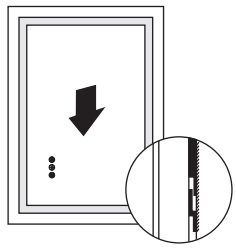
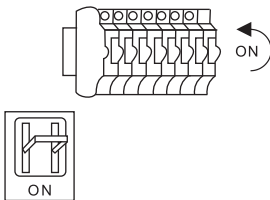



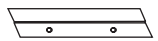
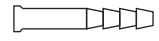

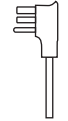
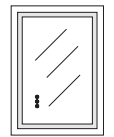
Installation Instruction

Method 1: Plug in	Method 2: Hardwire
 <p>Insert the plug into the socket, keep the voltages between 110V and 120V. If the voltage exceeds 120V, please use transformer.</p>	 <p>The wire that has letters printed on is Live Wire</p> <p>Neutral Wire</p> <p>Ground Wire</p> <p>Live Wire</p> <p>Cut the plug, connect the corresponding wire and tighten them (Disconnect power before hardwire).</p>
<p>Step 1</p>  <p>Draw a straight line with a ruler to keep the mirror horizontal</p>	<p>Step 2</p>  <p>Use a electric drill to punch four holes at the marked spots.</p>
<p>Step 3</p>  <p>Apply wall anchors with hammer.</p>	<p>Step 4</p>  <p>Use a screwdriver to screw the screws into the wall anchors.</p>
<p>Step 5</p>  <p>Hang the mirror on the wall</p>	<p>Step 6</p>  <p>Turn on the power.</p>

Package contents

				
Bracket x2	Wall Anchors x4	Screws x4	Plug	LED Mirror

You may need these tools

			
Level	Pencil	Hammer	Safety Goggles
			
Electric Drill	Screwdriver	Tape Measure	

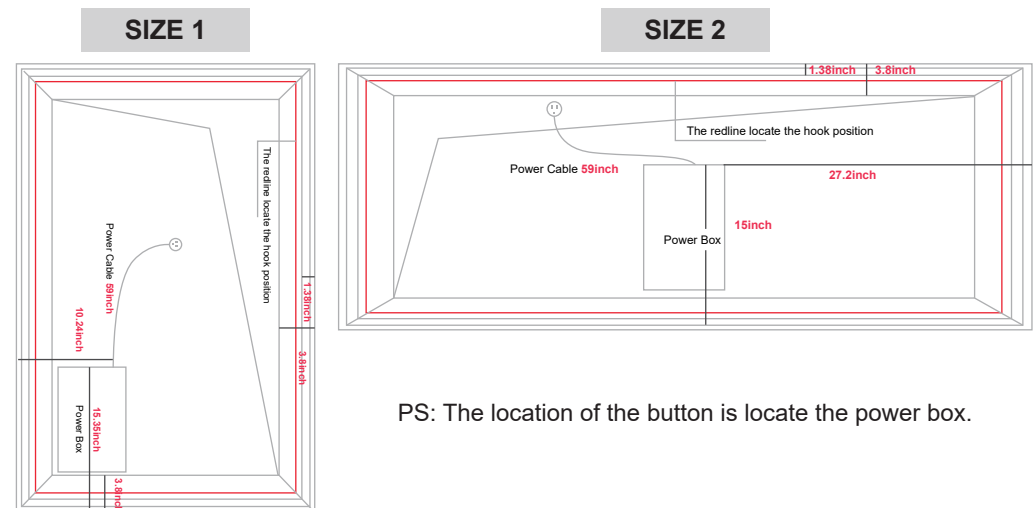

Meaning of LED Lights

State of LED Light	Meaning
White Light ON	Function is Working
Blue Light ON	Function Standby
Light OFF	Power OFF

Troubleshooting

LED doesn't turn on / Defogging doesn't work	Open the cover of the power supply on the back of the mirror to test the power cables, tighten the cables if they are loose. (Please cut off the power firstly before testing the power supply and cables)
Part of light strip is fault	Firstly, please pull the outer silicone strip away and press the inner light strip inward. If it still doesn't work, need replace the strip light.
After using for a few month, the light doesn't work.	Please contact us to replace the power supply.

AMORHO

Manufacturer: Zhongshan Chengjiang Glass Technology Co., Ltd.
 Address: Jichang Village, Dongfeng Town, Zhongshan City, Guangdong Province, China
 Contact us: yujingus@163.com

