











Assembly Instructions

Caution : You must read this before you proceed

Care & Maintenance

- ⊘  ● Not for commercial use. For residential use only.
- ✓  ● Furniture may scratch floors. We recommend using furniture pads to protect your floors.
- ⊘  ● Do not put hot items directly on furniture surface.
- ⊘  ● Do not clean furniture with harsh cleansers or polish.
- ⊘  ● Do not place furniture under direct sunlight.
- ⊘  ● Do not place furniture near heating or cooling vents.
- ⊘  ● Do not write on furniture without a padded barrier to protect the surface.
- ⊘  ● Do not place furniture outside . For indoor use only.
- ⊘  ● Stains may be removed with mild soap solution and damp cloth.
- ⊘  ● Children should not climb or jump on the furniture.
- ✓  ● Dust and pick-up spills using a clean, non-colored, lint-free cloth.





COFFEE TABLE

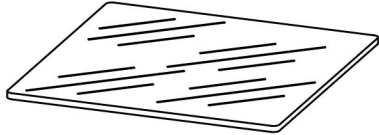
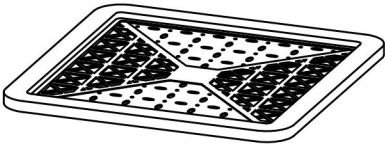
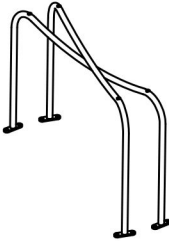





Parts List

Label	Picture	Description	QTY
A		Tempered Glass	1
B		Table Top	1
C		Leg Frame	1

Hardware

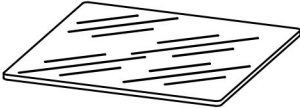
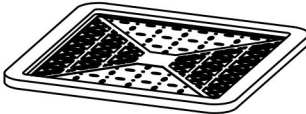
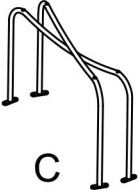
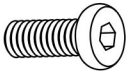
Label	Picture	Description	QTY
①		Short Bolt (M6x15mm)	9
②		Washer	9
③		Allen Wrench	1
④		Adjustable feet	5

Assembly Preparation

Before Beginning Assembly:			
	A	B	C
			
	①x9	②x9	③ x1
			
			④x5



- Read instructions, cover to cover-



- Have 2 adults on hand for assembly-



- Do not assemble on flooring or carpet-



- Assemble on a clean non-marring surface (packing foam)-



- Save all packaging until finished.

Assembly Steps

Overview:

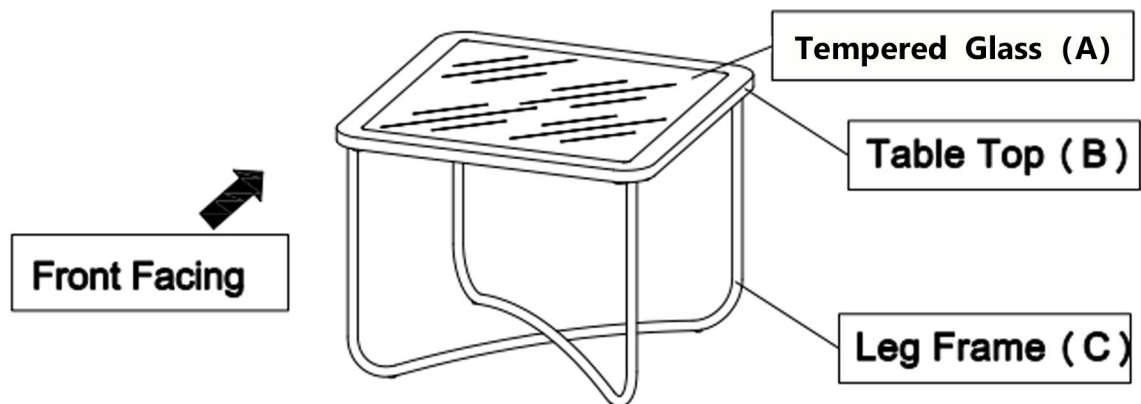

This Coffee Table has multiple parts and may require up to 30 minutes to assemble. To give you an overview of the Coffee Table parts, the above picture is to help you put the various parts into perspective. Please read through the instructions below to familiarise yourself with the parts and steps before assembly.

Step 1

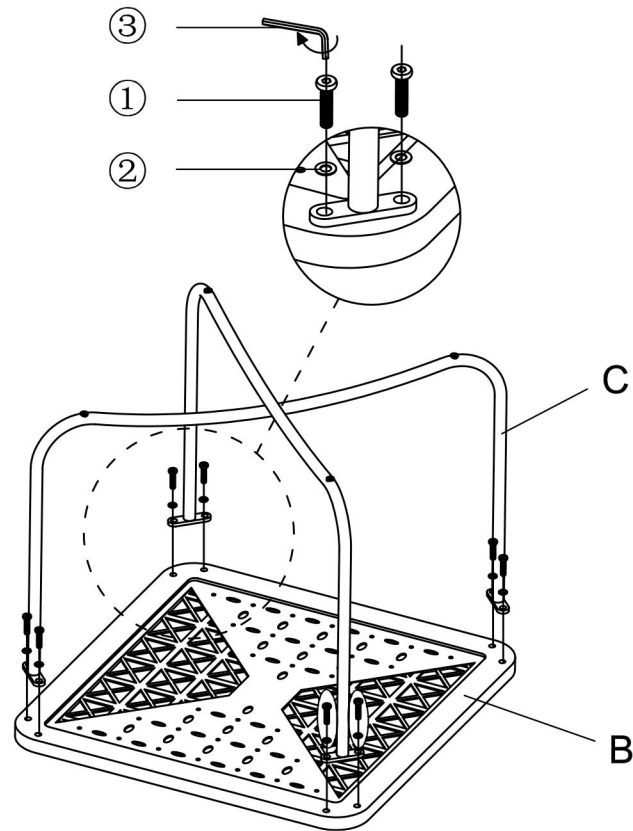

Carefully place the Table Top (B) facedown on a clean, non-marring surface with assistant from second adult. Align the mounting positions on assembled Leg Frame (C) and Table Top (B) with the mounting positions on Table Top (B), then attach them together by using Washers (2) with Allen Wrench (3).
Tightening all Bolts (1 & 2) completely in a sequential manner.

Step 2

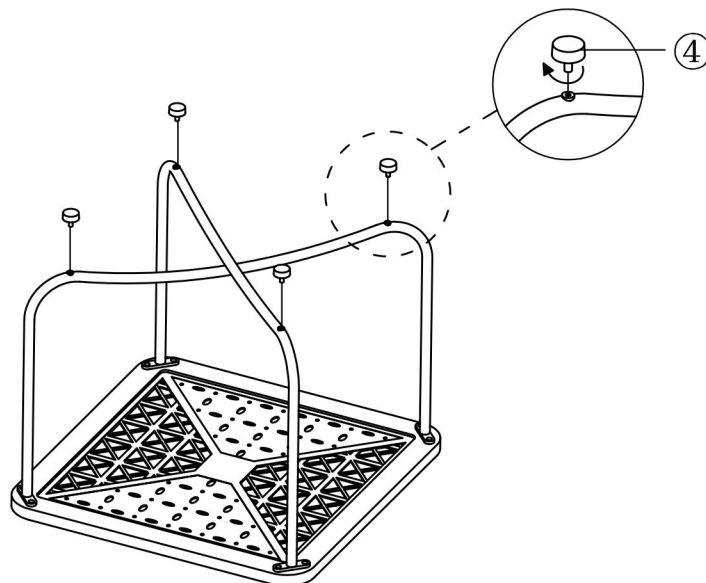

Install four adjustable feet (4) to the leg frame (C) in clockwise.

Step 3

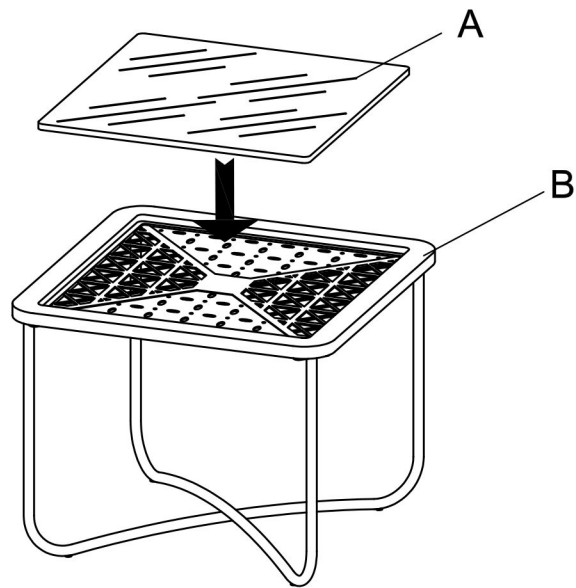

Carefully place the Tempered Glass(A) on the Table top(B) as shown in the picture.

Step 4

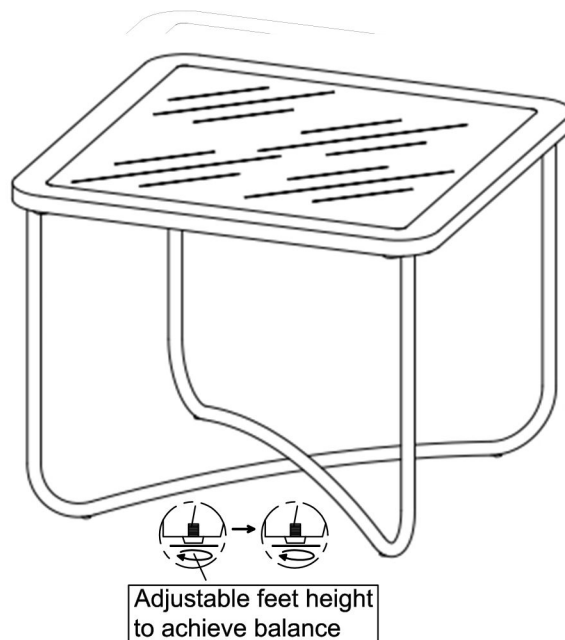

Stand the Table up.

Your Table is ready for use.

If the Table wobbles adjust the adjustable feet at the bottom of the Legs until the Table is level.

This Table can only be used on a flat, level surface.