

Window Air Conditioner MAW

USER MANUAL

MAW08V1QWT
MAW10V1QWT
MAW12V1QWT
MAW08V1QWT-T



Warning notices: Before using this product, please read this manual carefully and keep it for future reference. The design and specifications are subject to change without prior notice for product improvement. Consult with your dealer or manufacturer for details. The diagram above is just for reference. Please take the appearance of the actual product as the standard.

THANK YOU LETTER

Thank you for choosing Midea! Before using your new Midea product, please read this manual thoroughly to ensure that you know how to operate the features and functions that your new air conditioner offers in a safe way.

CONTENTS







THANK YOU LETTER	2
SAFETY INSTRUCTIONS	3
PRODUCT INSTALLATION	7
OPERATION INSTRUCTIONS	17
REMOTE CONTROL AND APP INSTRUCTIONS	22
CLEANING AND MAINTENANCE	36
TROUBLESHOOTING TIPS	37
WARRANTY	39
TRADEMARKS, COPYRIGHTS AND LEGAL STATEMENT	40
DATA PROTECTION NOTICE	41

SAFETY INSTRUCTIONS

Intended Use

The following safety guidelines are intended to prevent unforeseen risks or damage from unsafe or incorrect operation of the appliance. Please check the packaging and appliance on arrival to make sure everything is intact to ensure safe operation. If you find any damage, please contact the retailer or dealer. Please note modifications or alterations to the appliance are not allowed for your safety concern. Unintended use may cause hazards and loss of warranty claims.

Explanation of symbols

	Warning This symbol shows that this appliance used a flammable refrigerant. If the refrigerant is leaked and exposed to an external ignition source, there is a risk of fire.
	Caution This symbol shows that the operation manual should be read carefully.
	Caution This symbol shows that a service personnel should be handling this equipment with reference to the installation manual.
	Caution This symbol shows that information is available such as the operating manual or installation manual.
	Warning The signal word indicates a hazard with a medium level of risk which, if not avoided, may result in death or serious injury.
	Caution The signal word indicates a hazard with a low degree of risk which, if not avoided, may result in minor or moderate injury.
	Attention The signal word indicates important information (e.g. damage to property), but not danger.

Read these operating instructions carefully and attentively before using/commissioning the unit and keep them in the immediate vicinity of the installation site or unit for later use!

CAUTION

- For support, please call the Service Center at 1-866-646-4332.
- This appliance is not intended for use by people (including children) with reduced physical, sensory, or mental capabilities or lack of experience and knowledge, unless they have been given supervision or instruction concerning use of the appliance by a person responsible for their safety.
- Children should be supervised to ensure that they do not play with the appliance.
- The appliance shall be installed in accordance with national wiring regulations.
- Do not operate your air conditioner in a humid room such as a bathroom or laundry room.

WARNING

- Be sure the air conditioner has been securely and correctly installed according to the installation instructions in this manual. Save this manual for possible future use in removing or installing this unit.
- Plug in power cord plug properly.
Otherwise, it may cause electric shock or fire due to excess heat generation.
- Do not modify power cord length or share the outlet with other appliances as it may cause electric shock or fire due to overheating.
- Always ensure effective grounding.
Incorrect grounding may cause electric shock.
- Unplug the unit if you notice unusual sounds or smells or smoke coming from it.
A damaged product may cause fire and electric shock.
- Ventilate room before operating the air conditioner if there is a gas leakage from another appliance.
- Do not operate or stop the unit by inserting or pulling out the power cord plug.
- Do not operate with wet hands or in very humid environments.
It may cause electric shock.
- Do not allow water to come into contact with any electric parts.
It may cause failure or electric shock.
- Do not use the socket if it is loose or damaged.
It may cause fire and electric shock.
- Do not use or keep the power cord close to heating appliances.
It may cause fire and electric shock.
- Do not use any devices or materials for installation that are not recommended in this manual.
- Do not disassemble or modify unit.
It may cause failure and electric shock.
- Do not damage or use an alternate power cord.
It may cause fire and electric shock.
If the power cord is damaged, it must be replaced by the manufacturer or an authorized service center or a similarly qualified person in order to avoid a hazard.
- Do not direct air flow straight into persons to avoid possible health hazard.
- Do not open the unit during operation.
It may cause electric shock.
- Do not use the power cord near flammable gas or combustibles, such as gasoline, benzene, thinner, etc.
It may cause an explosion or fire.
- Do not let children hang on the air conditioner or bracket.
A serious injury may occur.
- Avoid fire hazard or electric shock. Do not use an extension cord or an adaptor plug. Do not remove any prongs from the power cord.
- Be sure the air conditioner is properly grounded. To minimize shock and fire hazards, proper grounding is important. The power cord is equipped with a three-prong grounding plug for protection against shock hazards.
- Your air conditioner must be used in a properly grounded wall receptacle. If the wall receptacle you intend to use is not adequately grounded or protected by a time delay fuse or circuit breaker, have a qualified electrician install the proper receptacle. Ensure the receptacle is accessible after the unit installation.
- Be sure the electrical service is adequate for the model you have chosen. This information can be found on the serial plate, which is located on the side of the cabinet and behind the grille.
- Do not drink the drain water. It may contain mold and bacteria that can lead to death if ingested.



CAUTION

- When the air filter is to be removed, do not touch the metal parts of the unit. It may cause injury.
- When the unit needs cleaning, switch off, and turn off the circuit breaker. Do not clean unit when power is on as it may cause fire, electric shock or injury.
- Do not place obstacles around air inlets or inside of air outlet. It may cause failure or accident.
- Clean with a soft cloth only. Do not use strong detergents that contain wax or thinners as it may damage the product.
- Use caution when unpacking and installing. Sharp edges could cause injury.
- Do not clean the air conditioner with water. Water may enter the unit and degrade the insulation which could lead to electric shock.
- Do not put a pet or house plant where it will be exposed to direct air flow. This could injure the pet or harm the plant.
- Hold the plug by the head of the power plug when taking it out. Otherwise, it may cause electric shock and damage.
- Ensure that the installation is properly secured to prevent the product from potentially falling.
- Do not place heavy objects on the power cord and ensure that the cord is not compressed. Otherwise, there is danger of fire or electric shock.
- If water is spilled on the unit, turn off the unit and switch off the circuit breaker. Isolate supply by taking the power-plug out and contact a qualified service technician.
- Do not use near gas stove or other gas burning appliances, as air flow may affect gas combustion.
- Do not use for any purpose other than room comfort. Do not use this air conditioner to preserve precision devices, food, pets, plants, and art objects. It may cause deterioration.
- Turn off the main power switch if the unit is not to be used for an extended time.
- Always insert the filters securely. Clean filter once every two weeks. Operation without filters may cause failure.



WARNING

- Do not try to accelerate the defrosting process or methods of cleaning that are not recommended by the manufacturer.
- The appliance shall be stored in a room without a continuously operating ignition source (for example, open flames or an operating gas appliance) or an ignition source (for example, an operating electric heater) close to the appliance. The appliance shall also be stored in a room without ignition sources.
- Do not pierce or burn.
- Be aware that the refrigerants may not contain an odor.
- Keep ventilation openings clear of obstruction.
- Unit is only to be serviced by a Midea authorized servicer, please call Customer Service at 1-866-646-4332 for support.
- Flammable refrigerant R32 is used within air conditioner. Please follow the instructions carefully to handle, install, clean, and service the air conditioner to avoid damage or hazard. Do not dispose of air conditioner in regular trash. Contact qualified agency for proper disposal.
- No open fire or devices that generate spark/arcing shall be around the air conditioner to avoid causing ignition of the flammable refrigerant used. Please follow the instructions carefully to store or maintain the air conditioner to prevent mechanical damage from occurring.

Operation of Current Device

The power supply cord contains a current measuring device that detects damage to the power cord. Test your power supply cord as follows:

1. Plug in the air conditioner.
2. The power supply cord will have TWO buttons on the plug head. Press the TEST button. You will notice a click as the RESET button pops out.
3. Press the RESET Button. You will notice a click as the button engages.
4. The power supply cord is now supplying electricity to the unit. (On some products this is also indicated by a light on the plug head.)

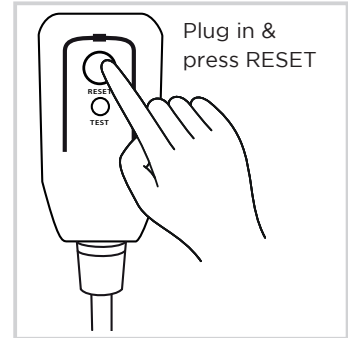

NOTE

The power supply cord with this air conditioner contains a current detection device designed to reduce the risk of fire.

In the event that the power supply cord is damaged, it can not be repaired. It must be replaced with a cord from the manufacturer.

NOTE

- Do not use this device to turn the unit on or off.
- Always make sure the RESET button is pushed in for correct operation.
- The power supply cord must be replaced if it fails to reset when either the TEST button is pushed, or it can not be reset. Please contact Customer Service.

Grounding type wall receptacle

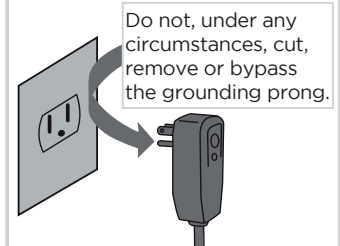

Power supply cord with 3-prong grounding plug and current detection device.

Explanation of symbols displayed on the unit

	WARNING	This symbol shows that this appliance used a flammable refrigerant. If the refrigerant is leaked and exposed to an external ignition source, there is a risk of fire.
	CAUTION	This symbol shows that the operation manual should be read carefully.
	CAUTION	This symbol shows that a service personnel should be handling this equipment with reference to the installation manual.
	CAUTION	This symbol shows that information is available such as the operating manual or installation manual.



Caution: Risk of fire/flammable materials
(Required for R32/R290 units only)

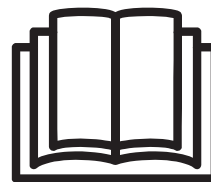

IMPORTANT NOTE: Read this manual carefully before installing or operating your new air conditioning unit. Make sure to save this manual for future reference.

PRODUCT INSTALLATION

Installation Video

Scan the QR code with your mobile device to watch an installation video of the Midea U.



⚠ WARNING - Before You Begin

Read these instructions completely and carefully.

- **IMPORTANT** - Save these instructions.
- **IMPORTANT** - Observe all governing codes and ordinances.

We recommend that two people install this product.

Proper installation is the responsibility of the installer.

Product failure due to improper installation is not covered under the Limited Warranty.

You **MUST** use all supplied parts and use proper installation procedures as described in these instructions when installing this air conditioner.

Do not, under any circumstances, cut or remove the third (ground) prong from the power cord.

Do not change the plug on the power cord of the air conditioner.

Aluminum house wiring may present special problems - consult a qualified electrician.

When handling the air conditioner, be careful to avoid cuts from sharp metal edges and aluminum fins on front and rear coils. Please wear cut-resistant gloves.

Bracket should only be used for its intended purpose. If not, the warranty will be voided.

Window Requirements

Your air conditioner is designed to install in standard double hung windows with opening widths of 22 to 36 inches (558mm to 914mm) and a window height of 13.75" (349mm).

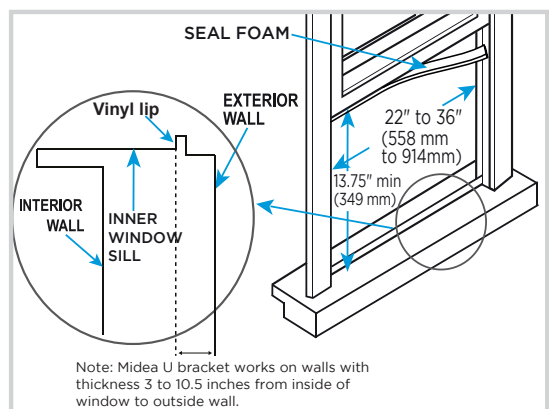

Tools You Will Need

Phillips Screwdriver

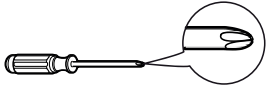

Level



Flathead Screwdriver



Pencil

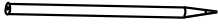

Ruler or tape measure



Scissors or knife





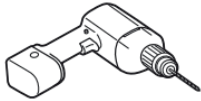



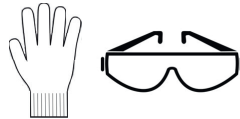









Drill and 1/8" drill bit



Proper PPE



Installation Hardware

	1" Type A Screw	2*		Open Window Bracket - RH	1
	1/2" Type A Screw	3*		Open Window Bracket - LH	1
	1/2" Type B Screw	2*		Window Sash Lock	1
	1/4" Type B Screw	2*		Window Sash Foam	1
	Main Bracket	1		Window Sealing Foam	1
	Right Extension Arm (For 26"-36" windows)	1		Bracket Sealing Foam	1
	Right Extension Arm - Short (For 22"-26" windows)	1		Additional Side Arm Foam	2
	Main Support Pin	2*		Side Arm Foam	2
	Cotter Pin	2*	<i>* Denotes extra hardware provided in separate bag.</i>		

NOTE

Save carton and these Installation Instructions for future reference. The carton is the best way to store unit during winter, or when not in use. If any piece of hardware is missing, DO NOT INSTALL THE PRODUCT, and call customer service at 1-866-646-4332.

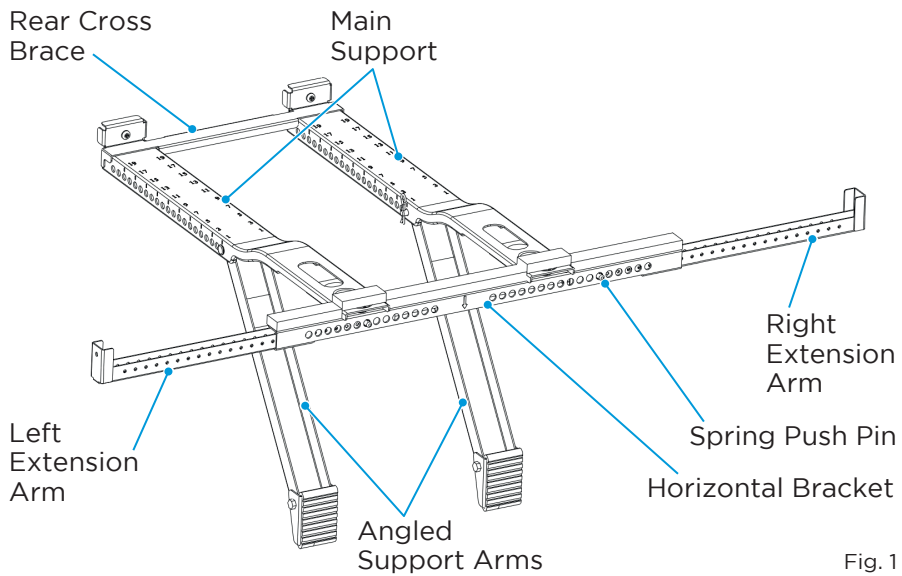
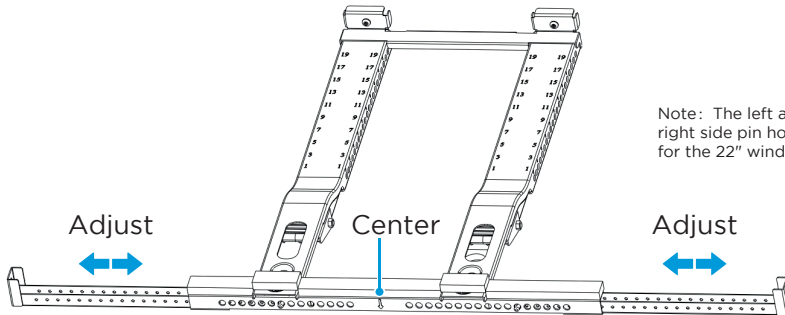

Fig. 1

1. Prepare the Bracket - Install Video Time 1:48

Remove the top foam insert containing the bracket and hardware from the carton.



Note: The left arm moving to the right side pin holes when adjusting for the 22" windows.

Fig. 2

- A. Measure the inside opening of your window sill and use that distance to set the total width of the bracket Extension Arms. To adjust the extension arms, press the Spring Push Pin, slide the Left Extension Arm out and then install the Right Extension Arm. Use the short arm for 22-26" windows, and the long arm for 26-36" windows.
- B. Apply Bracket Sealing Foam strips to the bottom of the bracket as shown. Repeat on both sides.

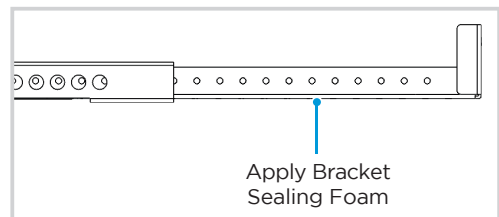

Fig. 3

2. Prepare the Window - Install Video Time 1:58

Lower sash must open sufficiently to allow a clear vertical opening of 13.75 inches. Side louvers and the rear of the AC must have clear air space to allow enough airflow through the condenser for heat removal. The rear of the unit must be outdoors, not inside a building or garage. Find the center of your window and lightly mark with a pencil.

3. Install Support Bracket - Install Video Time 3:12

- A. Install the Main Support Bracket into the window opening. Ensure that the Horizontal Bracket and Extension Arms are located on the indoor side of the window.

WARNING

Maintain control of the bracket until installation is complete.

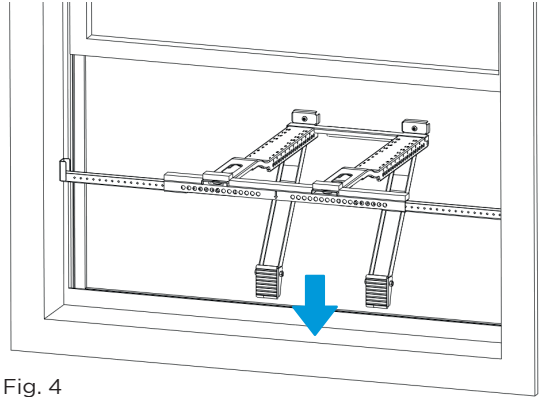

Fig. 4

- B. Move the Angled Support Arms toward the exterior wall until the feet touch the wall. Place the level on the bracket and adjust the Support Arms so that it is level or tilted 1/4 bubble downward and towards the outside. If exactly 1/4 bubble cannot be achieved, set the angled support arms to the closest setting so that a slight outward tilt exists.

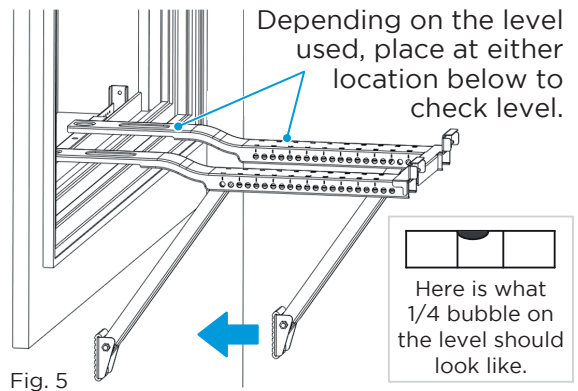

Fig. 5

- C. Insert the Main Support Pin through the holes in the Main Support and Angled Support Arm. Match the hole numbers on both Main Supports for alignment.

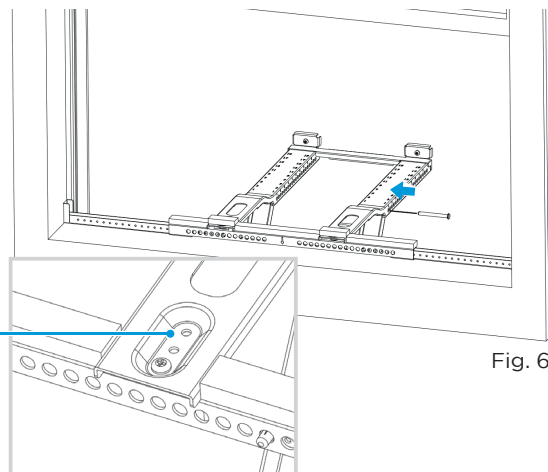

Fig. 6

If further adjustment is needed, use alternate holes where the Main Supports attach to the Horizontal Bracket

D. Check the level again and ensure the bracket feels secure. After making any necessary adjustments, insert the cotter pins into the Main Support Pins.

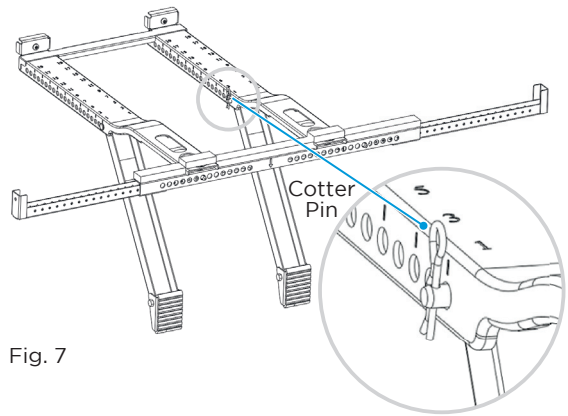

Fig. 7

Secure the bracket to the windowsill by drilling 1/8" pilot holes and installing the 1/2" Type A screws as shown in Fig. 9.

If your window has a lip, make sure the bracket is placed as shown in Fig. 8.

If your window does not have a lipped sill, be sure to drill 1/8" pilot holes and install the 1" Type A (Flat Sill) screws as shown in Fig. 9 below.

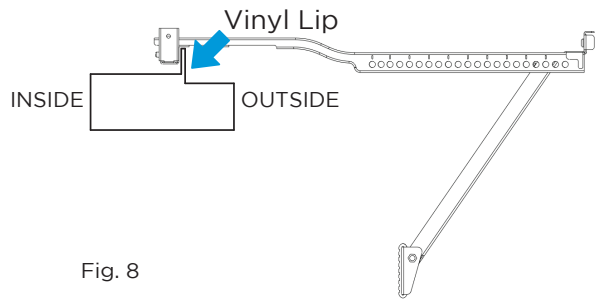

Fig. 8

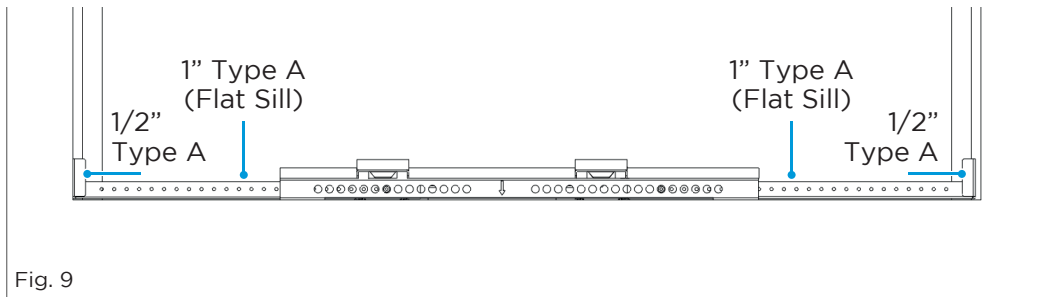

Fig. 9

E. If necessary, cover the holes on the front of the bracket with the Bracket Sealing Foam.

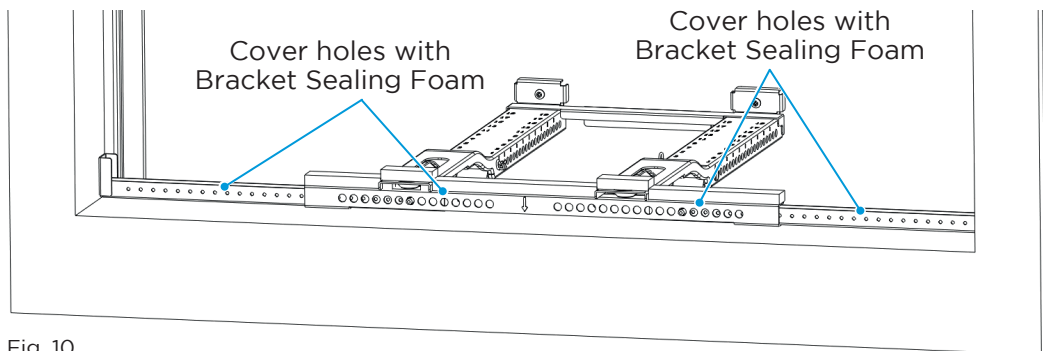

Fig. 10

4. Install Air Conditioner - Install Video Time 4:36

- A. Set the air conditioner on top of the support bracket. Ensure the grooves on the bottom of the air conditioner align with the Main Supports. Using a level, check for proper tilt towards the outside.

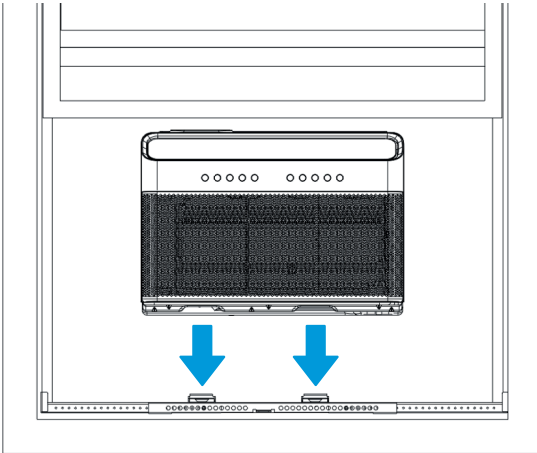

Fig. 12

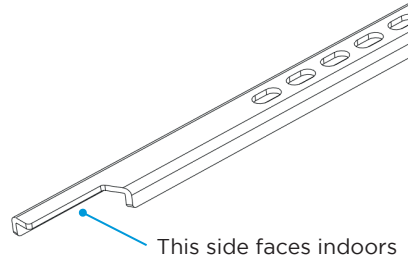

Fig. 11

WARNING

Do not leave the unit unattended during installation.

- B. Pull the window down into the slot to help align the unit in the correct location. Keep the window partially inserted into the slot to maintain alignment during installation. Fold down both Side Arm Hinges.

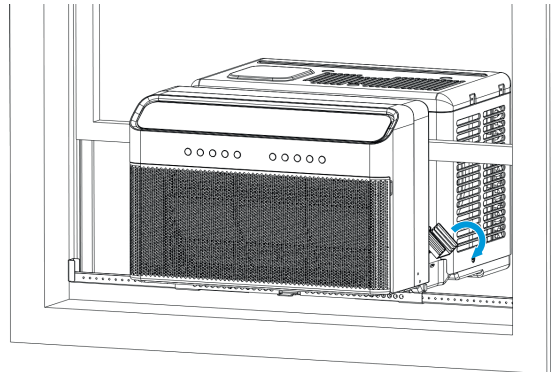

Fig. 13

- C. Next, you must install the Open Window Brackets using the provided screws as shown.

WARNING

Open window brackets are for fixing units and brackets. Failing to install the Open Window Brackets could cause injury or property damage.

Use the 1/2" Type B screw.

Use the 1/4" Type B screw.

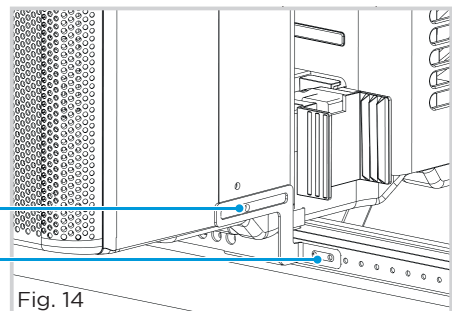

Fig. 14

5. Foam Installation - Install Video Time 5:33

- A. Measure the distance between the Side Arm Hinge and the closest part of the window frame in line with the Side Arm. Add 1/4" to this distance and cut the Side Arm Foam to length.

WARNING

Do not leave the unit unattended during installation.

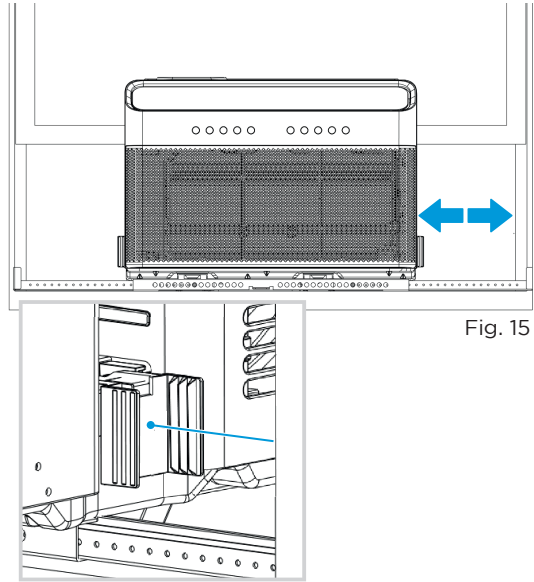

- B. Apply Window Sealing Foam to the Side Arm Foam as shown. Note that the Window Sealing Foam attaches to the side next to the air conditioner. If your window does not have a lipped sill, apply the Additional Side Arm Foam as shown with the dotted line.

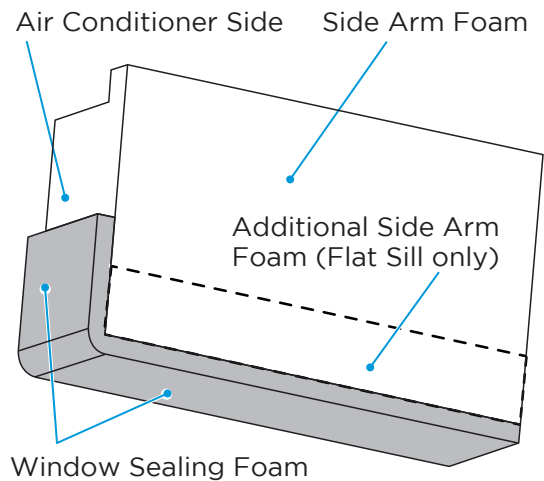
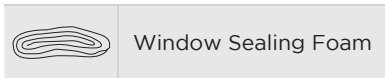

Fig. 16

- C. Insert Side Arm Foam into Side Arm Hinge until the top front of the Side Arm is flush with the top of the hinge.

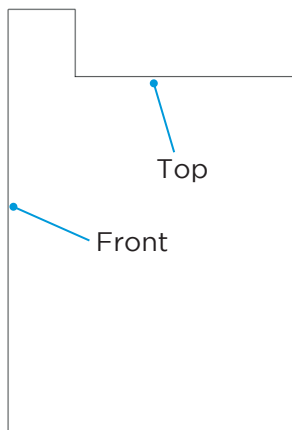

Fig. 18

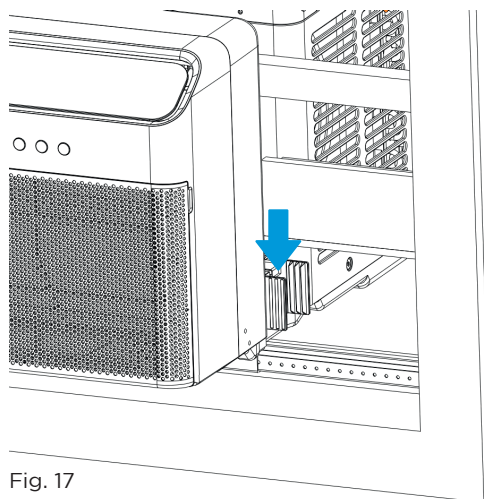

Fig. 17

NOTE

Repeat the side arm foam installation steps on the other side of the unit as well.

- D. The Anti-Tip Brackets (located in the U channel) must be extended into the window track opening (vertical track your window slides up and down in) until they stop. Secure the brackets in place by reusing the screw you just removed.

WARNING

You must extend the Anti-Tip Brackets into the Window Track Opening. Failure to follow this warning may cause serious injury.

Top view

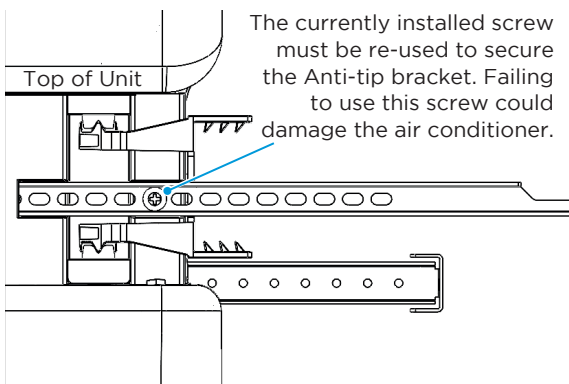

Fig. 19

The image shows how the Anti-Tip Bracket is to be installed in the window track. Note the Side Arm Foam was removed for illustration purposes only.

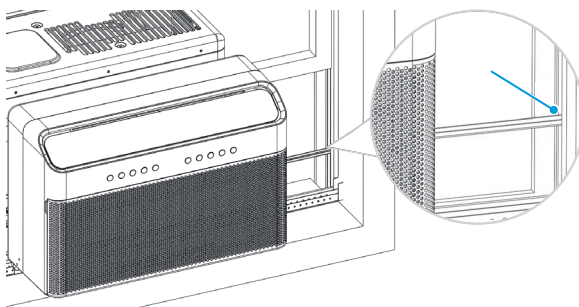

Fig. 20

- E. Install a strip of Window Sealing Foam to the bottom of your lower sash sealing any small gaps between the window and air conditioner. Then close the window and check for gaps. Fill any gaps with the included foam as needed.
- F. Extend the Integrated Window Locks (located in the U channel) until they contact the window.

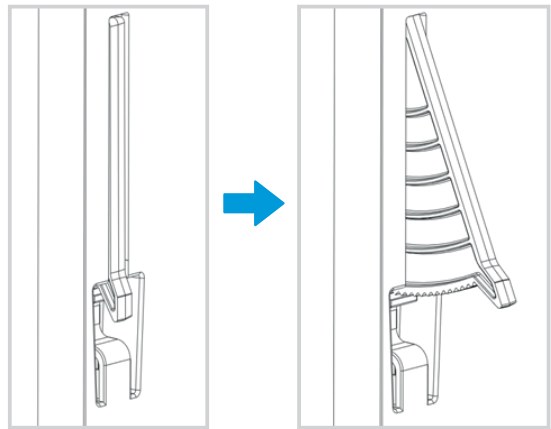

Fig. 21

- G. (Optional) To secure the lower sash in place, attach the Window Sash Lock with 1/2" Type A screws as shown.

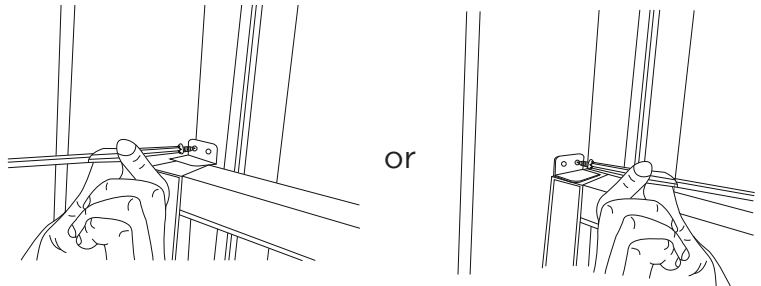
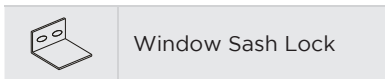

Fig. 22

- H. Cut window sash foam and insert it in the space between the upper and lower sashes.

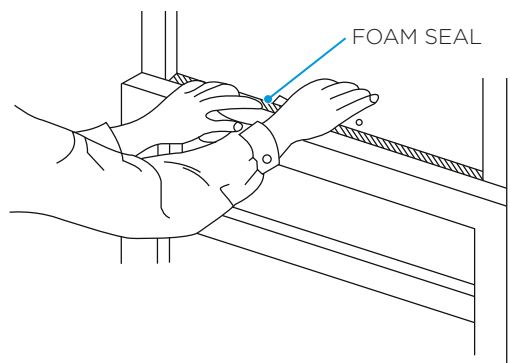
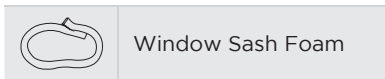

Fig. 23

Final Check: Review the installation and check for any gaps or openings to the outdoor air. Cover these gaps with the provided foam ensuring no outdoor air leaks inside. See image for areas to check for gaps.

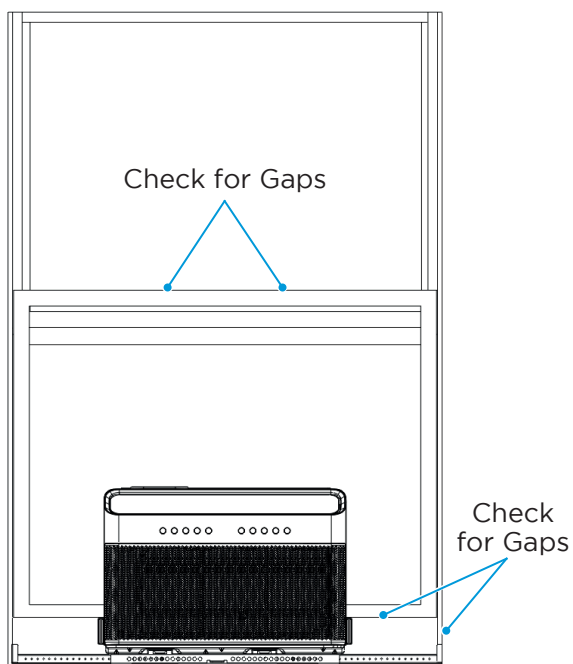

Fig. 24

IF AC IS BLOCKED BY STORM WINDOW

Add wood as shown, or remove storm window before air conditioner is installed.

If storm window frame must remain, be sure the drain holes or slots are not caulked or painted shut. Accumulated rain water or condensation must be allowed to drain out.

You must secure the support bracket to the added wood piece using the provided 1" Type A Screws. Refer to the Open Window Bracket installation step.

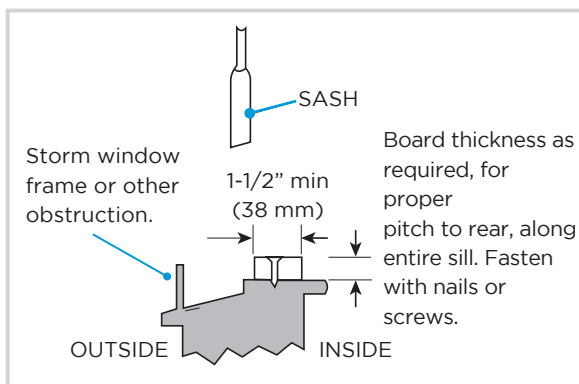

Fig. 25

OPERATION INSTRUCTIONS

Normal Sounds

High Pitched Chatter

High efficiency compressors may have a high pitched sound during cooling cycle.

Trickling Sound

Droplets of water hitting condenser during normal operation may cause a trickling sound.

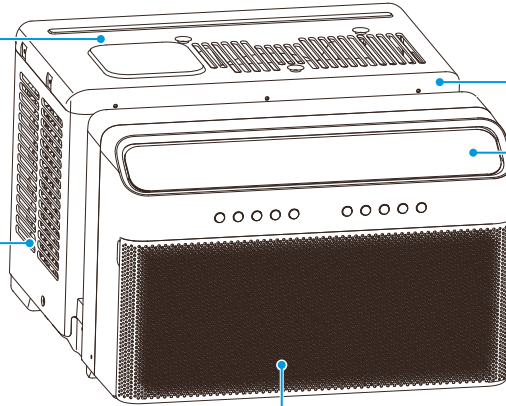

Vibration

Unit may vibrate and make noise because of poor wall or window construction or incorrect installation.

Sound of Rushing Air

In front of the unit, you may hear the sound of rushing air being moved by the fan.

Gurgle/Hiss

Gurgling or hissing noises may be heard due to refrigerant flowing through evaporator during normal operation.

Sound Performance

The following table shows the sound performance data for these window air conditioners. Please use your specific model number to reference the correct sound power number in the table.

Model Number	Sound Power, dB(A)*
MAW08V1QWT/MAW08V1QWT-T	42
MAW10V1QWT	42
MAW12V1QWT	42

* per ISO 3744 at low fan speed

NOTE

All the illustrations in this manual are for explanation purpose only. The actual installation may vary.

Air Conditioner Operation

WARNING

To reduce the risk of fire, electrical shock, or injury to people or property, read the SAFETY PRECAUTIONS before operating this appliance.

Cooling Operation	Outdoor temp.: 64°F ~ 109°F / 18°C ~ 43°C
	Indoor temp.: 60°F ~ 90°F / 16°C ~ 32°C

NOTE

- The relative humidity of the room should be less than 80%. If the unit is used in a condition with a relative humidity over 80%, there will be condensed water on the surface of the unit.
- Performance may be reduced outside of these operating temperatures.

NOTE

Always wait 3 minutes when turning the unit off and then on again, or when changing from cool to fan and back to cool. This prevents damage from occurring to the compressor.

To begin operating the air conditioner, follow these steps:

1. Plug in the air conditioner (be sure to follow the power cord instructions).
2. Turn the power on to the air conditioner, using the ON/OFF button.
3. Set the thermostat to the coldest temperature setting.
4. Select the Cool mode setting.
5. Adjust the louver for comfortable air flow (see Air Directional Louvers).
6. Once the room has cooled, adjust the thermostat to the setting you find most comfortable.
7. Make sure the air flow inside and outside is not obstructed by anything.

Air Directional Louvers

The louvers will allow you to direct the air flow up or down and left or right throughout the room as needed. Use the SWING button until the desired up/down direction is obtained.

Move the louvers from side to side until the desired left/right direction is obtained.

Use SWING button for up/down direction

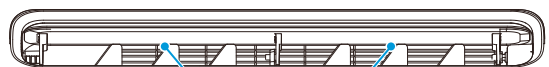
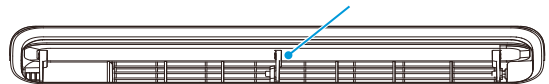

Adjust louvers for left/right direction





Air Direction

Air Conditioner Features

ELECTRONIC CONTROL OPERATING INSTRUCTIONS

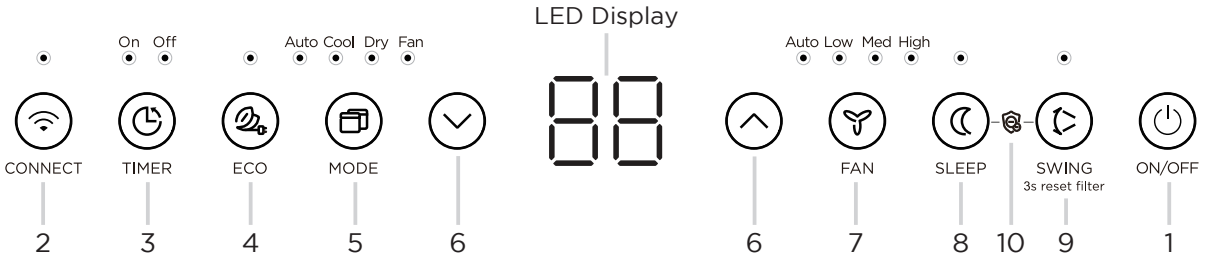
Before you begin, thoroughly familiarize yourself with the control panel as shown below and all its functions, then follow the symbol for the functions you desire. The unit can be controlled by the control panel, remote control, smartphone app or voice control.



		Description
1		ON / OFF <ul style="list-style-type: none"> • Press to turn unit on or off.
2		Connect Function <ul style="list-style-type: none"> • Press to initiate smart connection mode.
3		Timer Feature <ul style="list-style-type: none"> • Press to turn unit Auto Start/Stop.
4		Energy Saver Feature <ul style="list-style-type: none"> • Press to initiate this feature, which will maintain comfort and save energy.
5		Mode Functions <ul style="list-style-type: none"> • Press to choose operating mode in a sequence that goes from Auto, Cool, Dry and Fan.
6		Up/Down Butto <ul style="list-style-type: none"> • Press to change temperature setting.
7		Fan Speed <ul style="list-style-type: none"> • Press to select the Fan Speed in four steps - Auto, Low, Med or High.
8		Sleep Function <ul style="list-style-type: none"> • Press to initiate the sleep mode.
9		Swing / Check Filter Feature <ul style="list-style-type: none"> • Press to initiate the auto swing feature. • Press for 3 sec to turn off the cleaning filter reminder.
10		MShield Feature (For some models) <ul style="list-style-type: none"> • Press to start and stop the Ionizer.

1. ON/OFF Button

Press ON/OFF button to turn unit on or off.

2. CONNECT Button

When connecting your air conditioner to WiFi, press the CONNECT button for 3 seconds to initiate the WiFi connection mode. The display shows 'AP' to indicate the unit is in the WiFi connection mode. Refer to the WiFi section for further instructions.

If connection (router) is successful within 8 minutes, the unit will exit WiFi connection mode automatically and the CONNECT indicator illuminates.

If connection failed within 8 minutes, the unit exits WiFi connection mode automatically and the CONNECT indicator does not illuminate.

After WiFi connection is successful, you can press and hold CONNECT and DOWN (∨) buttons at the same time for 3 seconds to turn off WiFi function and the LED DISPLAY shows 'OF' for 3 seconds, press CONNECT and UP (^) buttons at the same time to turn on WiFi function and the LED DISPLAY shows 'On' for 3 seconds.

3. Timer Button: Auto Start/Stop Feature

TIMER Button

- The TIMER button allows you to enable the AUTO OFF feature and the AUTO ON feature, which allow you to set a desired time for the unit to turn off or on automatically.

To operate the AUTO OFF Feature

- While the unit is running, press the TIMER button once to enable the AUTO OFF feature.
- Press the UP and DOWN buttons to choose the desired time, in hours, to turn the unit off.

To operate the AUTO ON Feature

- When the unit is powered off, press the TIMER button once to enable the AUTO ON feature. Press the UP and DOWN buttons to choose the desired time, in hours, to turn the unit on.
- Turning the unit ON or OFF at any time or adjusting the timer setting to 0.0 will cancel the Auto Start/Stop timed program.

NOTE

To cancel timer operation, press and hold the timer button for 2 seconds until the beep/buzzer is heard.

4. ECO Button

ECO mode on by default, pressing it turns it off. This function is available on COOL, DRY, and AUTO (only AUTO-COOLING and AUTO-FAN) modes. The fan will continue to run for 3 minutes after the compressor shuts off.

The fan then cycles on for 2 minutes at 10 minute intervals until the room temperature is above the set temperature, at which time the compressor turns back on and Cooling Starts.

5. MODE Button

- To choose the operating mode, press the MODE button. Each time you press the button, a mode is selected in a sequence that goes from Auto, Cool, Dry and Fan. The indicator light beside the button will be illuminated and remain on once that mode is selected.
- When the unit is turned off and back on via the power button, the unit will automatically switch on the Energy Saver Function for the following modes: Cool, Dry, Auto.

To operate on AUTO feature:

- When you set the air conditioner to AUTO mode, it will automatically select cooling or fan only operation, depending on what temperature you have selected and the current room temperature.
- The air conditioner will automatically control the room temperature according to the temperature you've set.
- In this mode, the fan speed cannot be adjusted and is automatically controlled based on the temperature setting and room temperature.

To operate on COOL mode:

- Choose Cool Mode to set the cooling function. Use the UP (^) or DOWN (v) buttons to choose the desired temperature. When Cool Mode is selected, the fan speed can be adjusted by pressing the fan button.

To operate on DRY mode:

- In this mode, the air conditioner will generally operate as a dehumidifier. Since the conditioned space is a closed or sealed area, some degree of cooling will continue. On Dry mode, the fan speed is not adjustable.

To operate on FAN mode:

- Use this function only when cooling is not desired, such as for room air circulation. You can choose any fan speed you prefer.
- In Fan Only mode, the temperature can not be adjusted and the display will show the actual room temperature, not the set temperature as in the cooling mode.

6. UP/DOWN Button

Press UP (^) or DOWN (v) button to change temperature setting.

7. FAN SPEED Button

Press Fan button to select the Fan Speed in four steps - Auto, Low, Med or High. Each time the button is pressed, the fan speed mode is shifted.

8. SLEEP Button

Press Sleep button to initiate the sleep mode. In this mode the selected temperature will increase (in cooling mode) by 2°F (1°C) 30 minutes after the mode is selected.

This new temperature will be maintained for 7 hours before it returns to the originally selected temperature.

This ends the Sleep mode and the unit will continue to operate as originally programmed. The Sleep mode program can be cancelled at any time during operation by pressing the Sleep button again.

9. Swing Button

Use the SWING button to initiate the auto swing feature for the outlet louver. When the auto swing is on, pressing the SWING button can stop the louver at the desired angle.

Check Filter Feature:

The Check Filter feature is a reminder to clean the air filter for a more efficient operation. The light above the button will illuminate after 250 hours of operation. After cleaning the filter, press the SWING button for 3 seconds to reset the Check Filter feature turning the light off.

10. MShield Feature (For some models)

Press SWING and SLEEP at the same time for 3 seconds to initiate the MShield feature. The Mshield light will illuminate while enabled. To disable Mshield, press SWING and SLEEP again for 3 seconds until the Mshield light turns off.

Displays

LED Display:

Shows the set temperature in “°C” or “°F” and the Auto-timer settings. While on Fan Only mode, it shows the room temperature. If the room temperature is too high or low, it will display “HI” or “LO”.

To change between °F and °C, press and hold the UP (^) and DOWN (v) buttons at the same time for 3 seconds.



Error codes:

The unit may stop operation due to a malfunction with the unit. If this occurs, an error code may appear on the display like below.

Wait 10 minutes as the problem may resolve itself. If not, disconnect the power, then connect it again. Turn the unit on.

If the problem persists, disconnect the power and contact customer service.

Error code appears and begins with the letters as the following in the window display of indoor unit:

EH(xx), EL(xx), EC(xx) , PH(xx), PL(xx), PC(xx).

NOTE

If the unit turns off unexpectedly due to the power being cut, it will automatically restart with the previous function setting when the power resumes.

REMOTE CONTROL AND APP INSTRUCTIONS

Handling the Remote Control

Location of the remote control

Use the remote control within a distance of 26 ft. (8m) from the air conditioner, pointing it towards the unit. The unit will beep when it receives a signal.

CAUTION

- The air conditioner will not operate if curtains, doors or other materials block the signals from the remote control to the unit.
- Prevent any liquid from spilling onto the remote control. Do not expose the remote control to direct sunlight or heat.
- If the infrared signal receiver on the indoor unit is exposed to direct sunlight, the air conditioner may not function properly. Use curtains to prevent the sunlight from falling on the receiver.
- If other electrical appliances react to the remote control, either move these appliances or consult your local dealer.

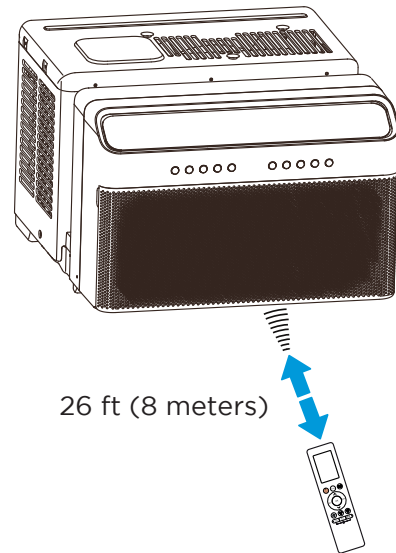

Inserting and Replacing Batteries

Your air conditioning unit may come with two batteries (some units). Put the batteries in the remote control before use.

1. Slide the back cover from the remote control downward, exposing the battery compartment.
2. Insert the batteries, paying attention to match up the (+) and (-) ends of the batteries with the symbols inside the battery compartment.
3. Slide the battery cover back into place.

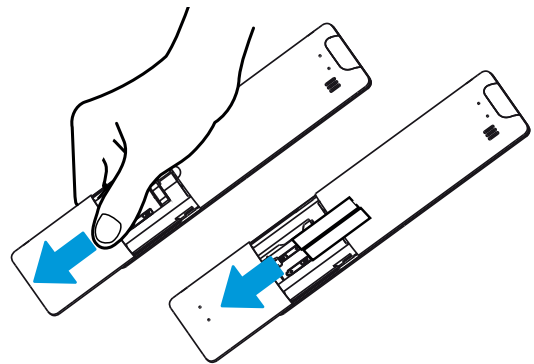

Remote Control Specifications

Rated Voltage	3.0V (Dry batteries R03/LR03x2)
Signal Receiving Range	26 ft (8 m)
Environment	-5 °C ~ 60 °C (23°F ~ 140°F)

Function Buttons

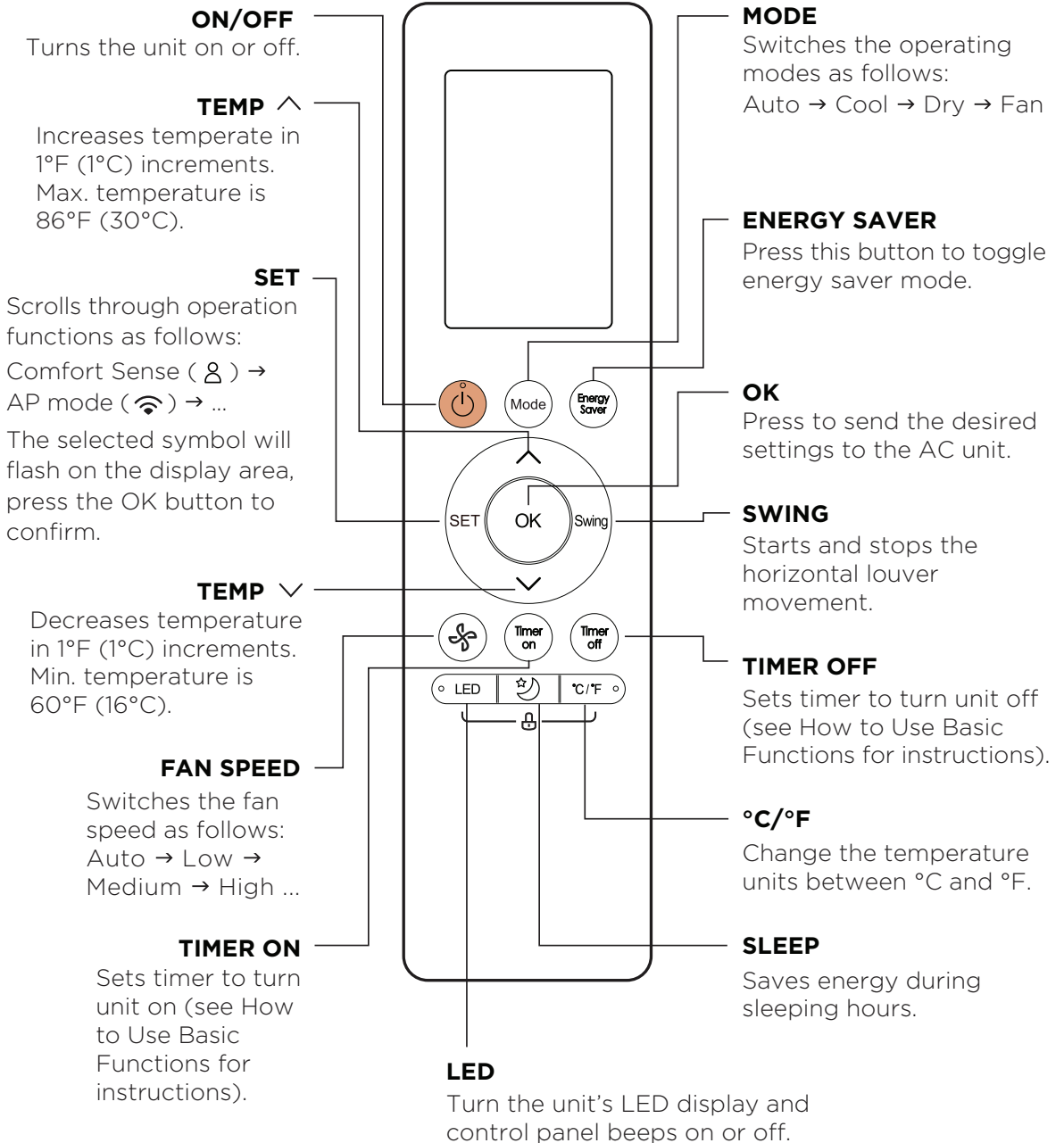

Remote Screen Indicators

Information is displayed when the remote control is powered on.

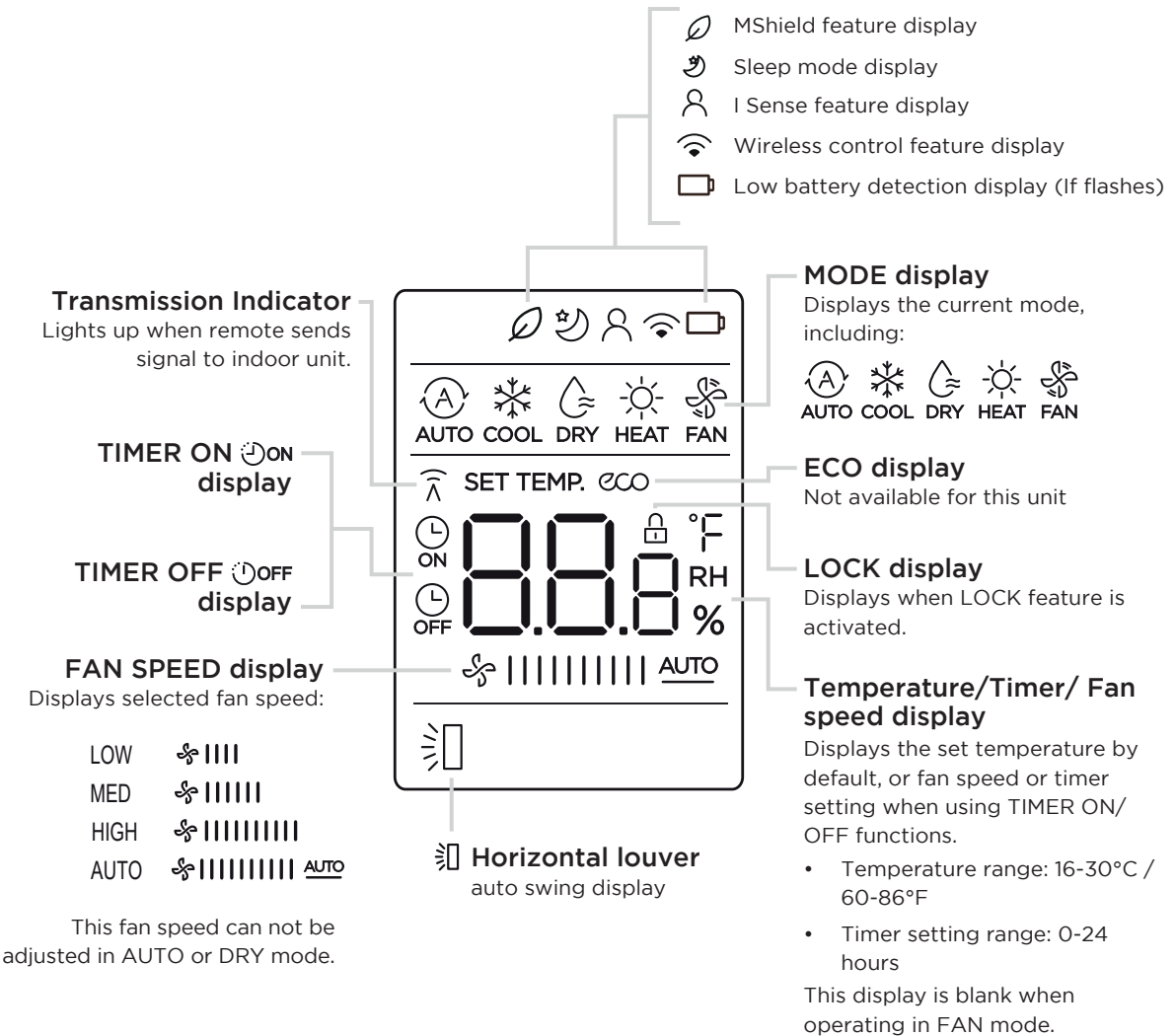

Supplier's Declaration of Conformity 47 CFR § 2.1077 Compliance Information

Unique Identifier: Midea RG10G2(B2)/BGEFU1

Responsible Party U.S. Contact Information

Midea America Corporation
300 Kimball Dr
Parsippany NJ
07054

Telephone number or internet contact information: Midea.com/us

FCC Compliance Statement (products subject to Part 15)

This device complies with Part 15 of the FCC Rules. Operation is subject to the following two conditions: (1) This device may not cause harmful interference, and (2) this device must accept any interference received, including interference that may cause undesired operation.

Setting the TIMER

TIMER ON/OFF

Set the amount of time after which the unit will automatically turn on/off.

TIMER ON SETTING

Press TIMER ON button to initiate the ON time sequence.

Press up or down button for multiple times to set the desired time to turn on the unit.

Point remote to unit and wait 1sec, the TIMER ON will be activated.

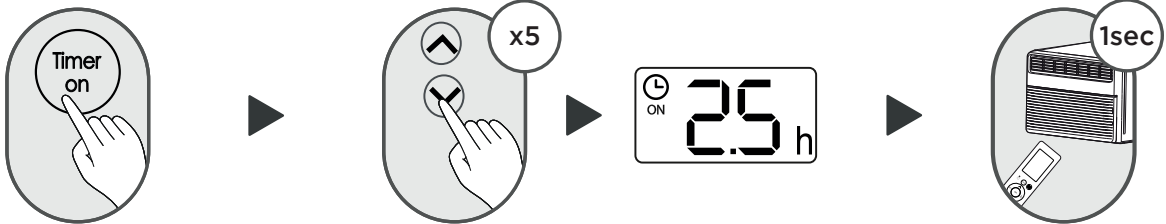

TIMER OFF SETTING

Press TIMER OFF button to initiate the OFF time sequence.

Press up or down button for multiple times to set the desired time to turn off the unit.

Point remote to unit and wait 1sec, the TIMER OFF will be activated.

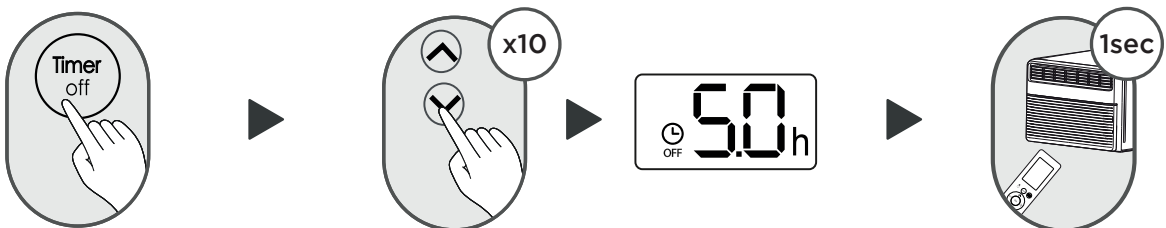

NOTE

1. When setting the TIMER ON or TIMER OFF, the time will increase by 30 minutes increments with each press, up to 10 hours. After 10 hours and up to 24, it will increase in 1 hour increments. (For example, press 5 times to get 2.5h, and press 10 times to get 5h,). The timer will revert to 0.0 after 24.
2. Cancel either function by setting its timer to 0.0h.

TIMER ON & OFF SETTING (example)

Keep in mind that the time periods you set for both functions refer to hours after the current time.

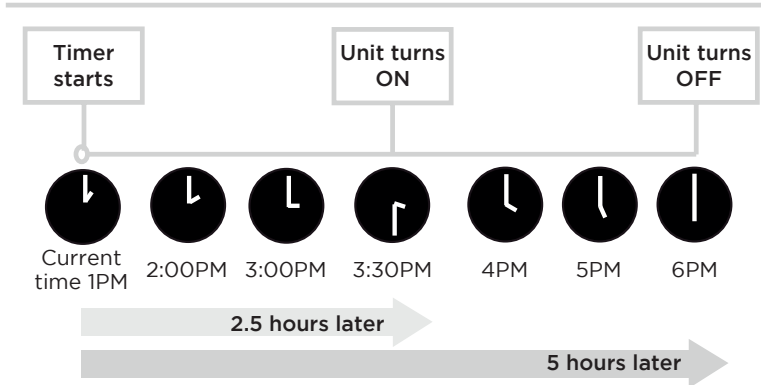
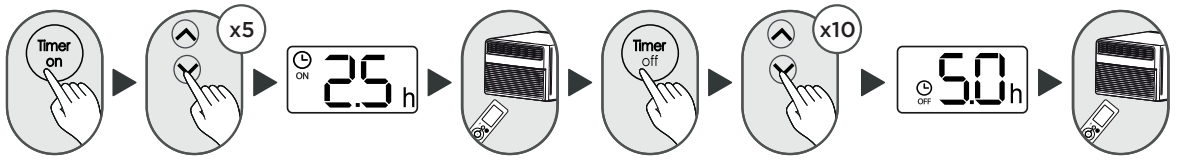

Example: If current timer is 1:00PM, to set the timer as above steps, the unit will turn on 2.5h later (3:30PM) and turn off at 6:00PM.

Declaration of Conformity

We hereby declare that this AC is in compliance with the essential requirements and other relevant provisions of Directive 1999/5/EC.

Specification of Wireless Module

Model: US-SK109	Dimensions: 41 x 24 x 5 (mm)
Antenna Type: Printed PCB Antenna	Operation Temperature: 0°C ~ 45°C / 32°F ~ 113°F
Frequency: WLAN 2400-2483.5 MHz	Operation Humidity: 10% ~ 85%
Maximum Transmitted Power: <20 dBm Max	Power Input: DC 5V/500 mA

1 How to use SmartHome App

- ⚠ Ensure that your mobile phone is connected to the wireless network. Bluetooth must be turned on. The device must also be powered up.

■ Step 1: Download the SmartHome app

Scan the QR code below to download the SmartHome app from app store or search for it directly on the Google Play Store or Apple's App Store.



■ Step 2: Log in

Open the SmartHome app. Log in directly if you have an existing SmartHome account or create a new account. Alternatively, you can also use a 3rd party login platform.

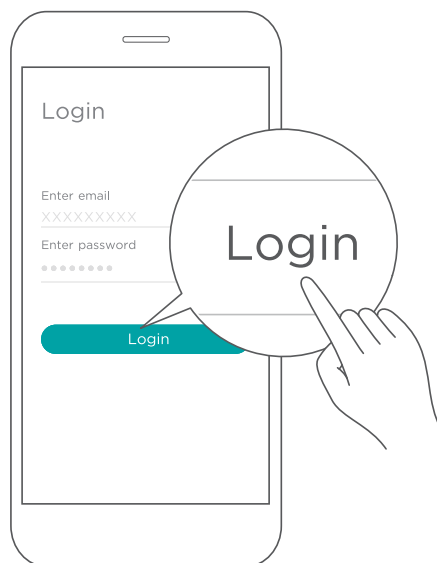

■ Step 3: Connecting the device

1) When you log in, you may see the message "Smart devices discovered nearby". Tap to add your device.



2) If no such message appears, proceed as follows: Tap on "+" and select your device in the list of nearby available devices.

If your device is not listed, please add your device manually, first selecting the device category e.g. Window AC.

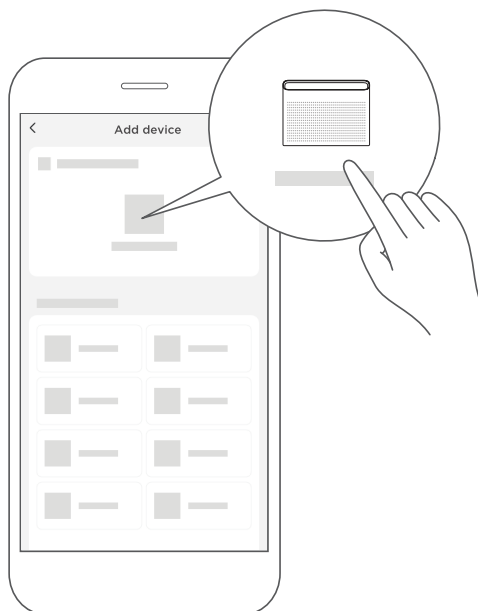

3) Follow the steps in the app to connect your device to the wireless network. If your device fails to connect, follow the additional instructions in the app.

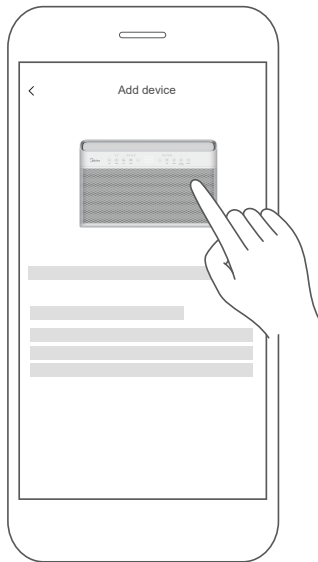

For Window AC



For Portable AC

■ Step 4: Controlling the device

After pairing successfully, a card will be created for the device in the SmartHome app.

Shortcuts for basic functions will appear on the card such as changing the temperature or switching the device on or off.

Tapping on the card, will reveal additional features and settings. The actual UI design may look different from examples due to app updates.

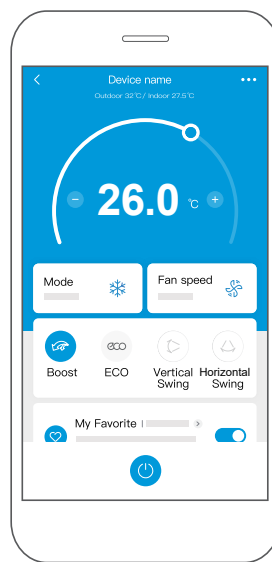
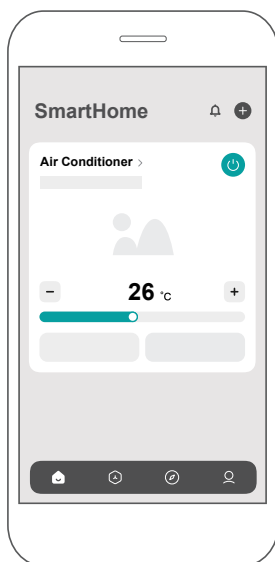

2 How to use Matter

Matter is a connectivity technology that unifies the smart home by allowing devices and ecosystems (such as Alexa, Google Home and Apple Home) to speak the same language thus creating exciting new features and use cases.

To use Matter, you will need at least one Matter enabled smart speaker from Amazon, Google or Apple, and it's respective app.

-- If you have a Matter enabled smart speaker, please proceed to the "How to use Matter" instructions on the following pages.

-- If you don't have a Matter enabled smart speaker, you won't be able to use Matter right now. However, you can still achieve full functionality of the product by using our SmartHome app. To do this, proceed to the "How to use SmartHome app" section back on page 1.

Connect Your Air Conditioner through Matter

⚠ Make sure your mobile device is connected to your wireless router.

Wireless router should support and turn on IPv6. Please make sure your smartphone connect to 2.4G but not 5G network.

■ Step 1: Connect to smart speaker

Select your preferred ecosystem (Alexa, Google Home or Apple Home) and make sure you've got one of their Matter enabled products (such as their smart speakers) connected to your wireless router.

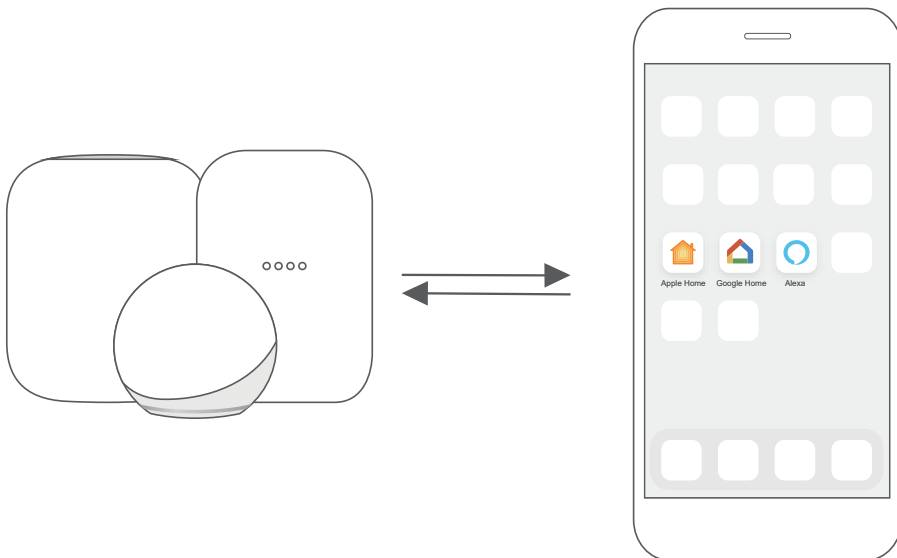

■ Step 2: Turn on Bluetooth

Turn on Bluetooth on your mobile device.

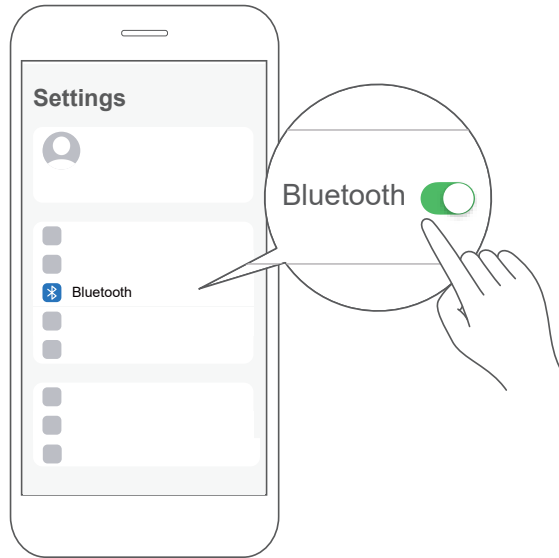

■ Step 3: Enter AP mode

Window AC: Hold down the CONNECT / Power button for 3 seconds to begin the pairing process ("AP" will appear on the AC's display).

Portable AC: Hold down the SWING / Power button for 3 seconds to begin the pairing process ("AP" will appear on the AC's display).

Note: Entering AP pairing mode may vary between different AC, please follow instruction of AC panel.

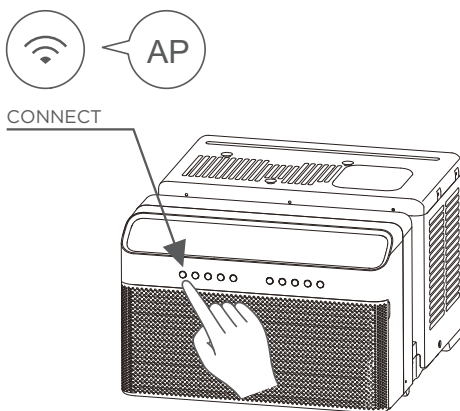

Window AC

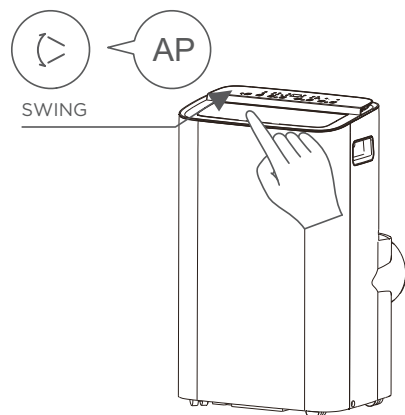

Portable AC

■ Step 4: Open app

Open the Alexa, Google Home, Apple Home app on your mobile device.

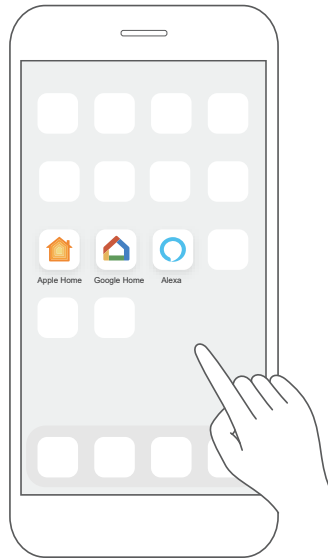

■ Step 5: Scan matter QR code

Tap the "+" and "Add Device/Accessory" or tap "+Add" in your app and then select Matter device and scan the Matter QR code found on the side of the AC device. Follow the respective instructions in the Alexa, Google Home or Apple Home app to complete the pairing process.

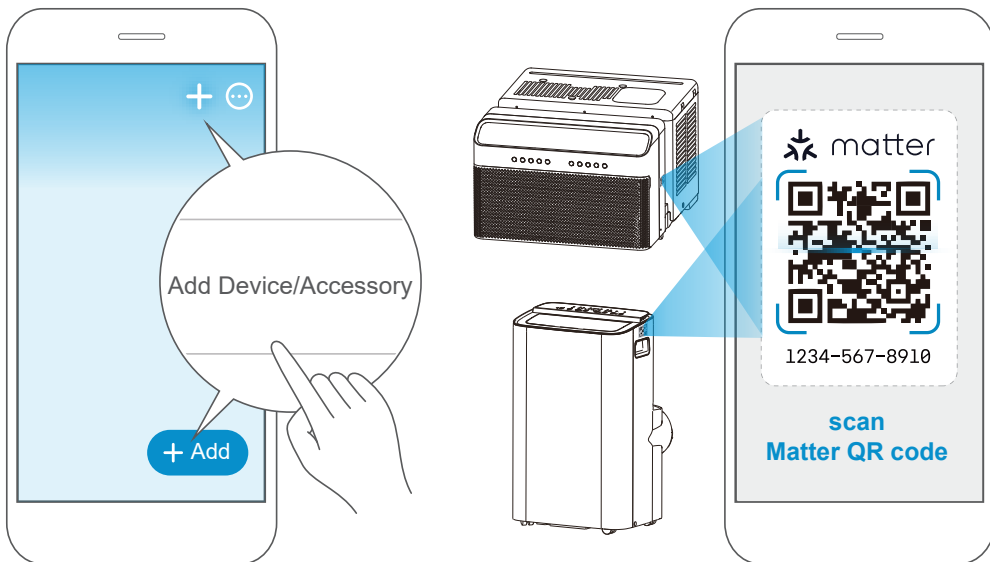

■ Step 6: Control device

After pairing is successful, you can control your AC's temperature and mode settings, etc. through the respective ecosystem app and smart speaker.

Due to a compatibility issue, the temperature value shown in the Alexa, Google Home or Apple Home app may be 1 degree different from that displayed on the air conditioner. However, this will not impact the device's ability to cool the room.

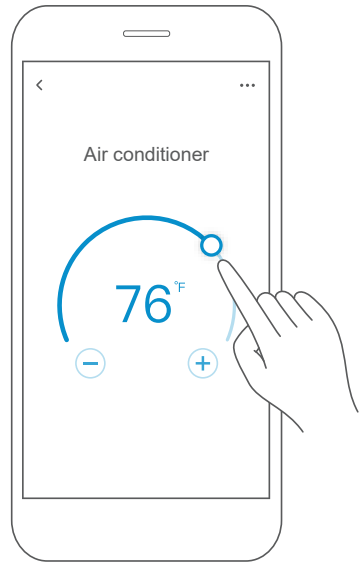
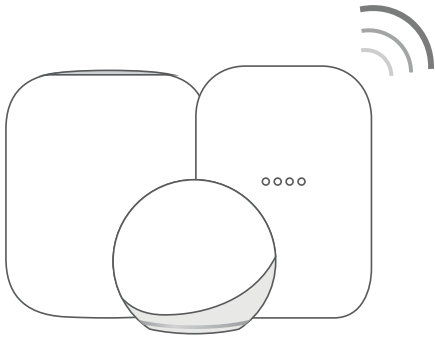

■ Declaration of conformity

FCC ID: 2ADQOMDNA23
IC: 12575A-MDNA23

This device complies with Part 15 of the FCC Rules and Industry Canada's licenceexempt RSSs.

Operation is subject to the following two conditions:

- (1) This device may not cause interference;
- (2) This device must accept any interference, including interference that may cause undesired operation of the device.

Only operate the device in accordance with the instructions supplied.

Changes or modifications to this unit not expressly approved by the party responsible for compliance could void the user's authority to operate the equipment.

This device complies with FCC radiation exposure limits set forth for an uncontrolled environment. In order to avoid the possibility of exceeding the FCC radio frequency exposure limits, human proximity to the antenna shall not be less than 20cm (8 inches) during normal operation.

NOTE:

This equipment has been tested and found to comply with the limits for a Class B digital device, pursuant to part 15 of the FCC Rules. These limits are designed to provide reasonable protection against harmful interference in a residential installation.

This equipment generates, uses and can radiate radio frequency energy and, if not installed and used in accordance with the instructions, may cause harmful interference to radio communications. However, there is no guarantee that interference will not occur in a particular installation. If this equipment does cause harmful interference to radio or television reception, which can be determined by turning the equipment off and on, the user is encouraged to try to correct the interference by one or more of the following measures:

- Reorient or relocate the receiving antenna.
- Increase the separation between the equipment and receiver.
- Connect the equipment into an outlet on a circuit different from that to which the receiver is connected.
- Consult the dealer or an experienced radio/TV technician for help.

We, hereby declare that this device is in compliance with the relevant provisions of RE Directive 2014/53/EU. A copy of the full DoC is attached (European Union products only).

App & Smart Speakers can support Matter only when using these versions or above.

Device	Version
iPhone	iOS 16.5
Apple Home Pod	16.5
Android	Google Play services min version: 22.36.15 Google Home app (GHA) min version: 2.58.24.1-dogfood
Google Home Hub	Google Hub firmware min version: 1.56.324896 (appears on hub as Chromecast firmware version)
Alexa App	2.2.536317
Alexa Echo Device	9094439556

NOTE:

- Setup processes and features may vary between ecosystems.
- The functions shown in the Alexa, Google Home or Apple Home apps may change with updates to their products or apps.
- Make sure the Matter enabled app is up to date to ensure the best experience.
- Periodically, we will update the device's software to improve the experience. Device software updates can be accomplished through the SmartHome app.
-  **matter** is developed by the Connectivity Standards Alliance TM. This brand, related logos, and marks are trademarks of the Alliance, all rights reserved.
- Use of the Works with Apple badge means that an accessory has been designed to work specifically with the technology identified in the badge and has been certified by the developer to meet Apple's performance standards.
Apple is not responsible for the operation of this device or its compliance with safety and regulatory standards.

CLEANING AND MAINTENANCE

CAUTION

Clean your air conditioner occasionally to keep it looking new. Be sure to unplug the unit before cleaning to prevent shock or fire hazards.

Air Filter Cleaning

The air filter should be checked at least once every two weeks to see if cleaning is necessary. Trapped particles in the filter can build up and reduce performance by restricting airflow through the coils.

- Grasp the filter by the center and pull up and out.
- Wash the filter using warm water. Rinse filter thoroughly.
- Gently shake excess water from the filter. Be sure the filter is thoroughly dry before replacing.
- Instead of washing, you may also vacuum the filter clean.

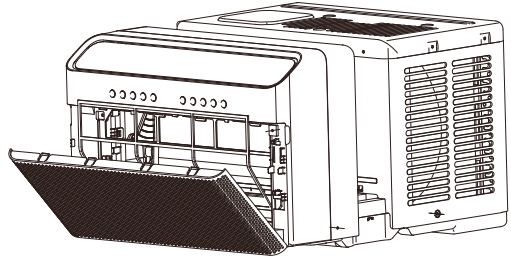

NOTE

Never use hot water over 104°F (40°C) to clean the air filter. Never attempt to operate the unit without the air filter.

Cabinet Cleaning

- Be sure to unplug the air conditioner to prevent shock or fire hazard. The cabinet and front may be dusted with an oil-free cloth or washed with a cloth dampened in a solution of warm water and mild liquid dishwashing detergent. Rinse thoroughly and wipe dry.
- Never use harsh cleansers, wax, or polish on the air conditioner.
- Be sure to wring excess water from the cloth before wiping around the controls. Excess water in or around the controls will cause damage to the air conditioner.
- Plug in air conditioner.

Winter Storage

If you plan to store the air conditioner during the winter, remove it carefully from the window according to the installation instructions. Be careful not to spill any potentially standing water from the unit's base pan. If water is present, carefully drain it. Cover the unit with plastic or return it to the original carton and store in a cool dry place.

TROUBLESHOOTING TIPS

Before calling for service, review this list. It may save you time and expense. This list includes common occurrences that are not the result of defective workmanship or materials in this appliance.

Problem	Solution
Air conditioner does not start.	Wall plug disconnected. Push plug firmly into wall outlet.
	Circuit breaker tripped. Reset circuit breaker.
	Check if the light on the plug is on. If it is off, press the RESET button.
	Power is OFF. Turn power ON.
Air from unit does not feel cold enough.	Unit turned off and then on quickly. Turn unit off and wait 3 minutes before restarting.
	Room temperature below 62°F (17°C). Cooling may not occur until room temperature rises above 62°F (17°C).
	Temperature sensor behind the air filter is touching the cold coil. Try to move it so it does not contact the cold coil.
	Reset to a lower temperature.
	Compressor shut-off by changing modes. Wait approximately 3 minutes and listen for compressor to restart when set in the COOL mode.
Check for potential obstructions blocking the outdoor intake/exhaust. Clear any obstructions.	
Air conditioner cooling, but room is too warm- ice forming on cooling coil behind air filter.	Outdoor temperature below 64°F (18°C). To defrost the coil, set to FAN ONLY mode.
	Air filter may be dirty. Clean filter. Refer to Care and Cleaning section. To defrost, set to FAN ONLY mode.
	Thermostat set too cold for night-time cooling. To defrost the coil, set to FAN ONLY mode. Then, set temperature to a higher setting.
Air conditioner cooling, but room is too warm- NO ice forming on cooling coil behind air filter.	Dirty or restricted air filter. Clean filter. Refer to Care and Cleaning section. To defrost, set to FAN ONLY mode.
	Temperature is set too high, set temperature to a lower setting.
	Air directional louvers positioned improperly. Position louvers for better air distribution.
	Front of unit is blocked by drapes, blinds, furniture, etc. - restricts air distribution. Clear obstruction in front of unit.
	Any open doors, windows, or vents may allow cold air to escape. Close any doors, windows, or vents.
	The room may be too warm. Allow additional time to remove "stored heat" from walls, ceiling, floor and furniture.

Problem	Solution
Air conditioner turns on and off rapidly.	Dirty air filter- air restricted. Clean air filter.
	Outside temperature extremely hot. Set FAN speed to a higher setting to bring air past cooling coils more frequently.
	Check for potential obstructions blocking the outdoor intake/exhaust. Clear any obstructions.
Noise when unit is cooling.	Air movement sound. This is normal. If too loud, set to a slower FAN setting.
	Window vibration - poor installation. Refer to installation instructions or check with installer.
Water dripping INSIDE when unit is cooling.	Improper installation. Tilt air conditioner slightly to the outside to allow water drainage. Refer to installation instructions - check with installer.
Water dripping OUTSIDE when unit is cooling.	Unit removing large quantity of moisture from humid room. This is normal during excessively humid days.
Remote sensing deactivating prematurely (some models).	Remote control not located within range. Place remote control within 26 feet & 180°, radius of the front of the unit, and pointed in the general direction of the air conditioner unit.
	Remote control signal obstructed. Remove obstruction.
Room too cold.	Temperature setting too low. Increase temperature setting.
Noise when unit starts.	A 30 second high pitched noise may occur when the unit is turned on due to the compressor starting, This is normal.
Window does not insert into the U-shaped slot.	Ensure that the “U-shaped” slot is in line with the window, if not, align the slot with the window. Ensure that the unit is not slanted too much to cause interference with the top of the unit. Reference the installation instructions for more information.
Unit will not connect to Wireless or App does not work (some models).	For additional support and troubleshooting tips, visit the “Help” tab within the SmartHome app.

WARRANTY

Air Conditioner Limited Warranty

Your product is protected by this Limited Warranty:

Warranty service must be obtained from Midea Consumer Services or an authorized Midea servicer.

Warranty

- One Year Limited Warranty from original purchase date. Five Year Limited Sealed System Warranty (includes components containing refrigerant) from original purchase date. Three Year Limited Compressor Warranty from original purchase date.

Midea, through its authorized servicers will:

- Pay all costs for repairing or replacing parts of this appliance which prove to be defective in materials or workmanship.

Consumer will be responsible for:

- Diagnostics, removal, transportation and reinstallation cost required because of service.
- Costs of service calls that are a result of items listed under NORMAL RESPONSABILITIES OF THE CONSUMER**

Midea replacement parts shall be used and will be warranted only for the original warranty.

NORMAL RESPONSABILITIES OF THE CONSUMER**

This warranty applies only to products in ordinary household use, and the consumer is responsible for the items listed below:

1. Proper use of the appliance in accordance with instructions provided with the product.
2. Routine maintenance and cleaning necessary to keep the good working condition.
3. Proper installation by an authorized service professional in accordance with instructions provided with the appliance and in accordance with all local plumbing, electrical and/or gas codes.
4. Proper connection to a grounded power supply of sufficient voltage, replacement of blown fuses, repair of loosen connections or defects in house wiring.
5. Expenses for making the appliance accessible for servicing.
6. Damages to finish after installation.

EXCLUSIONS

This warranty does not cover the following:

- 1) Failure caused by damage to the unit while in your possession (other than damage caused by defect or malfunction), by its improper installation, or by unreasonable use of the unit, including without limitation, failure to provide reasonable and necessary maintenance or to follow the written installation and Operating Instructions.
- 2) Damages caused by serviced performed by persons other than those authorized by Midea customer service; or external causes such as abuse, misuse, inadequate power supply or acts of God.
- 3) If the unit is put to commercial, business, rental, or other use or application other than for consumer use, we make no warranties, express or implied, including but not limited to, any implied warranty of merchantability or fitness for use or purpose.
- 4) Products without original serial numbers or products that have serial numbers which have been altered or cannot be readily determined.

NOTICE: Some states do not allow the exclusions or limitation of incidental or consequential damages. So this limitation or exclusion may not apply to you.

IF YOU NEED SERVICE

Keep your bill of sale, delivery slip, or some other appropriate payment Record.

The date on the bill establishes the warranty period, should service be required.

If service is performed, it's your best interest to obtain and keep all receipts.

This written warranty gives you specific legal rights. You may also have other rights that vary from state to state.

Service under this warranty must be obtained by following these steps, in order:

- 1) Contact Midea Consumer Services or an authorized Midea services at 1 866 646 4332.
- 2) If there is a question as to where to obtain service, contact our consumer relations Department.

TRADEMARKS, COPYRIGHTS AND LEGAL STATEMENT

 Midea logo, word marks, trade name, trade dress and all versions thereof are valuable assets of Midea Group and/or its affiliates (“Midea”), to which Midea owns trademarks, copyrights and other intellectual property rights, and all goodwill derived from using any part of an Midea trademark. Use of Midea trademark for commercial purposes without the prior written consent of Midea may constitute trademark infringement or unfair competition in violation of relevant laws.

This manual is created by Midea and Midea reserves all copyrights thereof. No entity or individual may use, duplicate, modify, distribute in whole or in part this manual, or bundle or sell with other products without the prior written consent of Midea.

All the described functions and instructions were up to date at the time of printing this manual. However, the actual product may vary due to improved functions and designs.

DATA PROTECTION NOTICE

For the provision of the services agreed with the customer, we agree to comply without restriction with all stipulations of applicable data protection law, in line with agreed countries within which services to the customer will be delivered, as well as, where applicable, the EU General Data Protection Regulation (GDPR).

Generally, our data processing is to fulfil our obligation under contract with you and for product safety reasons, to safeguard your rights in connection with warranty and product registration questions. In some cases, but only if appropriate data protection is ensured, personal data might be transferred to recipients located outside of the European Economic Area.

Further information are provided on request. You can contact our Data Protection Officer via **MideaDPO@midea.com**. To exercise your rights such as right to object your personal data being processed for direct marketing purposes, please contact us via **MideaDPO@midea.com**. To find further information, please follow the QR Code.

The design and specifications are subject to change without prior notice for product improvement. Consult with the sales agency or manufacturer for details. Any updates to the manual will be uploaded to the service website, please check for the latest version.



make yourself at home



www.midea.com

© Midea 2023 all rights reserved

CW009UI-QB

16120300A31472

20230823