







# Assembly Instructions

**Caution : You must read this before you proceed**



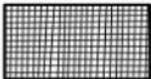

## Storage Trunk



### Part List

Label	Picture	Description	QTY
A		Side Panel with Hinge Joints to connect the Top Lid	1
B		Panel	1
C		Panel with Wheels	1
D		Side Panel	1
E		Base Panel	1
F		Trunk-Inner Lining	1
G		Lid -Top Panel with pressure hinge	1





# Hardware

Label	Picture	Description	QTY
①		Bolt( M6*40mm)	9
②		Bolt (M6*20mm)	9
③		Bolt (M6*60mm)	4
④		Washer	22
⑤		Washer Ring (PVC gasket)	3
⑥		Allen Key	1
⑦		M6 Washer Nut	4
⑧		Wrench	1

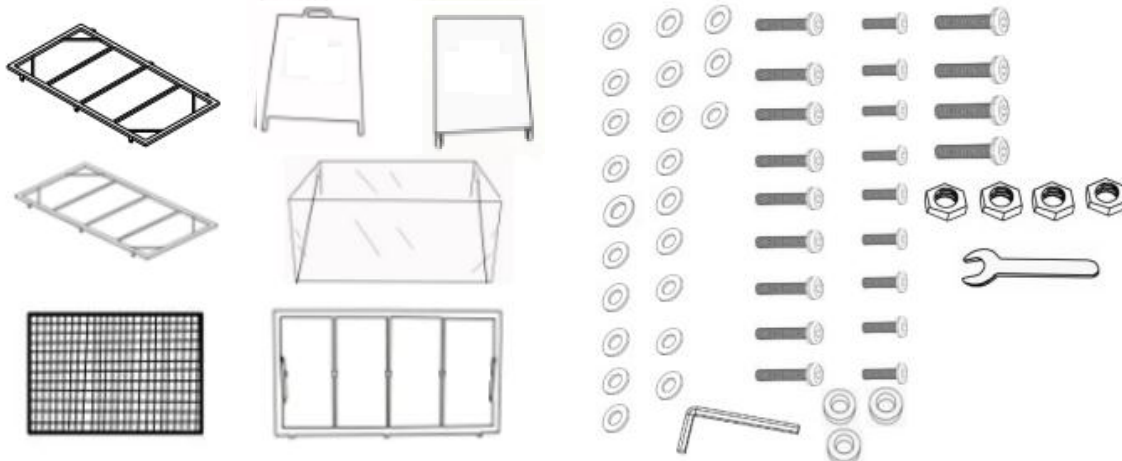
# Assembly Preparation

Before Beginning Assembly:



-  • Read instructions, cover to cover-
-  • Have 2 adults on hand for assembly-
-  • Do not assemble on flooring or carpet-
-  • Assemble on a clean non-marring surface (packing foam)-
-  • Save all packaging until finished-

# Assembly Steps

## Overview

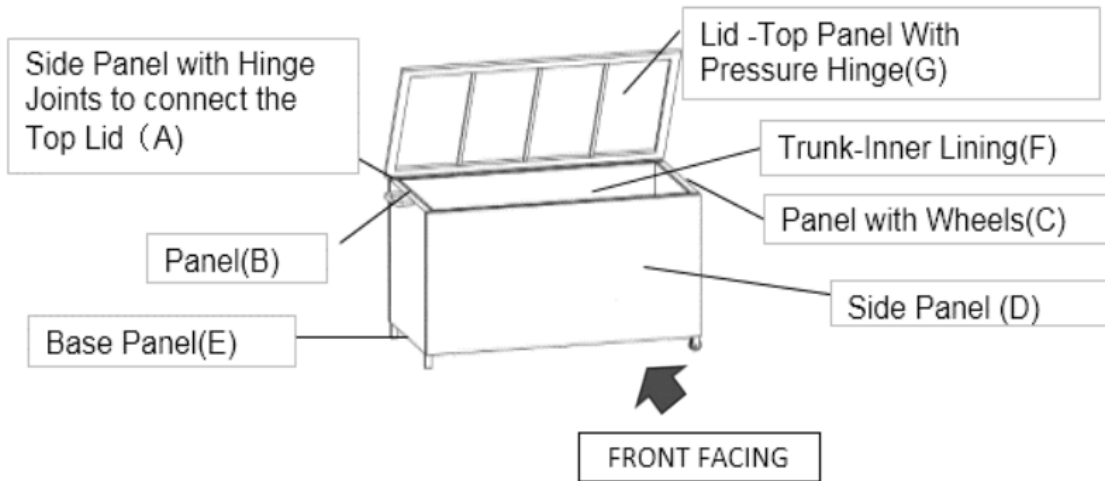

This Storage Trunk has multiple parts and may require up to 15 minutes to assemble. To give you an overview of the Storage Trunk parts, the above picture is to help you put the various parts into perspective. Please read through the instructions below to familiarise yourself with the parts and steps before assembly.

## Step 1

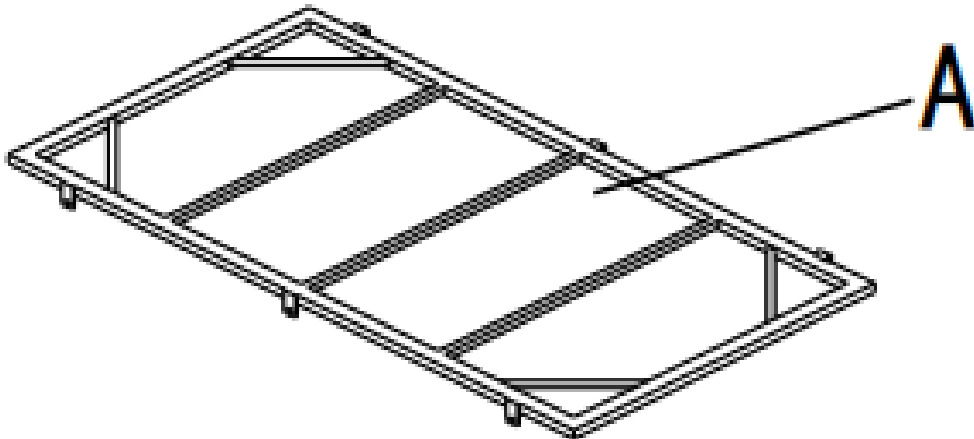

Open the carton and place all the parts onto a clean, non-marring surface. Attach the Mounting Cross(B) to Table Leg(C) using Bolt(①) with Allen Key(③) as shown in Picture Fully tighten at this stage.

## Step 2

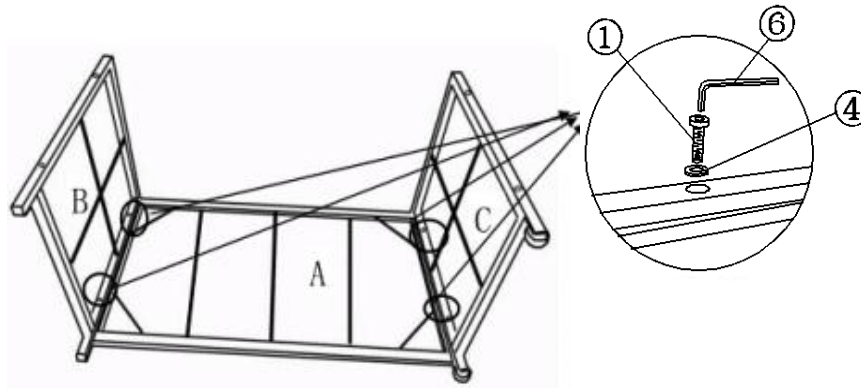

Affix the mounting points in Side Panel with Hinge Joints to connect the Top Lid(A) and Panel (B). Then,repeat the same process with mounting points in Side Panel with Hinge Joints to connect the Top Lid (A) and Panel with Wheels(C).

As shown in the picture above use Bolts(①) and Washers(④) with Allen Key(⑥),to attach these mounting points.

Do not fully tighten the Bolts.

## Step 3

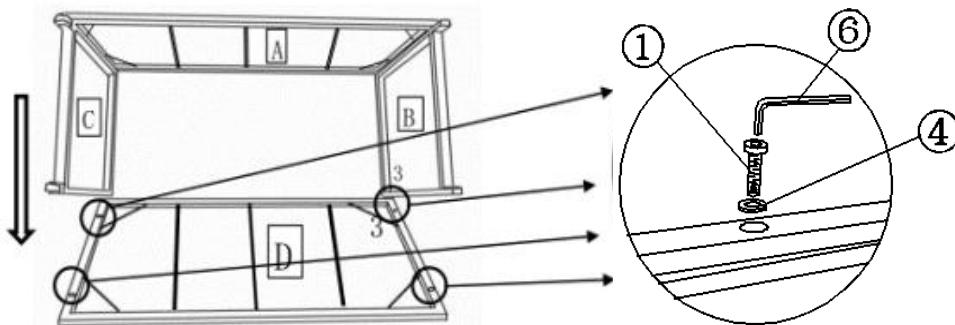

Turn over the above preattached A B C Panels.

Attach Side Panel (D) to Panel with Wheels(C) and Panel(B) using Bolts(①) and Washers(④) with Allen Key(⑥) as shown in the picture above.

Do not fully tighten Bolts.

## Step 4

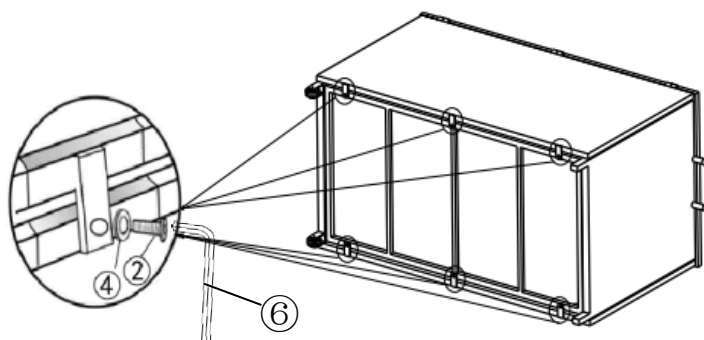

Attach Base Panel(E) to the four Side Panels using Bolts(②) and Washers(④) with Allen Key(⑥) as shown in the picture above.

Do not fully tighten the Bolts.

## Step 5

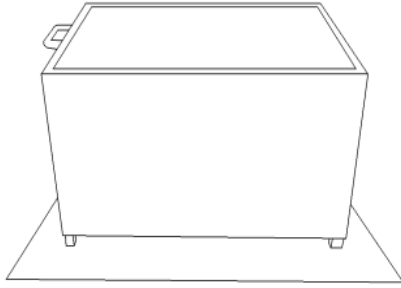

Stand the Storage Trunk up.

Place the Storage Trunk on a level surface to check for wobbles.

If it wobbles, apply steady and even pressure down on the Storage Trunk with the help of an adult partner.

Then fully tighten all the bolts.

## Step 6

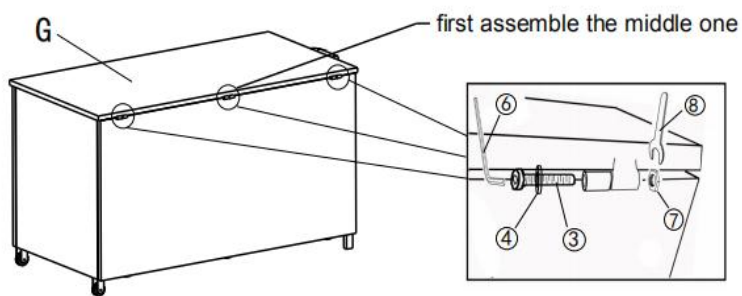

Put the Lid Top Panel (G) as shown above.

Match the three hinge points.

Once the hinge points matches, place Bolts (③) and Washers (④) through and fix by M6 Washer Nut (⑦) & Wrench (⑧) with Allen Key (⑥) as shown in the picture.

## Step 7

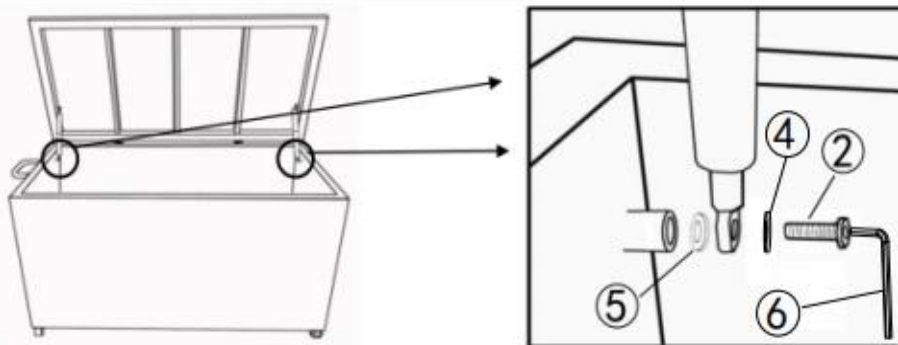

Turn in and lock the Bolts (②) using Allen Key (⑥) as shown in the picture.

One sides of the pressure hinge arm, would require Washer Ring (⑤).

the other side require Washer (④)

## Step 8

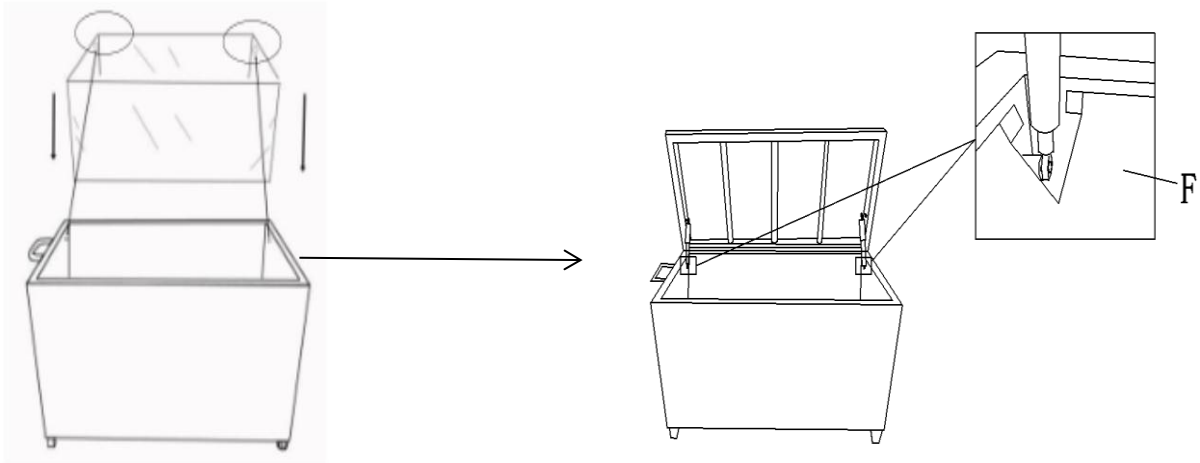

Spread out the Trunk Linner Lining (F).

Set as shown into the box.

Then smooth out the corresponding Velcro tapes till all tapes meets and seals tightly.

There are 2 holes in the Lining that shall be aligned into the pressure hinge mounting point.

## Step 9



Now go back to all the Bolts that are previously attached.

Once all Bolts are fully tighten in.

In a sequential manner, fully secure and tighten up all nuts and bolts.

Place the Trunk Lining into storage.





















Spread out the Trunk Inner Lining(F).

Smooth out the corresponding Velcro tapes till all tapes meets and seals tightly.

Your Storage Trunk is ready for use.

This Storage Trunk should only be used on a flat, level surface.

## Care & Maintenance

-   ● Do not put hot items directly on furniture surface
  -   ● Do not clean furniture with harsh cleansers or polish.
  -   ● To obtain the longest lifespan of your outdoor products, minimizing exposure to direct sunlight is recommended.
  -   ● Children should not climb or jump on the furniture.
  -   ● Do not write on furniture without a padded barrier to protect the surface.
  -   ● To obtain the longest lifespan of your outdoor products, avoid extended and lengthy exposure to rain, snow, and direct sunshine. Whenever possible cover the product and /or place under patio or awnings.
  -   ● Not for commercial use. For residential use only .
  -   ● Stains may be removed with mild soap solution and damp cloth.
  -   ● Keep away from sources of ignition.
- 
-   ● Dust and pick-up spills using a clean, non-colored, lint-free cloth .

### Questions & Answers about Proposition 65

#### • What is Proposition 65?

Proposition 65 requires businesses to provide warnings to Californians about significant exposures to chemicals that cause cancer, birth defects or other reproductive harm. These chemicals can be in the products that Californians purchase, in their homes or workplaces, or that are released into the environment. By requiring that this information be provided, Proposition 65 enables Californians to make informed decisions about their exposures to these chemicals.

Proposition 65 also prohibits California businesses from knowingly discharging significant amounts of listed chemicals into sources of drinking water.

Proposition 65 requires California to publish a list of chemicals known to cause cancer, birth defects or other reproductive harm. This list, which must be updated at least once a year, has grown to include approximately 900 chemicals since it was first published in 1987.

#### • What types of chemicals are on the Proposition 65 list?

The list contains a wide range of naturally occurring and synthetic chemicals that include additives or ingredients in pesticides, common household products, food, drugs, dyes, or solvents. Listed chemicals may also be used in manufacturing and construction, or they may be byproducts of chemical processes, such as motor vehicle exhaust.

#### • What does a warning mean?

If a warning is placed on a product label or posted or distributed at a workplace, a business, or in rental housing, the business issuing the warning is aware or believes that it is exposing individuals to one or more listed chemicals.

By law, a warning must be given for listed chemicals unless the exposure is low enough to pose no significant risk of cancer or is significantly below levels observed to cause birth defects or other reproductive harm.

#### • Where can I get more information on Proposition 65?

If you have specific questions on the administration or implementation of Proposition 65, you can contact OEHHA's Proposition 65 program at [P65.Questions@oehha.ca.gov](mailto:P65.Questions@oehha.ca.gov), or by phone at (916) 445-6900.