

**WARNING**

WE RECOMMEND INSTALLATION OF THIS LIGHTING FIXTURE BE DONE BY A LICENSED ELECTRICIAN.  
 WARNING \*\*\* SWITCH OFF THE MAIN ELECTRICAL SUPPLY FROM THE MAIN FUSE BOX/CIRCUIT BREAKER BEFORE INSTALLATION.  
 INSPECT ITEM CAREFULLY BEFORE ATTEMPTING TO INSTALL. IF THERE IS ANY DAMAGE OR OBVIOUS DEFECT, DO NOT INSTALL. ITEM MAY NOT BE RETURNED ONCE IT HAS BEEN INSTALLED.

















**CARE AND MAINTENANCE**

To clean the outside of the fixture, use a dry or slightly dampened clean cloth (use clean water, never a solvent) to wipe the surface of the fixture.  
 To clean the inside of the fixture, first disconnect power to the fixture by turning off the circuit breaker or by removing the fuse at the fuse box. Next, use a dry or slightly dampened clean cloth (use clean water, never a solvent) to wipe the interior surface of the fixture.  
 Do not use any cleaners with chemical, solvents or harsh abrasives. Use only a dry soft cloth to dust or wipe carefully.

**NOTICE& IMPORTANT SAFETY INSTRUCTIONS**

- \* Please make sure that you have all parts indicated before you begin assembly of this item
- \* This item should be assembled on a soft surface to prevent scratching the finish during assembly
- \* To reduce the risk of fire, electrical shock or injury to persons or property, please follow the guideline below for safe use and installation
- \*The external flexible cable or cord of this lamp cannot be replaced  
 If the cord is damaged, the lamp shall be destroyed

**Part List and Hardware List**

PIECE	DESCRIPTION	PICTURE	QUANTITY	PIECE	DESCRIPTION	PICTURE	QUANTITY
A	fixed connector		4X	J	plastic anchors		2X
B	wire connector		3X	K	tapping screws		2X
C	mounting screw		2X	L	glass shape		4X
D	mounting bracket		1X	M	rod		12X
E	machine screw		2X	N	cup		4X
F	ball nut		2X	O	crystal		4X
G	wire		4X	P	connector		4X
H	driver		1X	Q	screw driver		1X
I	canopy		1X				

**Model#: JYL1706**  
**Product Dimensions: 29.5"Lx 4.25"W x 18"H-77"H**

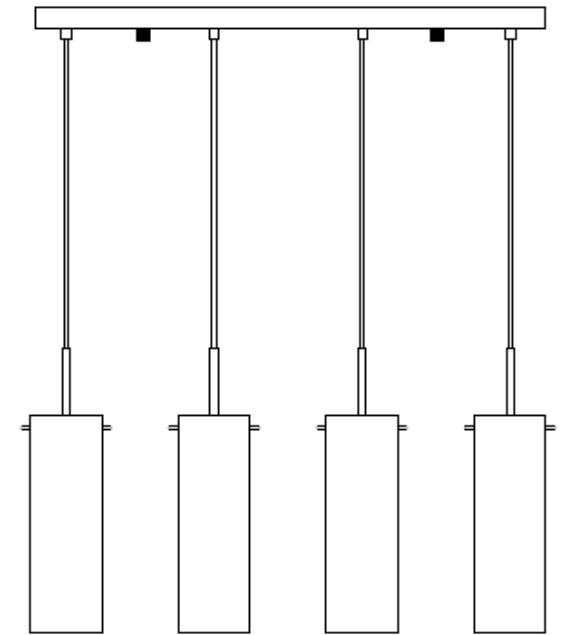

## PREPARATION

Before beginning assembly of product, make sure all parts are present. Compare parts with package contents list and hardware contents list. If any part is missing or damaged, do not attempt to assemble the product.

Estimated Assembly Time: 20 minutes.

If there are any questions relating to defects, missing parts, assembly issues, replacements, or device connectivity issues, please send a detailed email to [cs@jonathany.com](mailto:cs@jonathany.com)

1. Take out ball nut (F) and mounting bracket (D) from canopy (I)
2. Insert the plastic anchors (J) into the wall, fix the mounting bracket (D) to the outlet box with tapping screws (K).  
Fix the mounting bracket (D) to the outlet box with machine screw (E).
3. Make wire connections, with wire connectors (B), following the reference chart listed below.

Connect, Hot, Black or Red Outlet Supply Wire to:	Connect, Neutral, White Outlet Supply Wire to:
Black	White
* Parallel Cord (round & smooth)	* Parallel Cord (square & ridged)
Clear, Brown, Gold or Black without Tracer (colored stripes)	Clear, Brown, Gold or Black with Tracer (colored stripes)
Insulated Wire (not green) with copper metal conductor	Insulated Wire (not green) with Silver metal conductor.

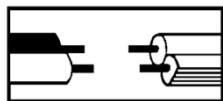

\*Note: When parallel wire ( SPT I & SPT II ) is used. The neutral wire is square shaped and ridged and the hot wire will be round in shape and smooth. ( See Illustration on left. )

### Grounding Instructions:

- a) For installation in the United States: Wrap ground wire from outlet box around green on mounting bracket, no less than 2" from wire end. Tighten ground screw. If fixture is supplied with a ground wire, connect to outlet ground wire with a wire connector.
- b) For installation in Canada: If fixture is supplied with ground wire, wrap ground around green grounding screw on mounting bracket. Tighten ground screw.

4. Fix the canopy (I) with the ball nuts (F).
5. Twist the crystal (O) into the lamp cup (N).
6. The rod through the glass (L), twist the rods (M) into the connectors (P).
7. Use screw driver on fixed connector (A) to adjust the wire.
8. Turn on switch, light up.

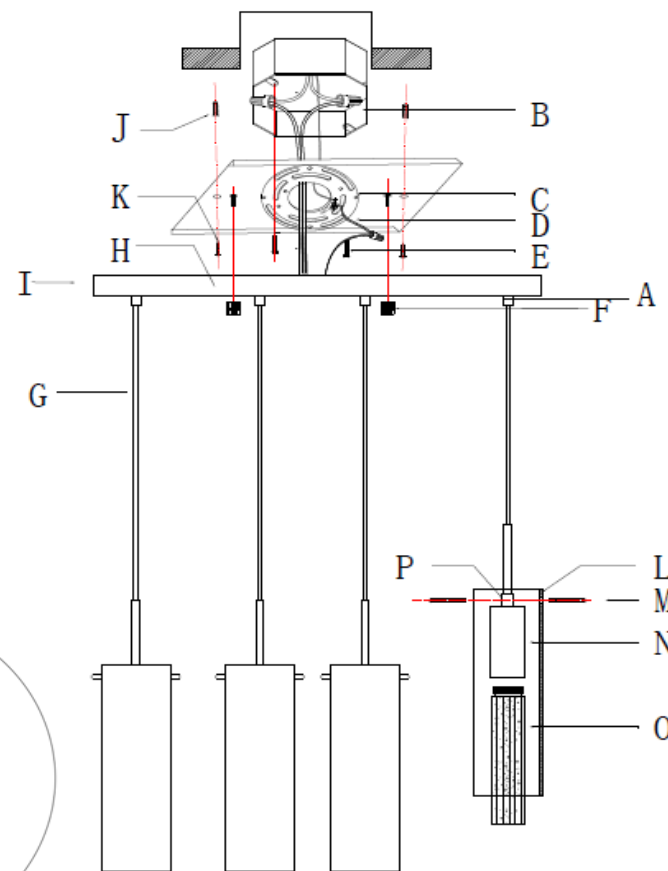
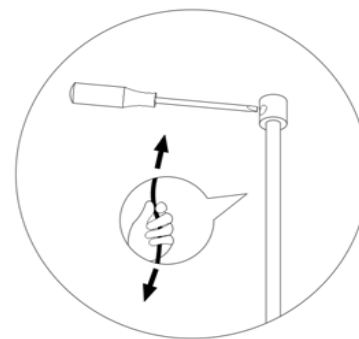

## ENJOY YOUR LAMP

### Compatible Dimmer Model:

Brand	Model No.	Brand	Model No.	Brand	Model No.
Cooper	AAL06	Lutron	CT-600PH	Leviton	6674
Cooper	SAL06P	Leviton	6631-P	Leviton	IPL06
Lutron	TGCL-153P	Leviton	DSM10	Leviton	DSL06
Lutron	CL DVCL-153P-W	Leviton	6672	Leviton	6681-w