

Series	Fusion Workstation
Material	16 Gauge, Type 304 stainless steel
Installation Type	Undermount
Configuration	Single bowl
Finish	Soft satin brushed finish
Overall Dimensions	27" x 18 1/4" x 10"
Bowl Dimensions	25 1/2" x 16" x 9 3/4"
Drain Size	3 1/2"
Finish Available	Stainless Steel
Minimum cabinet size	30"
Template Included	Yes
Clips Included	Yes
Drain Location	Offset
Accessories Included	Strainer, Bottom grid, Cutting board, Book holder and Drying rack

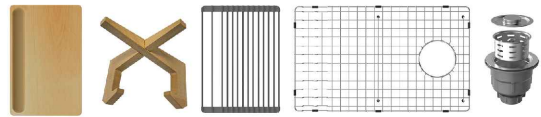

ACCESSORY
Bottom Grid - GR-4006
Strainer - L-3
Drying Rack - DR1712DGR15S
Cutting Board - CB1711BW3CM
Book Holder - RBH1000BW

Stocked Color Options



Stainless Steel

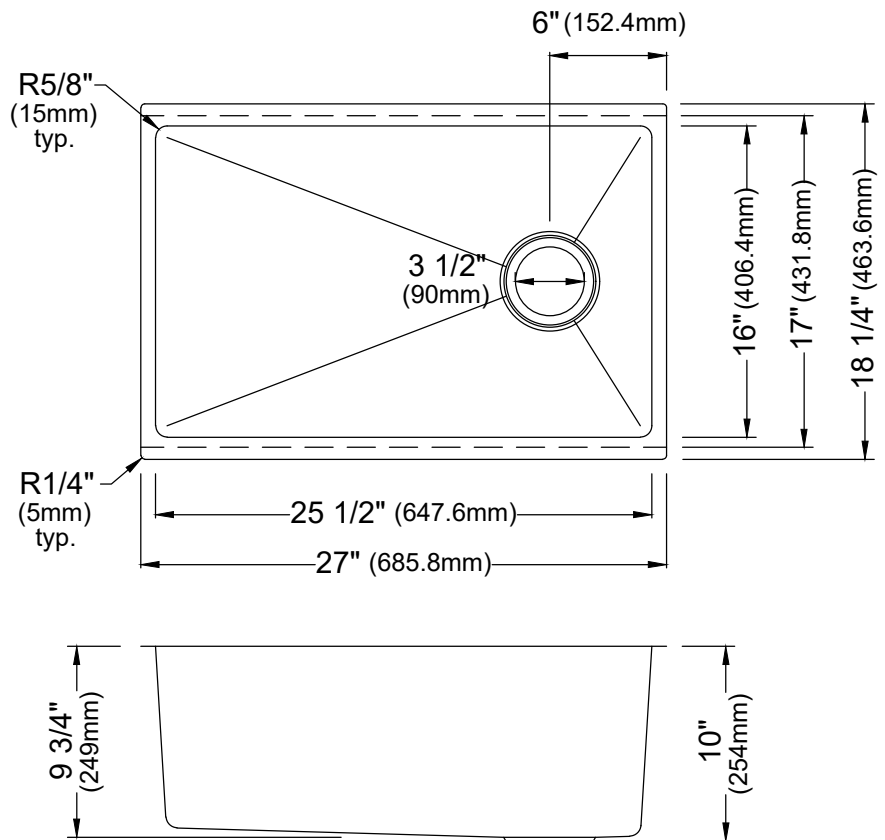

Listing and certifications:  
cUPC

Limited lifetime warranty