

Operating Instructions

CAUTION: You must read this **Operating Instructions** before you proceed.

Ottoman

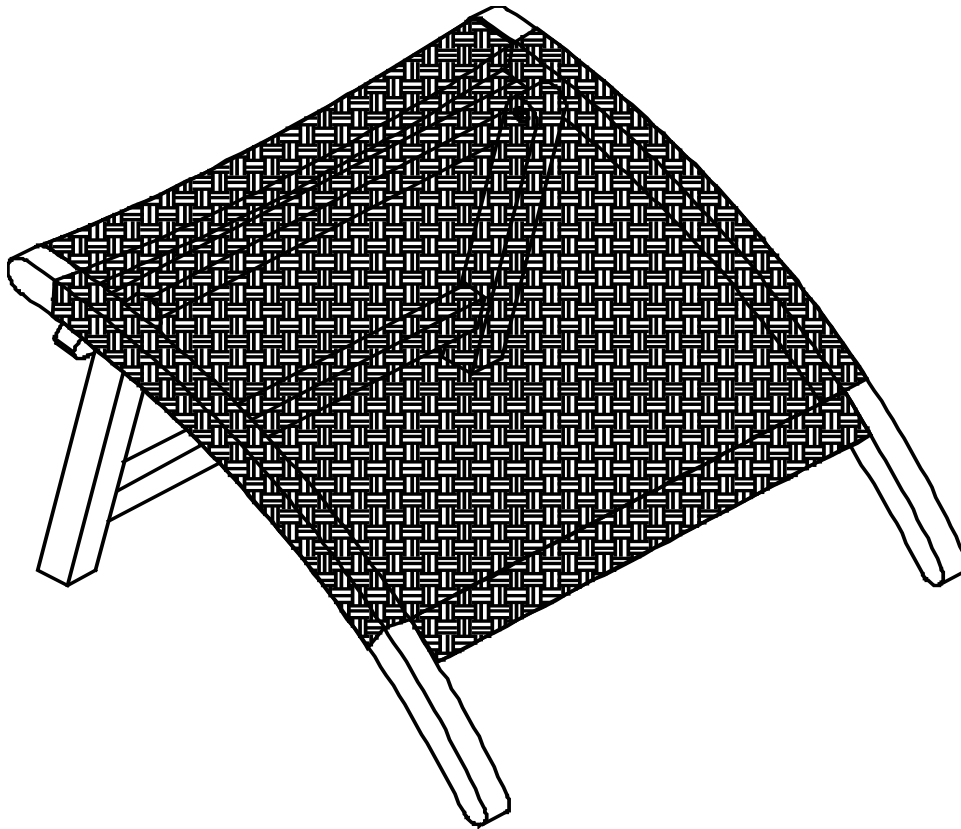

CAUTION: This Ottoman is **NOT** a TOY.
Keep your child / children at bay in when opening of the folding ottoman.
Please **DO NOT** sit on this ottoman.

OPERATING INSTRUCTIONS

Step 1

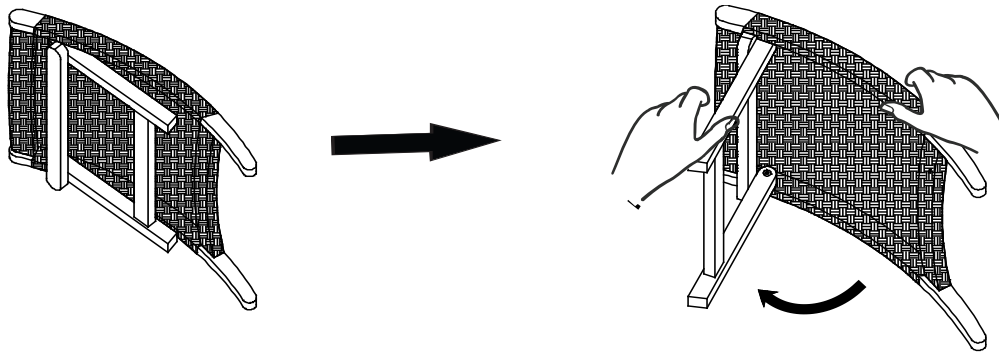

Position the Ottoman as pictured on a clean, non-marring surface.

To open:

Pull the Leg Frame to the left side as indicated by the arrow with one hand and steady the Footrest Frame with your other hand until the Ottoman folds out and locks into position.

Step 2

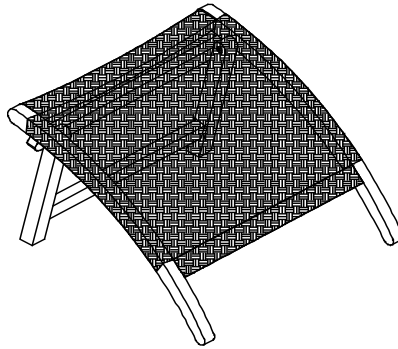

Turn the Ottoman right side up.
Your Ottoman is ready for use.

This Ottoman can only be used on a flat, level surface.

Step 3

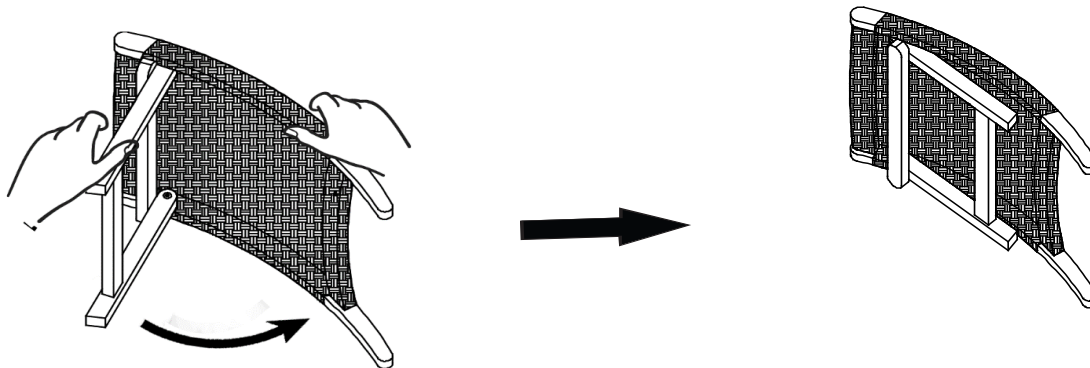











To close:

Turn the Ottoman face down on a clean, non-marring surface.

Pull the Leg Frame towards the Footrest Frame as indicated by the arrow with one hand and steady the Footrest Frame with your other hand until the Ottoman is fully folded up.

Care & Maintenance

-  Do not put hot items directly on furniture surface
 -  Do not clean furniture with harsh cleansers or polish.
 -  To obtain the longest lifespan of your outdoor products, minimizing exposure to direct sunlight is recommended.
 -  Children should not climb or jump on the furniture.
 -  Do not write on furniture without a padded barrier to protect the surface.
 -  To obtain the longest lifespan of your outdoor products, avoid extended and lengthy exposure to rain, snow, and direct sunshine. Whenever possible cover the product and /or place under patio or awnings.
 -  Not for commercial use. For residential use only .
 -  Stains may be removed with mild soap solution and damp cloth.
 -  Keep away from sources of ignition.
-
-  Dust and pick-up spills using a clean, non-colored, lint-free cloth.