

Ceiling Fan
Installation Instruction

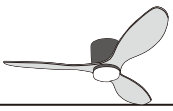

SAFETY INFORMATION

Please read all safety information and instructions before installing the ceiling fan and save this manual for future reference.

SAFETY INFORMATION	01
PRE-INSTALLATION	02
INSTALLATION INSTRUCTION	04
OPERATION INSTRUCTION	08
SPECIFICATIONS	09
TROUBLESHOOTING	10

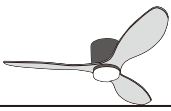

SAFETY INFORMATION



- Before connecting the power supply, make sure that the power supply used matches the specifications of the ceiling fan.
- All wiring must comply with national and local electrical codes ANSI/NFPA70. If you are not familiar with wiring, please use a qualified electrician.
- To reduce the risk of fire or electric shock, turn off the power to the fuse box or circuit breaker before installing the fan.
- To reduce the risk of personal injury, attach the fan directly to the building's support structure and ensure that it can accept at least 35 pounds (15.9 kg).
- Make sure that the installation location allows the fan blades to rotate without obstacles.

Installation Location

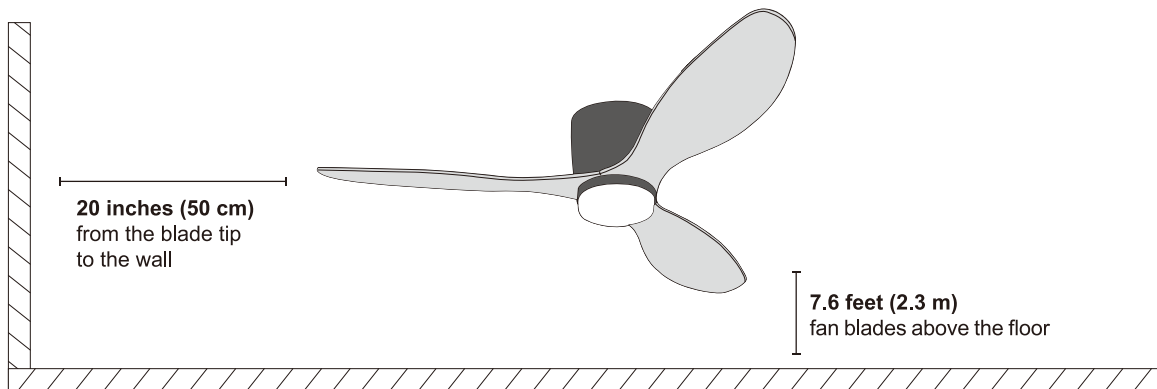

- Do not install the fan with wet hands.
- Do not insert foreign objects between the rotating fan blades.
- Do not bend the fan blades when installing or cleaning the fan.
- Do not disassemble or modify this product or use non-original parts without permission.
- Keep children away from your working area.
- Properly dispose of the fan's packaging material.
- Make sure the ceiling fan is firmly secure to the ceiling. Double check all connections before you restore power.
- Turn off the fan and wait for the blades to stop completely before performing any maintenance or cleaning.

PRE-INSTALLATION

Tools Required (Not Included)



Power Drill

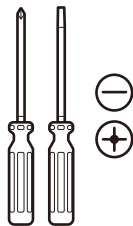

Screwdriver

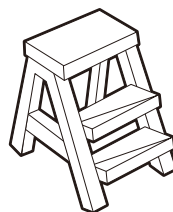

Step Ladder



Wire Stripper

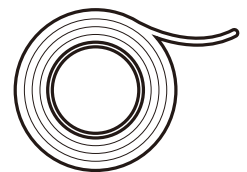

Electrical Tape

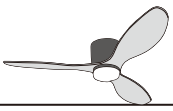

Parts List

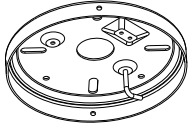

Mounting bracket X1

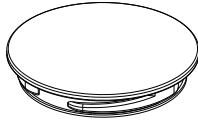

Light Cover X 1

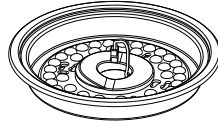

LED & Light Kit Pan X 1

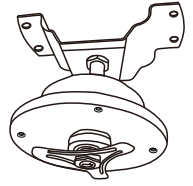

Motor X 1

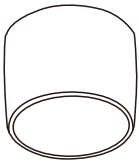

Canopy X 1

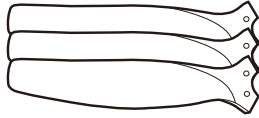

Fan Blade X 3

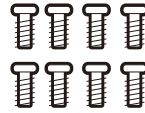

Blade Screw X 8

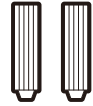

Aircraft Cap X 2

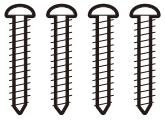

Self-tapping Screw X 4

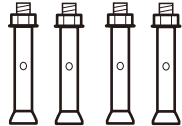

Expansion Bolt X4

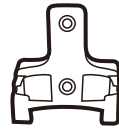

Remote Control Bracket X 1



Remote Bracket Screw X 2

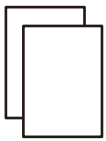

Balance Kit X 2



Wire Caps Screw Terminals X 3



Remote Control X 1

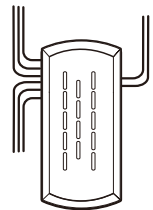

Receiver X 1

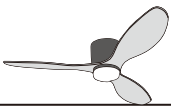

INSTALLATION INSTRUCTION

Step 1: Mounting Bracket Installation

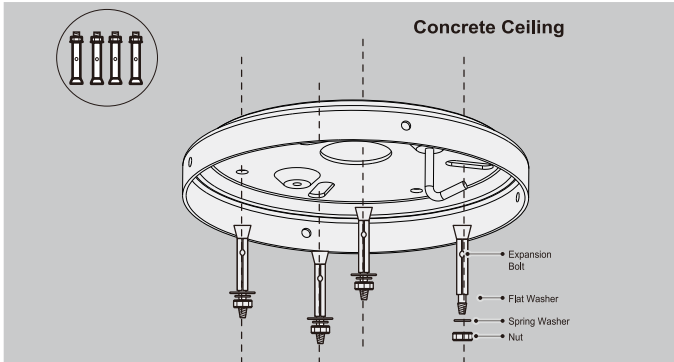

1. Drill holes with electric drill ($\phi 8$ mm).
2. Use expansion screws to fix the mounting bracket to the ceiling.

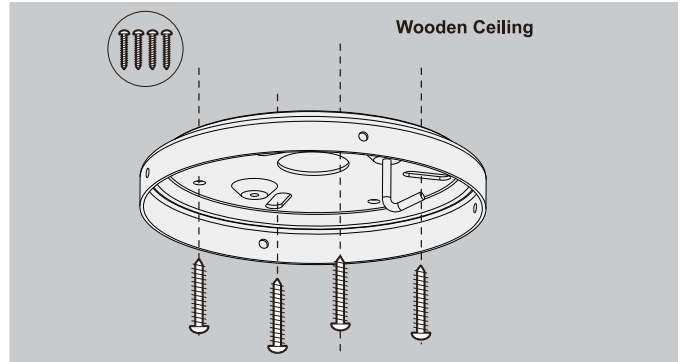

Fasten the mounting bracket to the ceiling with self-tapping screws.

Step 2: Fan Blade Installation

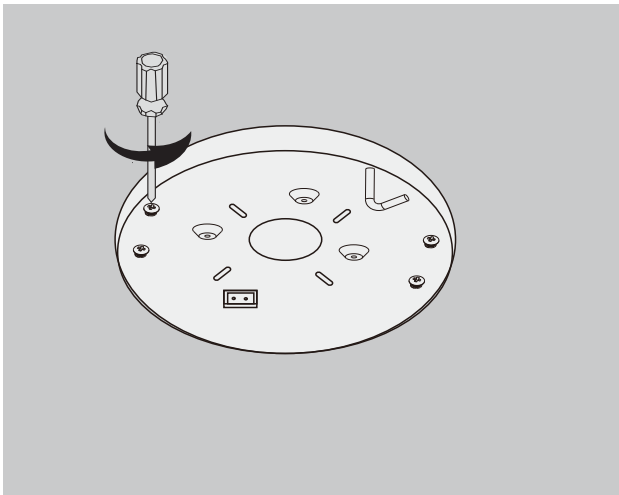

- 1 Loosen the four screws on the butterfly hook.

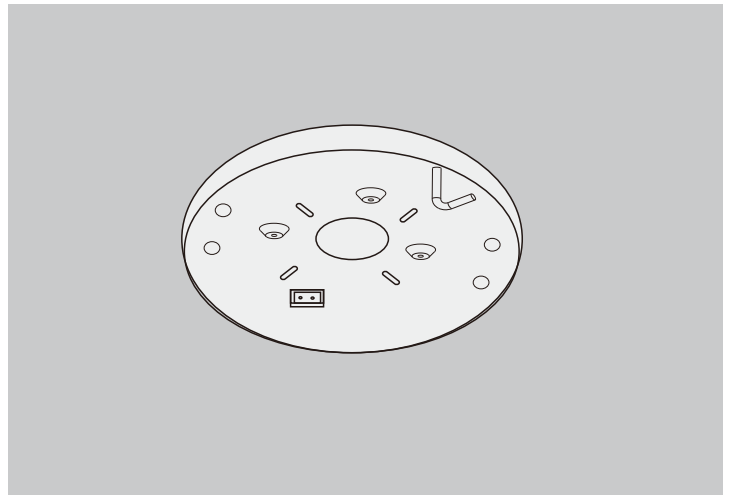

- 2 Align the three holes on the canopy with the main body of the motor and secure in place

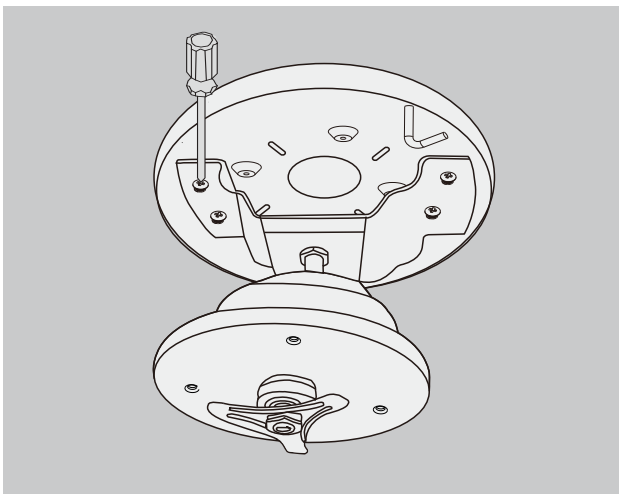

- 1 Align the holes on the bracket with the holes on the hanging disc and tighten the screws.

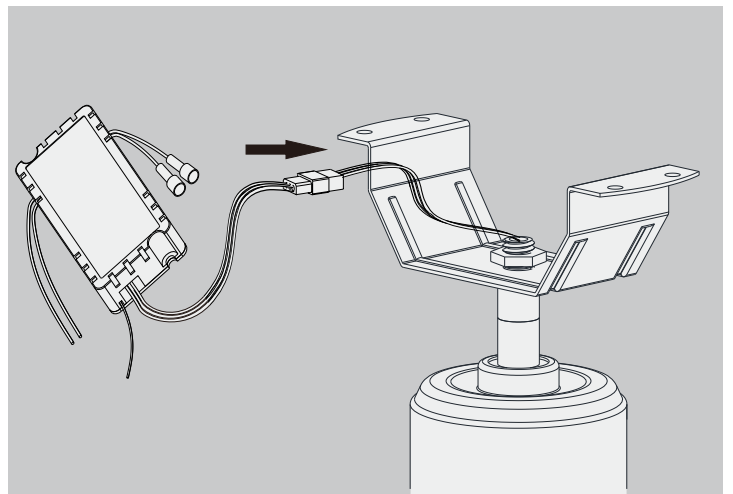

- 2 Connect the wires properly, install the receiver and place the receiver on the bracket.

Note:

- The fan blade needs to be aligned with the "center" position of the screw hole group.
- Do not lock the screws when installing the blades and then tighten all the screws after all the fan blades are installed.

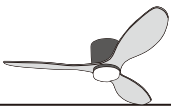

Step 3: Wiring Instruction

⚠ Shut off the power to the fuse box or circuit breaker before wiring.

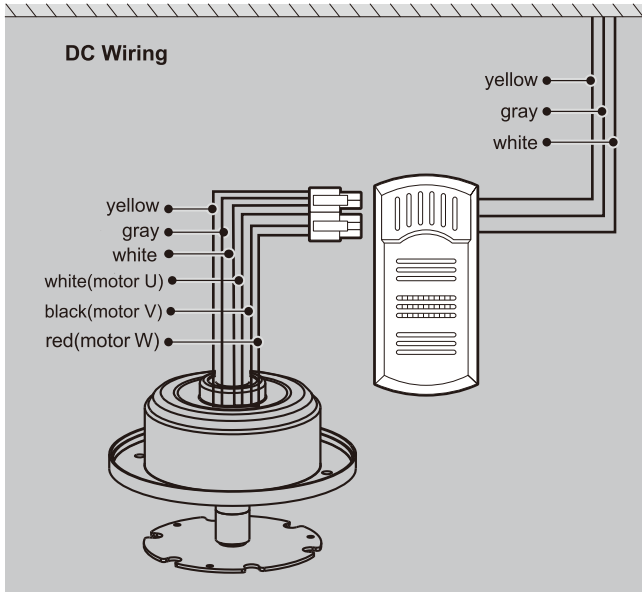

Step 4: Installation of the Motor Cover

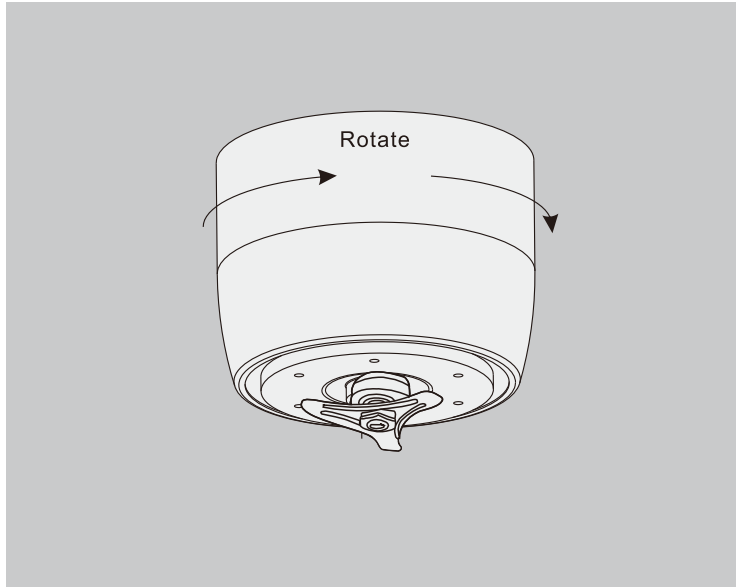

1 The receiver is connected to the motor power cord and the ceiling power cord respectively.

2 Align the slots on the motor with the slots on the hanging disc and then rotate and tighten them.

Note:

Connect wires color to color, plug to plug.



Live Wire



Neutral Wire



Ground Wire

Step 5: Blades installation

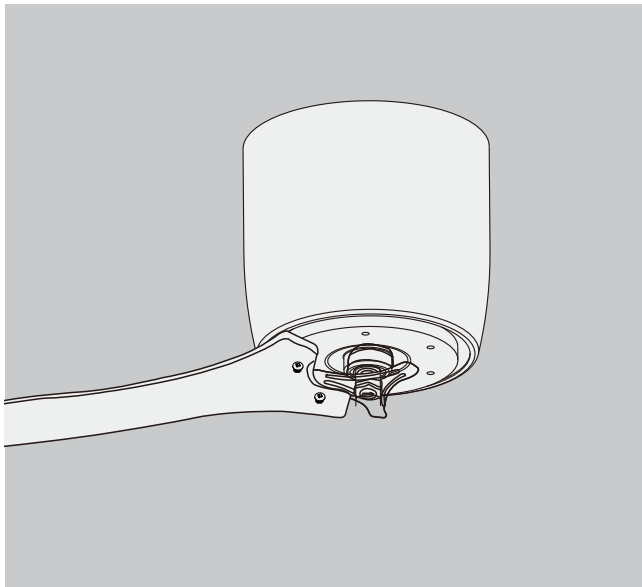

1 Clamp the fan blade under the triangular cover and fix the fan blade to the motor with screws and gaskets.

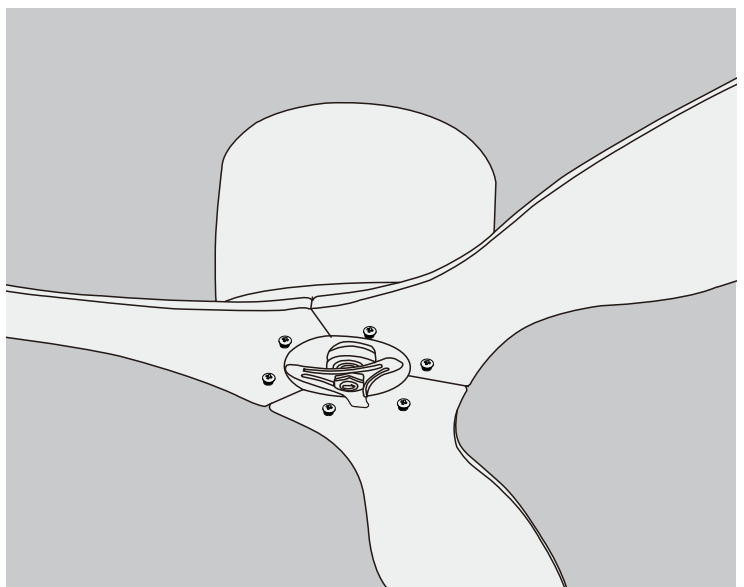

2 Install the three fan blades one by one and fix them with screws.

Note:

• The fan blade needs to be aligned with the "center" position of the screw hole group.

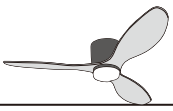

Step 6: Installation of LED Board

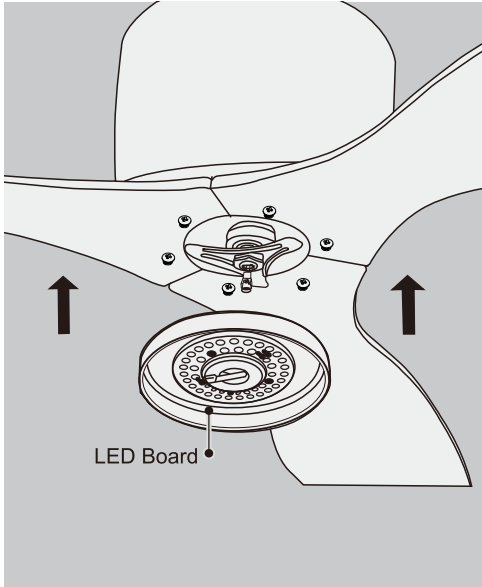

- 3 Thread the motor line through the LED board, then align the LED board with the triangular cover on the motor and put it on.

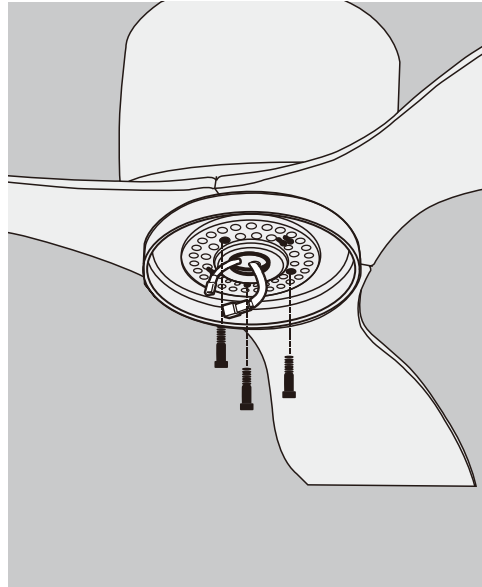

- 4 Install the screws on the triangular cover into the corresponding holes.

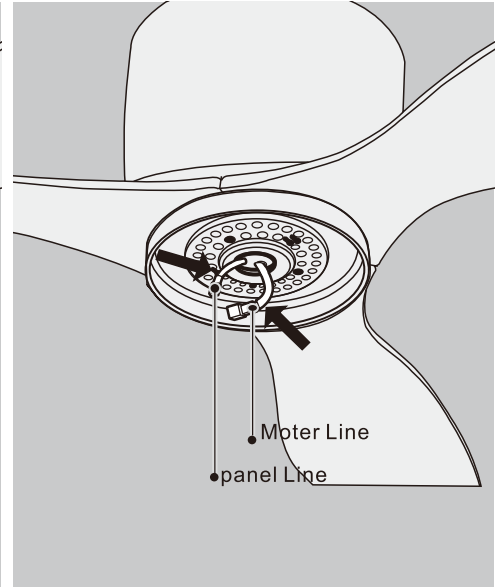

- 5 Connect the motor line and the lamp panel line.

Step 7: Install the Lampshade

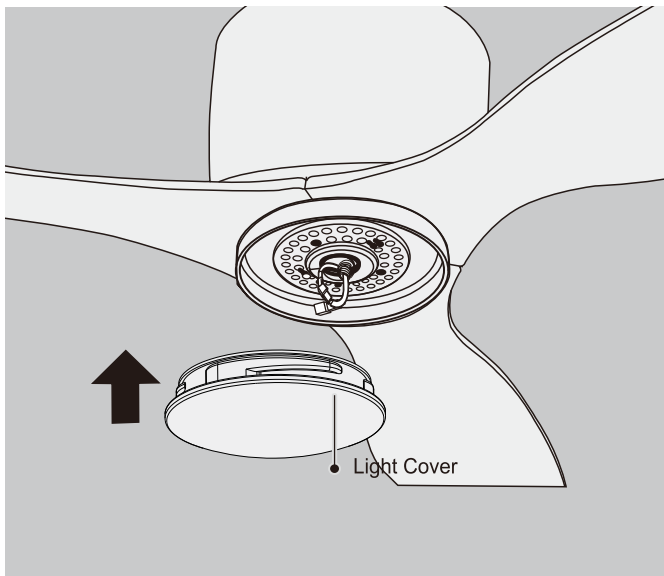

- 1 Put the light cover to the LED board.

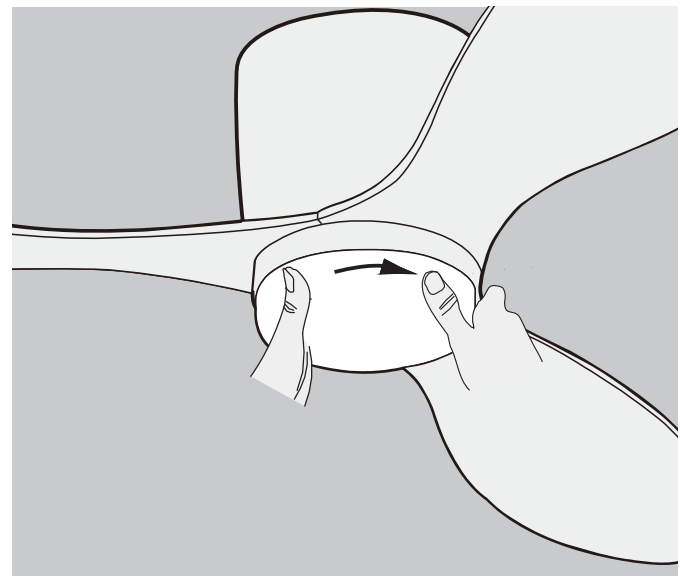

- 2 Spin forward to tighten the light cover.

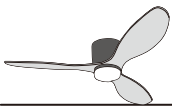

OPERATION INSTRUCTION

Control Method

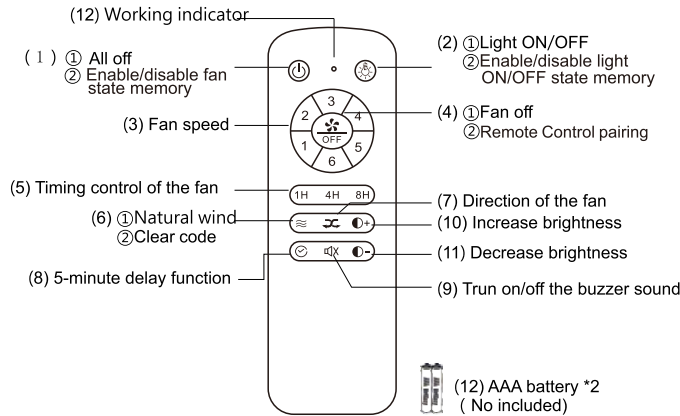

The remote controller only needs to be paired once. After the paired product, the controller will have memory. The products have been paired before leaving the factory. When the remote control is damaged or lost, it is necessary to implement remote control pairing before using a new remote control.

- (1) **All OFF:**
 - ⊙ Turn OFF the Fan and Light together.
 - ⊙ Long press: press and hold the key for 2-3 seconds. A long press produces a long beep to activate the memory function for the fan's state before power-off. A long pressing again will produce two short beeps to deactivate the memory function.
 - (2) **Light ON/OFF:**
 - ⊙ Press the key to turn on or turn off the light.
 - ⊙ Long press: press and hold the key for 2-3 seconds. A long press produces a long beep to activate the memory function for the light's state (on or off) before power-off. A long pressing again will produce two short beeps to deactivate the memory function. (Just remember the state (on or off) of the light, not the light's color temperature)
 - (3) **Fan speed:**
 - ⊙ Press keys 1-6 to adjust the fan speed.
 - (4) **Fan OFF/Remote control pairing:**
 - ⊙ Turn OFF the Fan.
 - ⊙ For remote control pairing, press and hold the button for 3-5 seconds within 30 seconds of powering on. The buzzer will emit a long beep to confirm that pairing is complete.
- Note: The remote controller only needs to be paired once. After pairing, it will retain memory. Products are pre-paired at the factory. If the remote control is damaged or lost, pairing with a new remote control is necessary before use.
- (5) **Timing control of the Fan:**
 - ⊙ Press the 1H/4H/8H keys to set the fan timer for 1, 4, or 8 hours. The fan will automatically turn off when the timer ends. During the timing function, all functions of the ceiling fan can be operated. To cancel the timer setting, press key (1) or key (7) while the timing function is active.
 - (6) **Natural wind:**
 - ⊙ Press the key to activate the natural wind mode, which automatically adjusts the fan speed between levels 1 and 6.
 - ⊙ Press and hold this button until a long beep is heard to clear the code. Then, press and hold the "FAN OFF" button to re-pair and restore the program to factory settings.
 - (7) **Direction of the fan:**
 - ⊙ Change the direction of the fan using the appropriate controls.
 - (8) **5-minute delay function:**
 - ⊙ Press the key to activate the 5-minute delay function for the light, after which it will automatically turn off.
- Note: After the delay, the fan remains unchanged. This function is primarily for pre-sleep lighting delays. If used before leaving, you'll need to manually turn off the fan with "FAN OFF".
- (9) **Turn ON/OFF the buzzer sound:**
 - ⊙ Press the key to toggle the buzzer sound on or off.
 - (10) **Increase brightness:**
 - ⊙ Press the key to increase brightness.
 - (11) **Decrease brightness:**
 - ⊙ Press the key to decrease brightness.

AAA battery (2):

- ⊙ Install 2 AAA batteries before use.
- ⊙ Remove the batteries when not in use for an extended period.

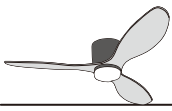

Reversible Function

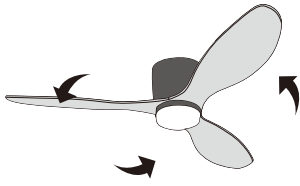

Summer (Forward):
A downward airflow creates a cooling effect.

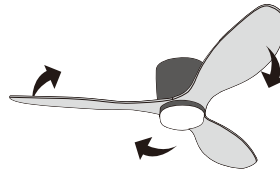

Winter (Reverse):
An upward airflow increases the indoor temperature.

PS: If you want to change the fan's rotation direction, please press the button while the fan is running.

Timing Control

1H: The fan will automatically shut off after 1 hour.

4H: The fan will automatically shut off after 4 hours.

8H: The fan will automatically shut off after 8 hours.

Close the Timing Control: Press the button "FAN ON/OFF"

Memory function of LED light color temperature.

Our LED Light comes with a color temperature memory function. If the light is turned off for less than 7 seconds and then turned on again, it will switch to the next color temperature. If the light is turned off for more than 7 seconds and then turned on again, it will remember the color temperature from before it was turned off.

Note: The LED light may not correspond with the image. Please refer to the actual product.

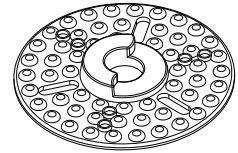

SPECIFICATIONS

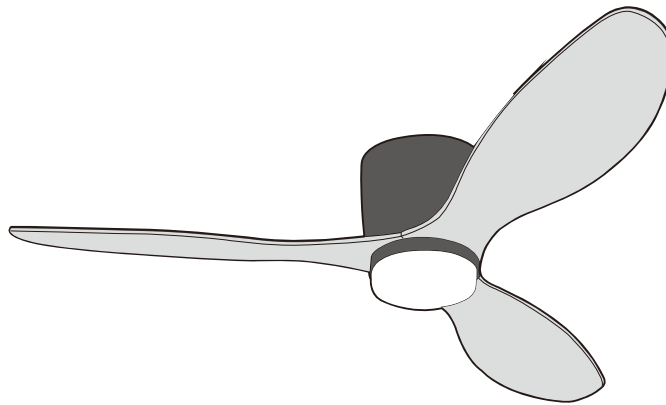

Product Name	Ceiling Fan	Size	42" / 52"
Rated Voltage	110V-265V	Motor Spec	Φ140*10
Lamp configuration	20W LED	Overall height	280mm
Lampshade size	Φ 180 mm	Fan blade	3 ABS fan blades
control method	Remote Control		

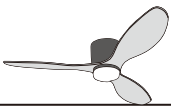

TROUBLE SHOOTING

If there is a problem with the fan during use, please check the following tips for solutions. If the problem still cannot be solved, please contact our after-sales team.

The Fan Does Not Respond to the Remote Control.

- Check that all wire connections are correct and secure.
- Verify that the power is turned on and reaching the receiver.
- Verify that the batteries of the remote control are installed with the correct polarity, making sure to install the + (positive) end of the batteries on the solid end and the - (negative) end on the spring.

The Fan Makes a Humming Noise.

- Make sure the controls you use are supplied with your fan.
- Make sure all accessories are securely fastened. Loose parts often cause a vibrating noise or buzzing sound.
- Disassemble the fan and reinstalling it can sometimes remedy this resonant vibrating noise.

The Fan Makes a Repetitive Ticking Noise.

- Check for obstructions in the rotor path.
- Make sure mounting hardware at the ceiling is firmly fasten.
- Make sure all other hardware and blade attachments are tight.
- Give the fan a "Break in Period" of a few hours to a few days, then repeat the steps above.

The Fan Wobbles.

- Make sure the mounting plate and hardware at the ceiling are firmly fastened.
- Make sure all screw fittings on the fan are tight.
- If necessary, use the self-tapping screws provided to further secure the bracket to the joist.

Warning sound.

- In the case of a motor fault, a buzzer is typically used to emit a warning sound. When the motor lacks a phase, meaning that one of the phases is not functioning properly, the buzzer will emit a continuous single beep as a warning. This indicates that the motor is unable to operate correctly.
- If the motor gets stuck and cannot rotate, the buzzer will emit a continuous double beep as a warning. These warning sounds are intended to alert users to the abnormal conditions of the motor and prompt them to perform necessary repairs or inspections.

About light' color temperature

The remote control's light memory function can only remember the light's on/off state, not the color temperature. Therefore, we have added a program to remember the light's color temperature in the LED light itself. You can select/remember the light's color temperature by using the "light on/off" switch on the remote control. When you turn the light on and then off, the program will record the time of turning off. If the light is turned off for less than 7 seconds, when you turn it on again, the light will switch to the next color temperature. If the light is turned off for more than 7 seconds, when you turn it on again, the light will remember the last color temperature used. This program is designed this way because most people tend to use a specific color temperature continuously until they no longer need it and turn it off, which usually takes more than 7 seconds.

It is normal for some LED light to require to be turned off for more than 30 seconds to remember the last color temperature used. The exact time required for the light source to remember the last color temperature may vary depending on the specific light source and its programming. However, the default time of 7 seconds for remembering the last color temperature used is suitable for most LED lights.

CONTACT INFORMATION

We want to hear your voice! Feel free to touch base if you encounter any issue when using our product(s) or want to know more about our brand.

We will be more than happy to provide top-notch pre-sales & after-sales service 24/7.

Contact us through Amazon:

- 1.Go to Your Orders.
- 2.Find your order in the list.
- 3.Select Problem with order.
- 4.Choose your topic from list displayed.
- 5.Select Contact seller.