

30-IN WALL CABINET 2 DOORS

CAISSON DE HAUT 30-PO. 2 PORTES

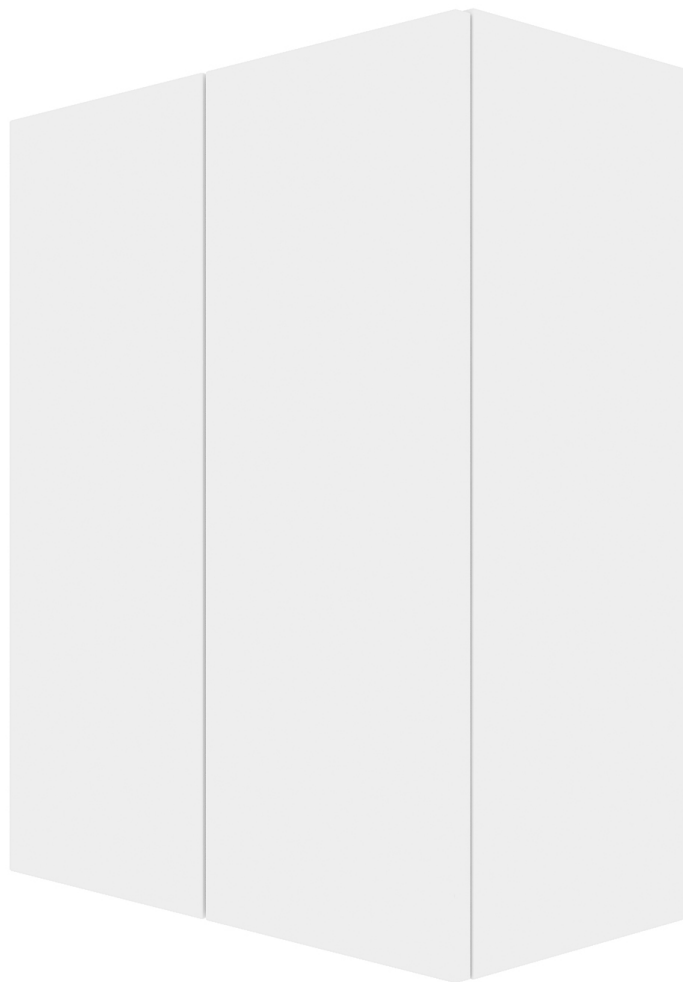

Assembly Instructions
Instructions d'assemblage



Z00200



x16

Z00210



x8

Z00209



x8

Z01561



x4

Z01558



x4

Z01361



x8

Z01362



x4

Z00200



x16

CQ-CHIG-BL



x2

CQ-DS030-FBL

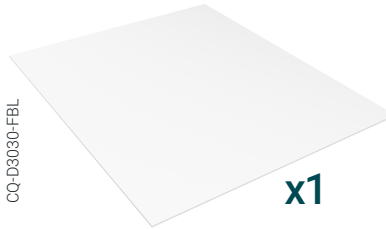

x1

CQ-BH30-BL



x2

CQ-DD30-BL



x2

CQ-TH30-BL



x2

Door models

Modèles de portes

CQ1530-MEL-BL

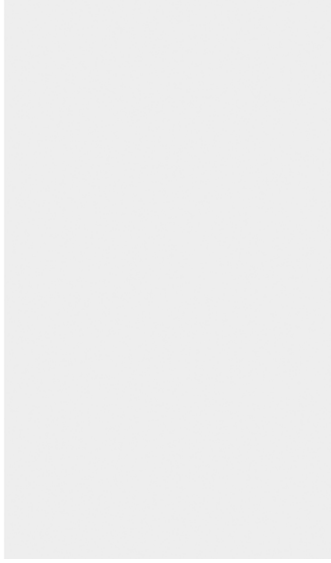

CQ1530-ST-BLM

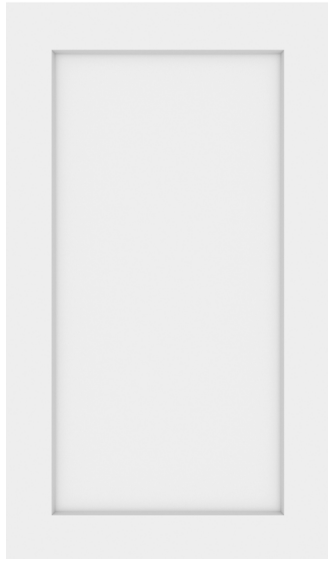

CQ1530-ST-GRM



CQ1530-MEL-FEY



CQ1530-PA-NOM

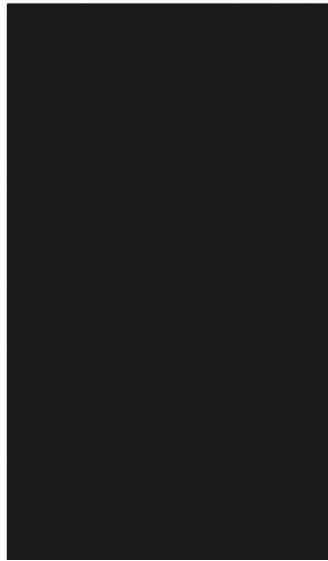

1

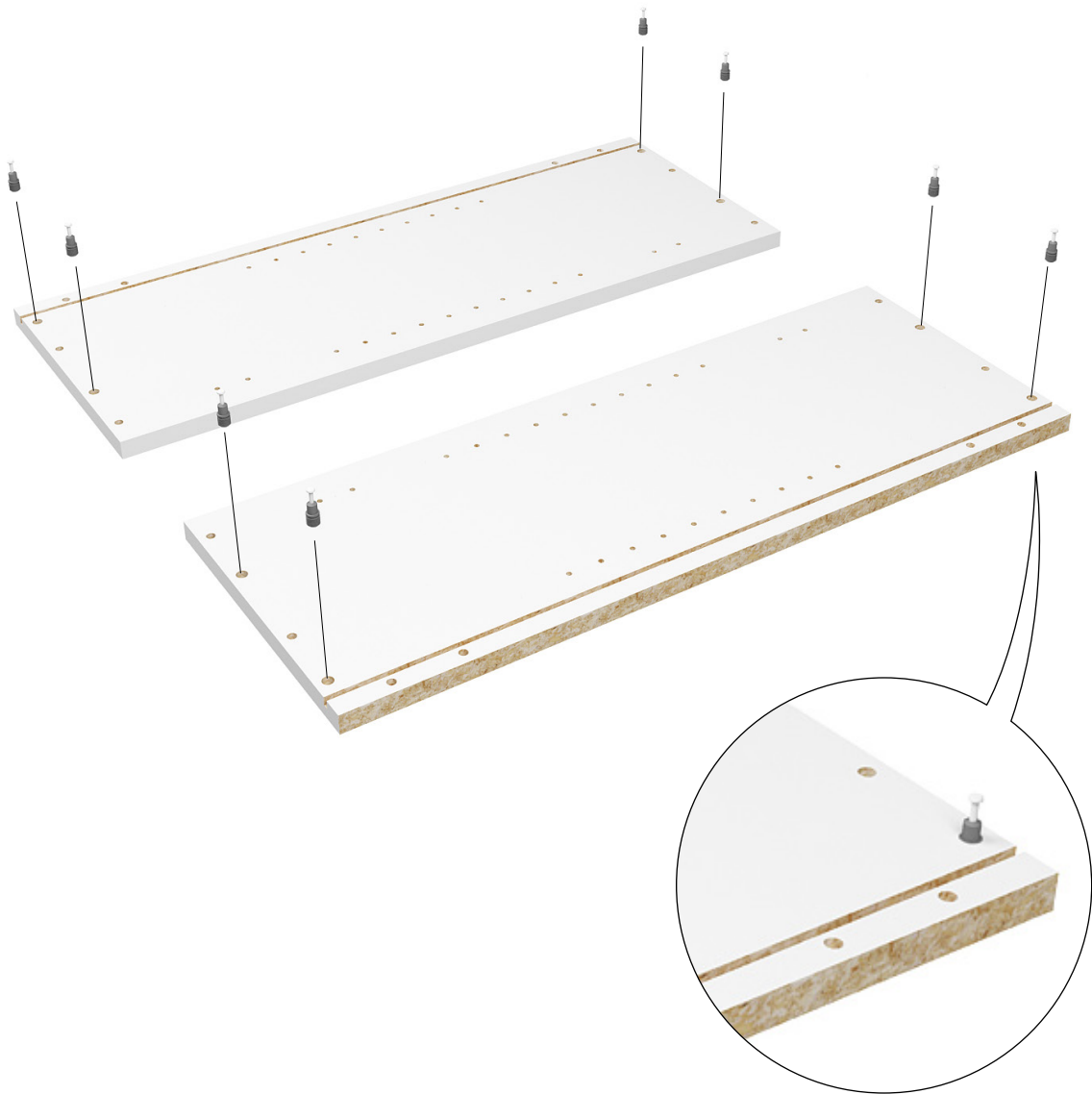
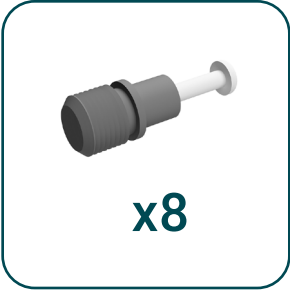
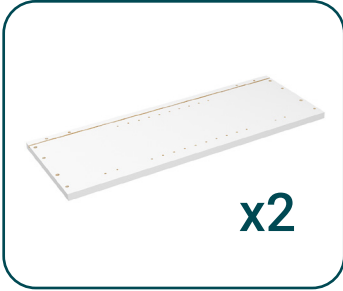

2

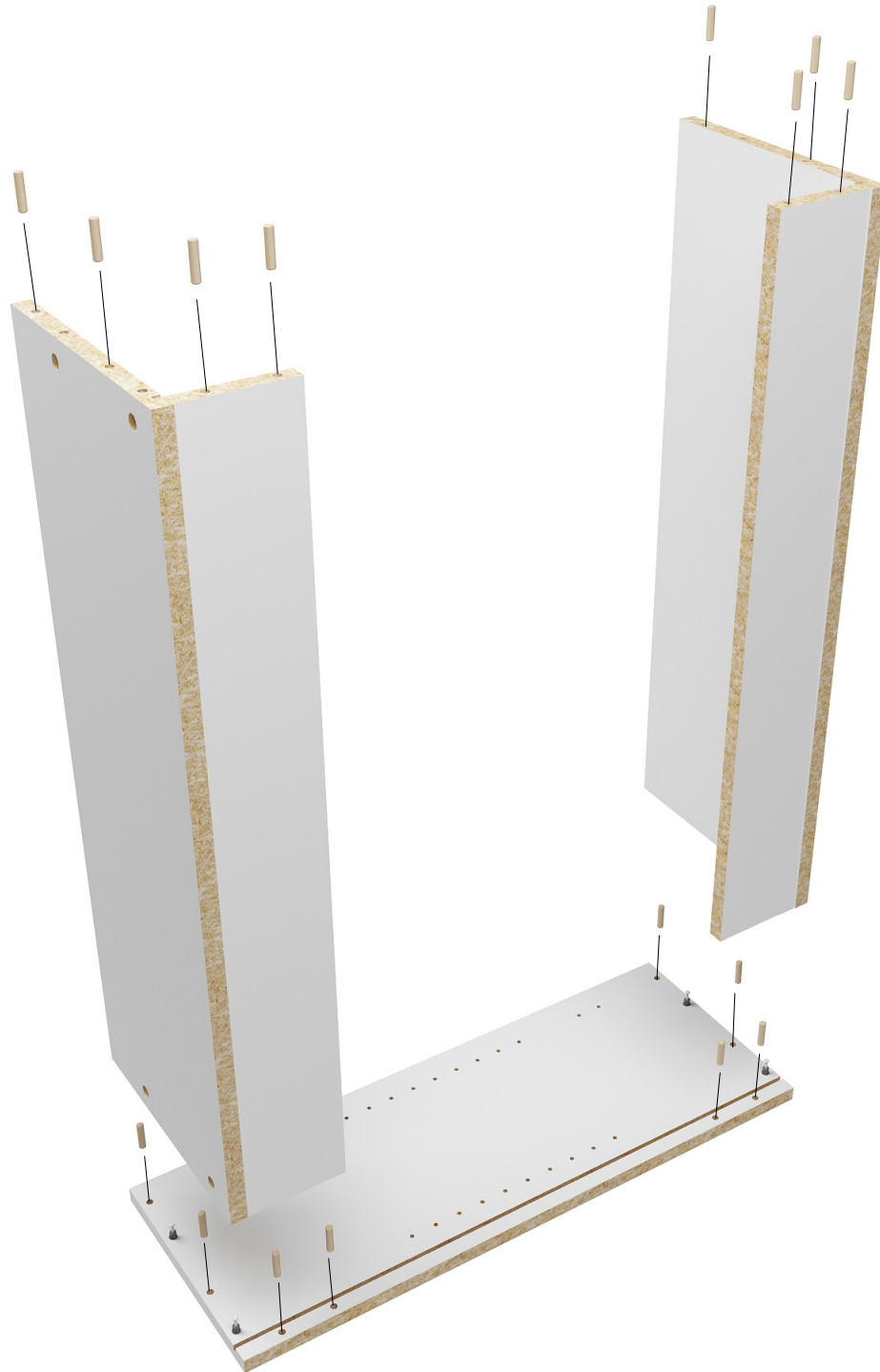
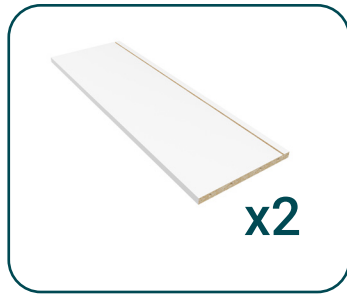

3

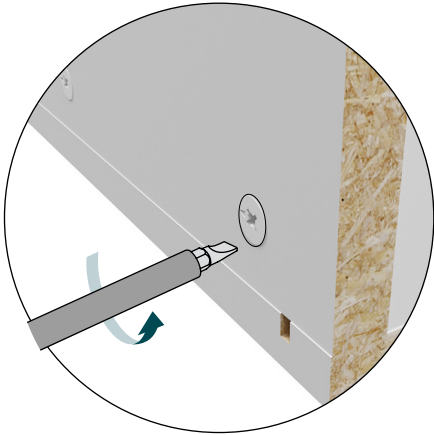
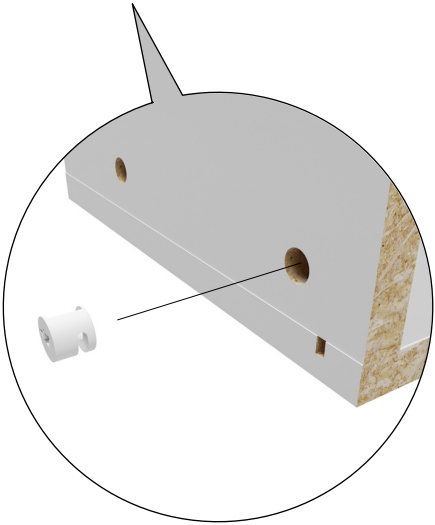
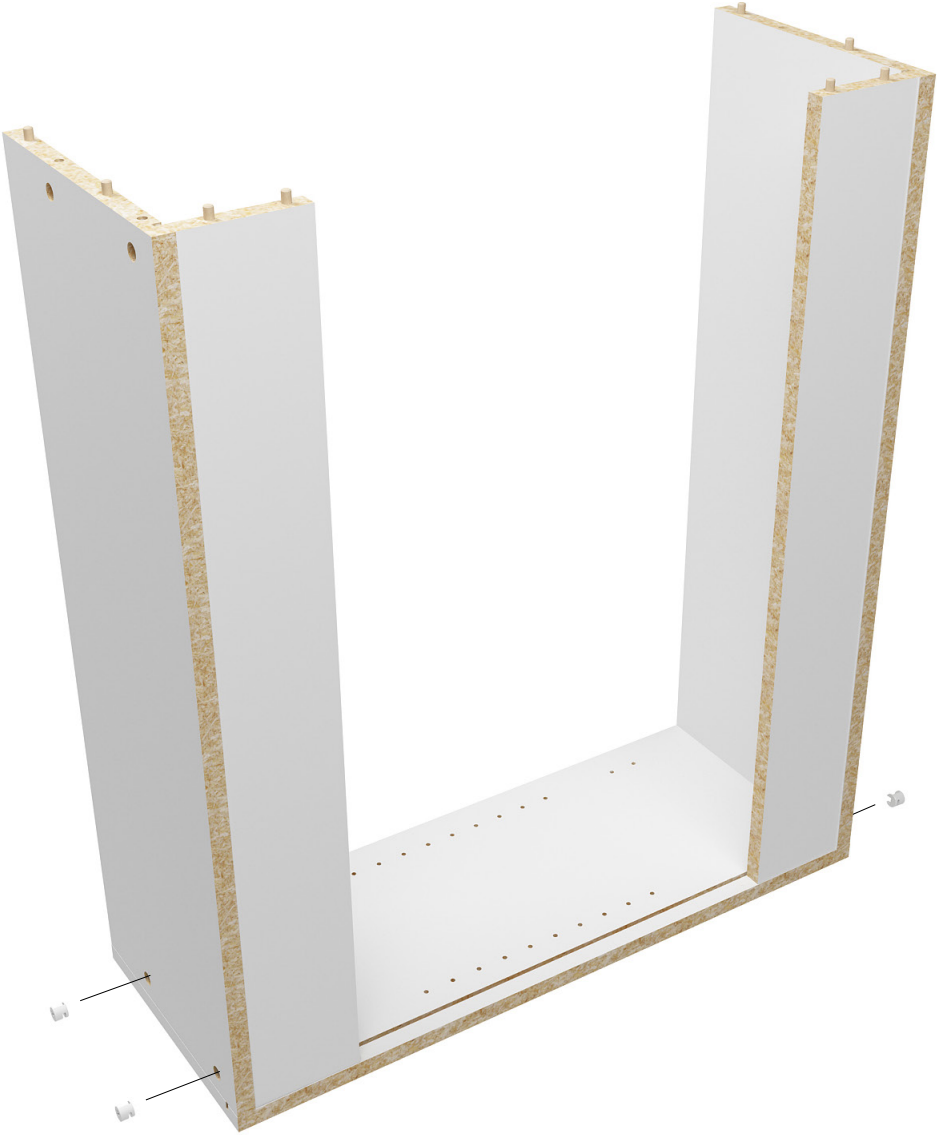
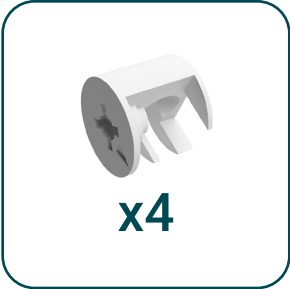

4

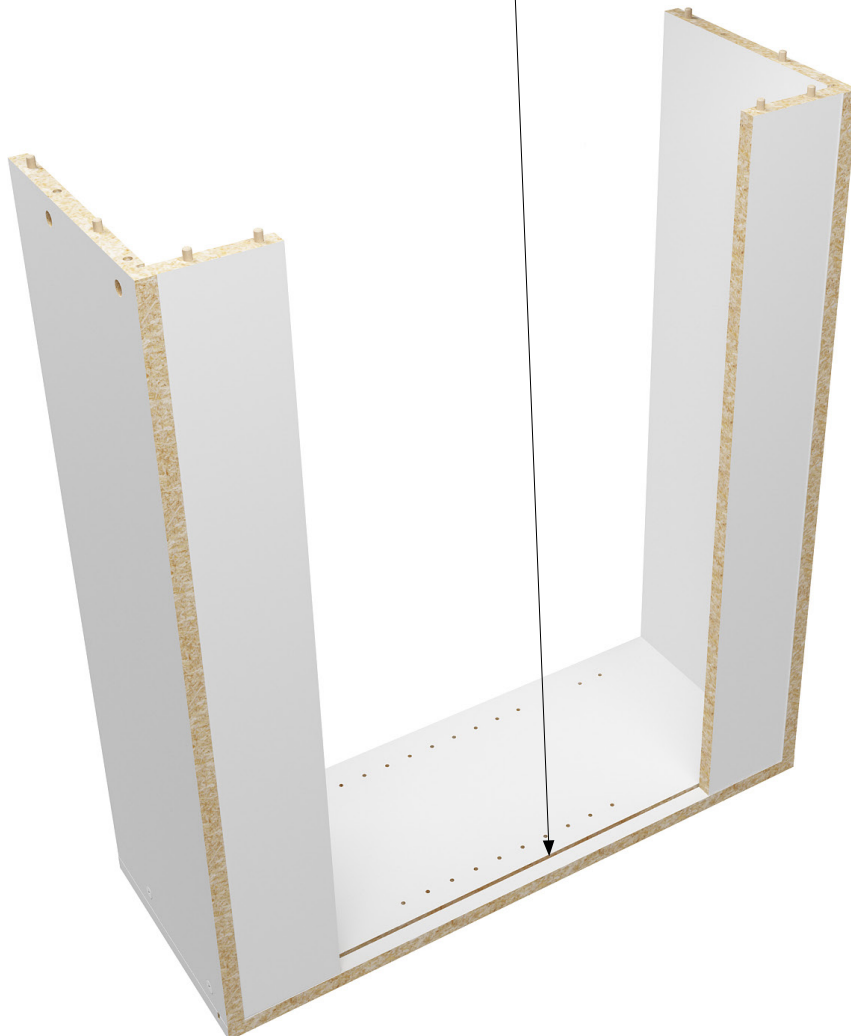
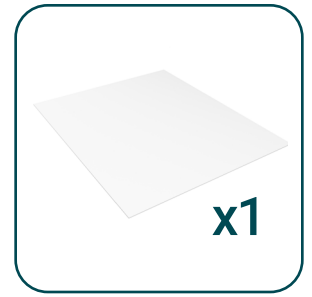

5

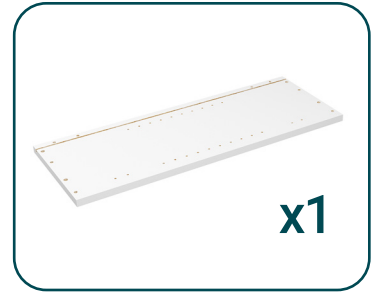

6

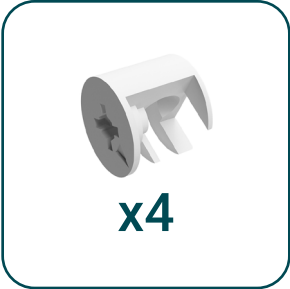

7

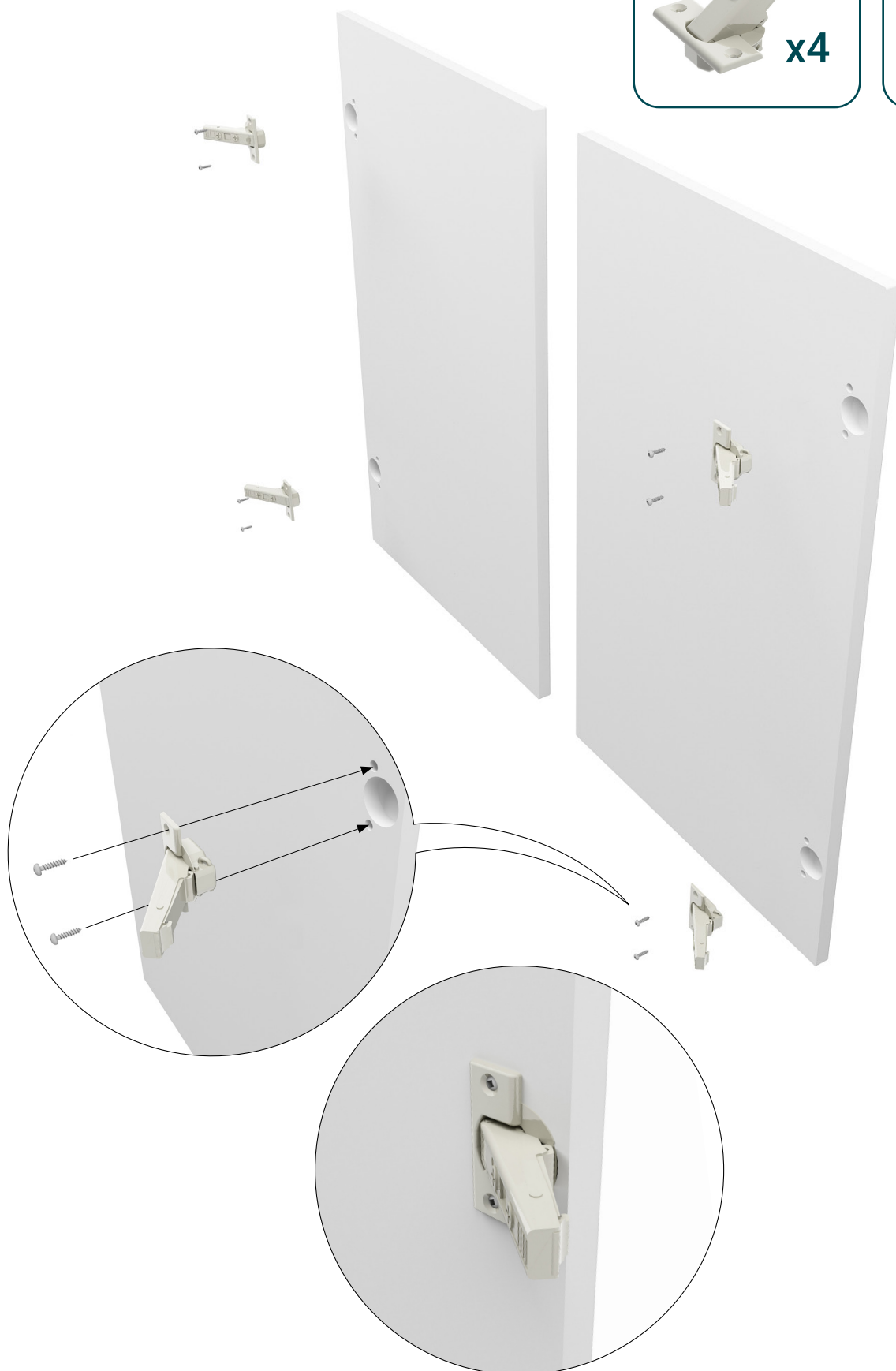
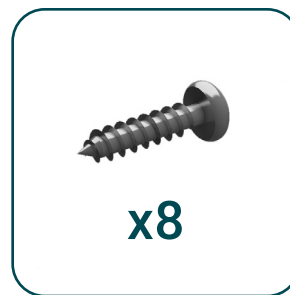

8

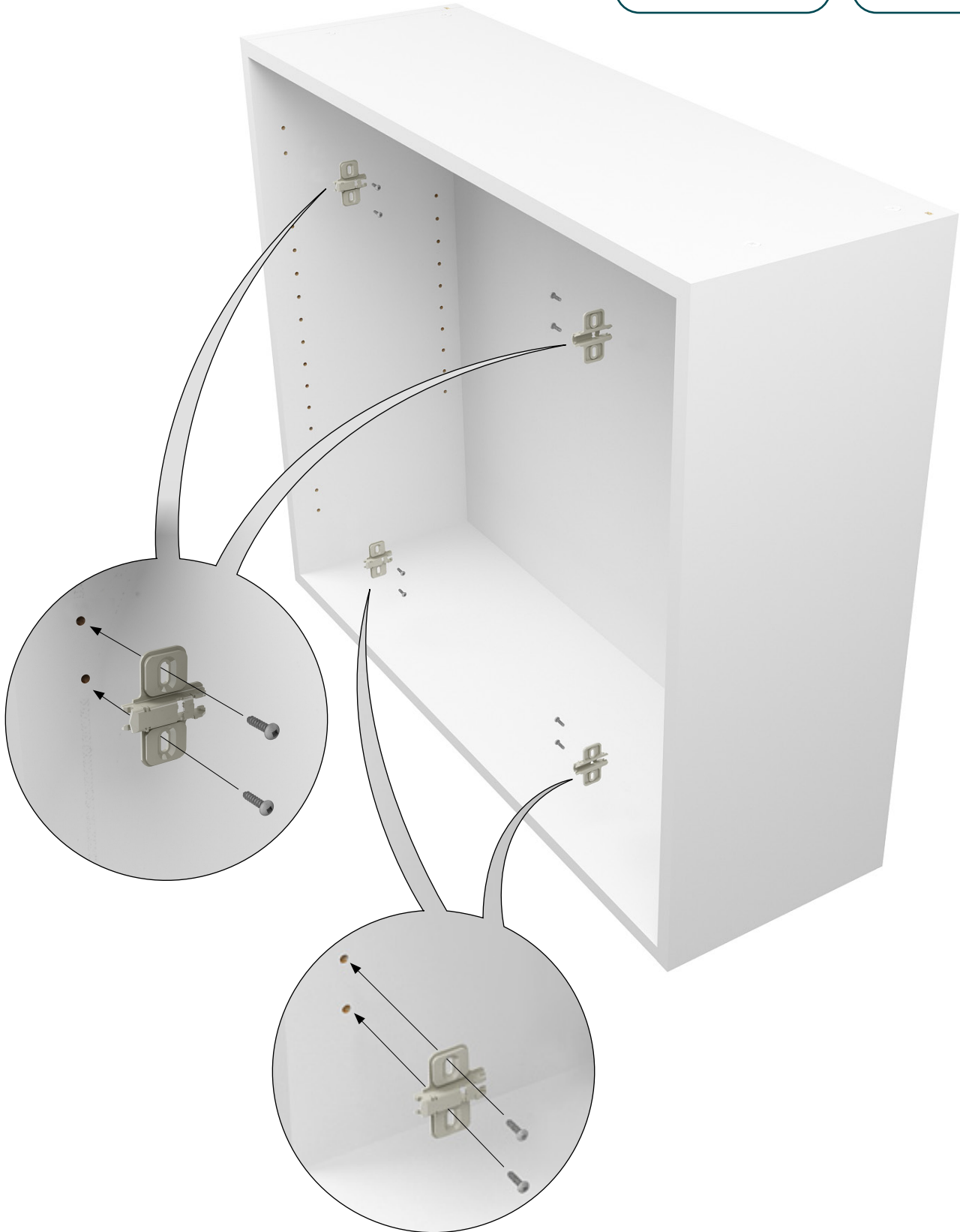
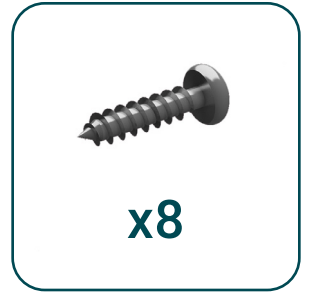

9



10

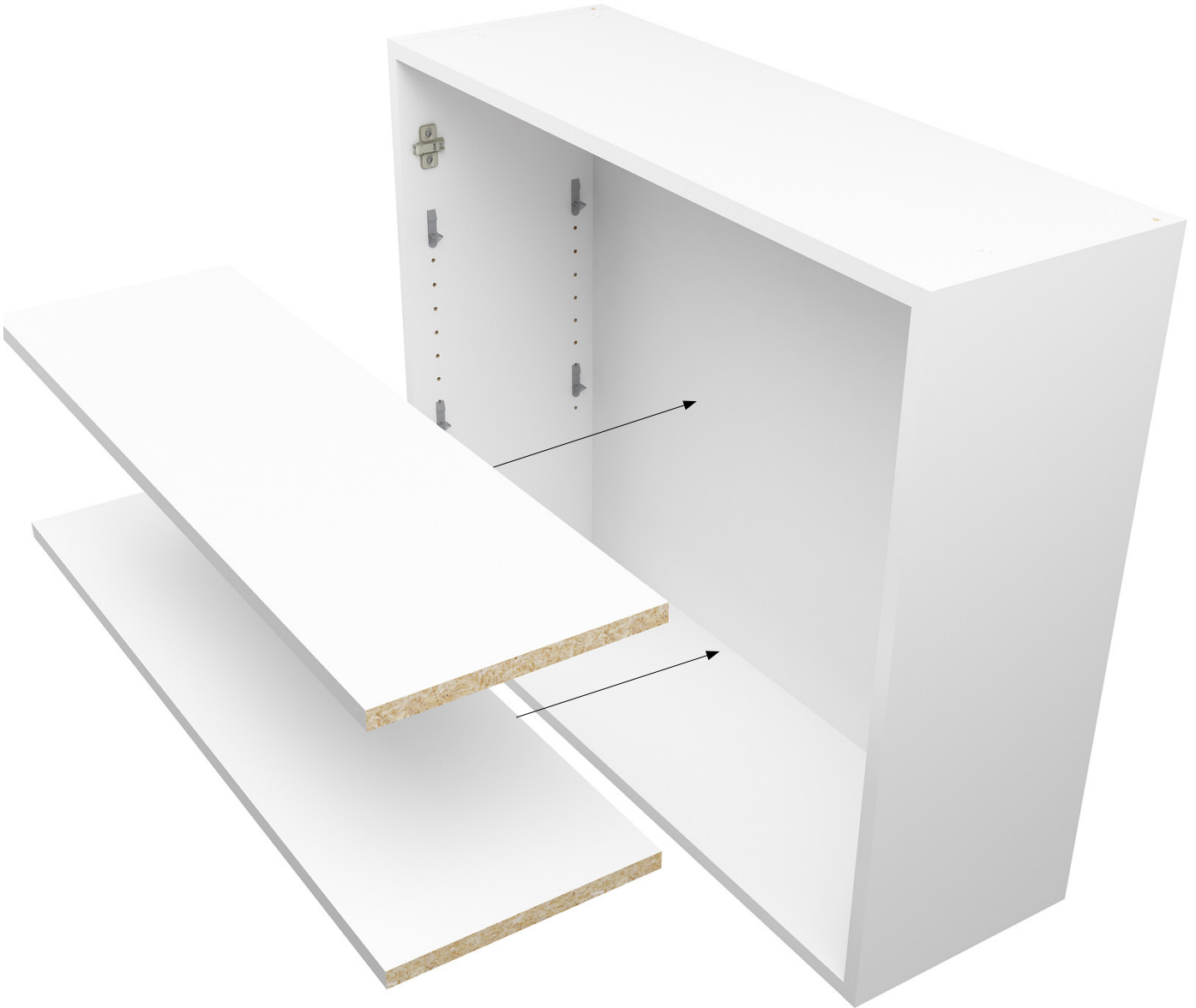
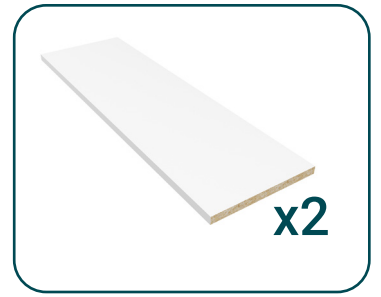

11



12



CONTACT US
CONTACTEZ-NOUS
EKLIPSE@EBSU.CA
1 877-533-7729

