

Faucet maintenance

1. Do not disassemble the faucet parts without authorization.
2. Cleaning faucet: wipe with a soft towel or rag after wetting. Do not use hard and sharp cleaning tools to clean the faucet to avoid scratching the plating layer.
3. Avoid contact with corrosive liquids such as strong acids and alkalis.
4. Please contact us if you encounter any problems during installation and use. We will try to provide you with effective solutions within 12 hours.

POT FILLER FAUCET INSTALLATION INSTRUCTION

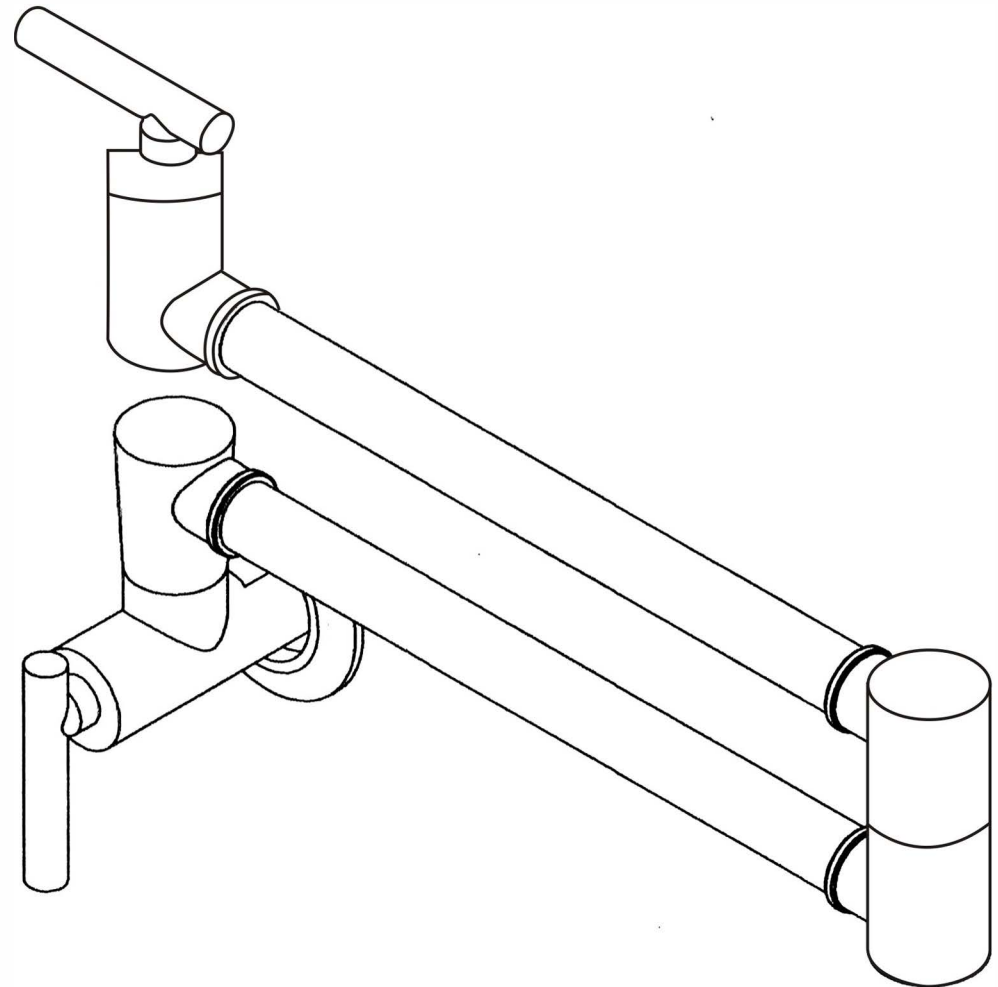

Thank you for choosing our Pot Filler Faucet

Please read the product manual carefully before installation

Please keep the box and packaging materials until your product is completely installed.

If you have any questions, require technical assistance, or have any problems with your product, please contact our Customer Service Team.

Please provide Amazon's order number to communicate with us.

We will reply to your message as soon as possible.

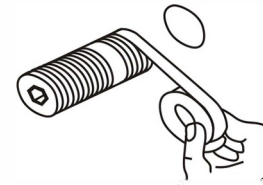
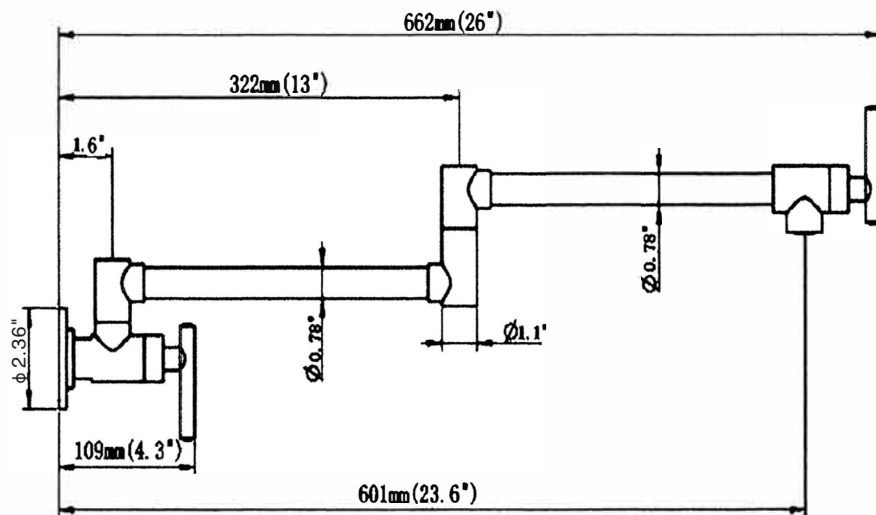

1、 Wrap the sealing tape on the 1/2 NPT thread joint and connect the water pipe

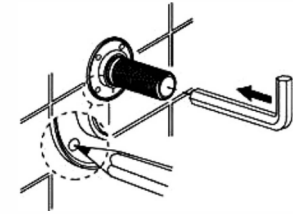

2、 Then use 10mm wrench to tighten into mounting hole

- Put flange on pot filler
- Mark the screw holes in the wall

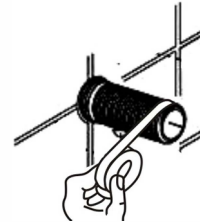

3、 Wrap the sealing tape on the another side of the thread.

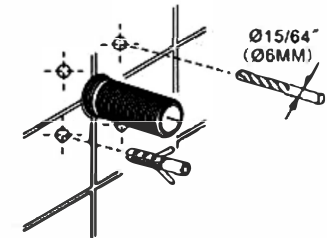

4、 Drill holes by an electric drill in the marked place and insert plugs. screw the flange on the wall.

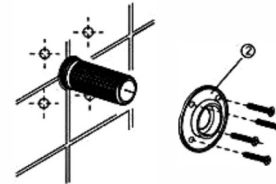

5、 Fasten flange to the wall by using the screws. Put the cover onto the flange.

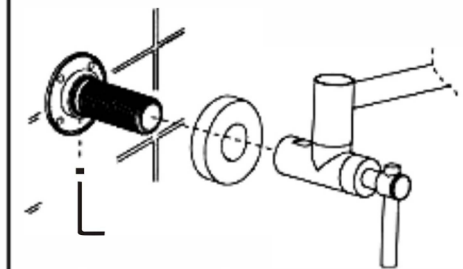

6、 • Screw on pot filler.

- Screw-in screw by using a 1.5mm Allen wrench to fasten pot filler to the flange.
- Cover and fasten flange to faucet.