























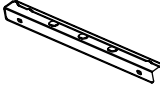

No.	#	QTY / CANT. / QTÉ	Description / Descripción / Description	Image / Imagen / Image
1		1	Main body Cuerpo principal Corps principal	
2	06-WDJ-1-02	1	Thermometer Termómetro Thermomètre	
3	04-XBS-05-PT2	2	Side handle Tirador lateral Poignée d'appoint	
4	02-DYX-03-US	1	Analog controller Regulador analógico Régulateur analogique	
5	06-YBL-40	1	Drip tray Bandeja recogegotas Bac récepteur	
6	Z-KE162810	1	Drip tray holder Soporte para bandeja recogegotas Support du bac récepteur	
7	H-KE162804	1	Left front leg Pata delantera izquierda Jambe avant gauche	
8	H-KE162805	1	Left back leg Pata trasera izquierda Jambe arrière gauche	
9	Z-KE162811	2	Back leg Pata trasera Patte arrière	
10	03-XKW-SK-01-A-DD1	3	Cooking grate Rejilla para asar Grille de cuisson	
11	03-XWJ-SK-01-A-DD1	1	Wood chip grate Rejilla para los trozos de madera Grille pour copeaux de bois	
12	06-SPL-06	1	Water pan Tazón de agua Cuvette d'eau	
13	06-SPL-01	1	Wood chip bowl with lid Rejilla para los trozos de madera Bac à copeaux de bois avec couvercle	
14	04-XBS-06-PT2 04-BST-40-DD1	1	Door handle Manija de puerta Poignée de porte	
15	06-XZL-1-19-DY	1	Wheel axle Eje de rueda Essieu de roue	
16	06-XZL-3-23-DD1	1	Rod Vara Tringle	
17	07-GGL-05-SI	3	"S" hook Gancho en forma de S Crochet en «S»	

No.	#	QTY / CANT. / QTÉ	Description / Descripción / Description	Image / Imagen / Image
18	05-SLL-27-BK	2	Wheel Rueda Roue	
19	Z-KE162830	2	Rod bracket Soporte de varilla Support de tige	

No.	#	QTY / CANT. / QTÉ	Image / Imagen / Image
A	M6×12	18	
B	M4×8	8	
C	Washer Arandela Rondelle	1	
D	Leg base Base de la pata Base des pieds	2	
E	Split pin Pasador partido Goupille fendue	1	

TOOLS REQUIRED / HERRAMIENTAS REQUERIDAS / OUTILS REQUIS

Phillips screwdriver
Destornillador phillips
Tournevis phillips



Before beginning assembly, make sure all parts are present. If any parts are missing or damaged, do not attempt to assemble the products. Contact customer service for replacement parts via telephone or email.

- Tools needed (not included): Phillips screwdriver
- Approximate assembly time: 15 minutes
- Note: 1. The right and left sides of the grill are designed as if you are facing the front of the grill.
2. Model shown for illustration purpose only, specific please in kind prevail.

Antes de comenzar el montaje, asegúrese de que todas las piezas estén presentes. Si falta alguna pieza o está dañada, no intente ensamblar los productos. Póngase en contacto con el servicio de atención al cliente para obtener piezas de repuesto por teléfono o correo electrónico.



- Herramienta necesaria (no incluido): Destornillador phillips
- Tiempo aproximado de ensamblaje: 15 minutos
- Nota: 1. Los lados derecho e izquierdo de la parrilla están diseñados como si estuvieras frente a la parte delantera de la parrilla.
2. El modelo que se muestra es sólo para fines ilustrativos, prevalecen los específicos en especie.

Avant de commencer l'assemblage, assurez-vous que toutes les pièces sont présentes. Si des pièces sont manquantes ou endommagées, n'essayez pas d'assembler les produits. Contactez le service de clientèle pour les pièces de rechange par téléphone ou par e-mail.

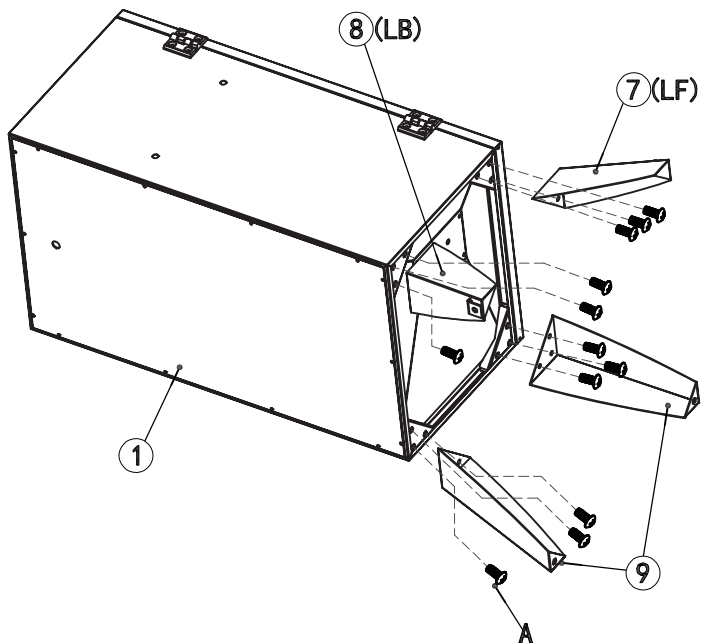

- Outils nécessaires (non inclus): Tournevis phillips
- Temps nécessaire pour l'assemblage: 15 minutes
- Remarque: 1. Les côtés droit et gauche du gril sont conçus comme si vous faisiez face à l'avant du gril.
2. Le modèle est présenté à des fins d'illustration uniquement, spécifiques en nature prévalent.

1 A  ×12

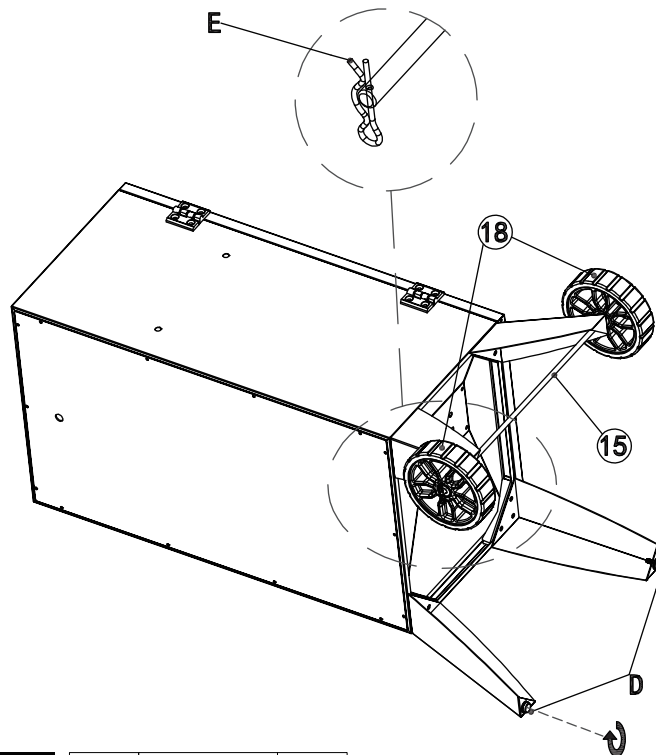

2 D  ×2
E  ×1



3 A  ×6
C  ×1

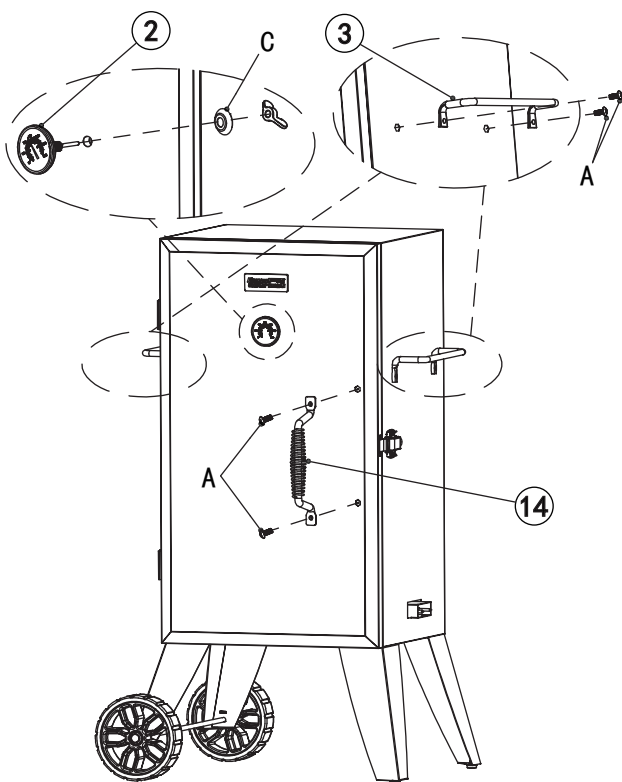

4 B  ×8

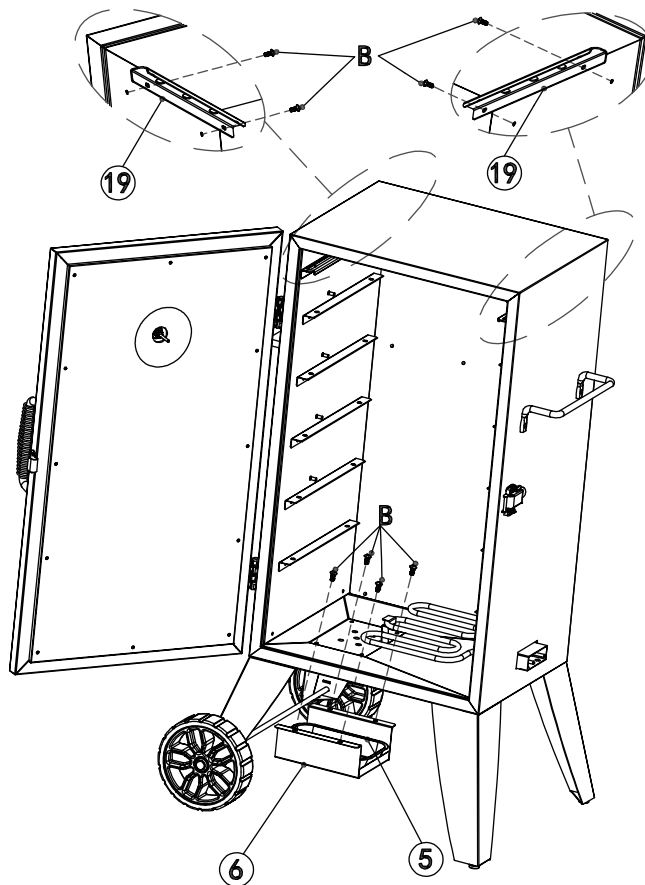

5

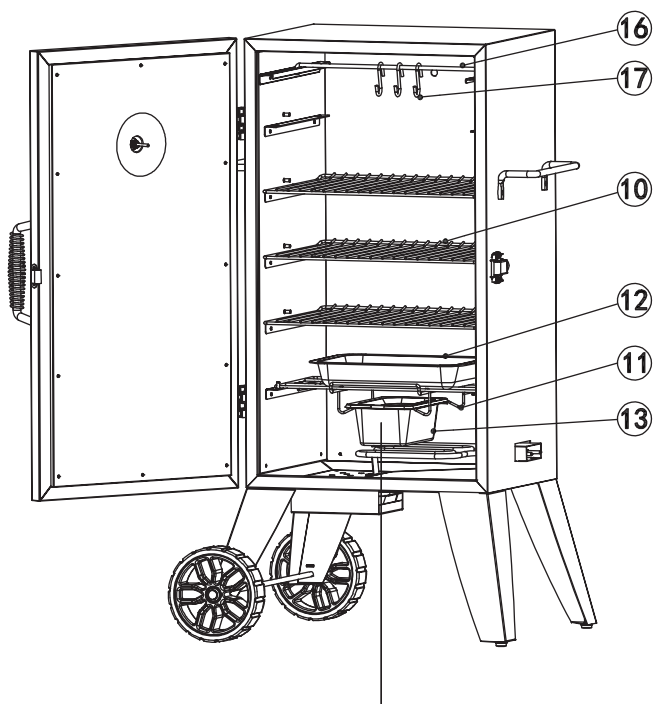

6

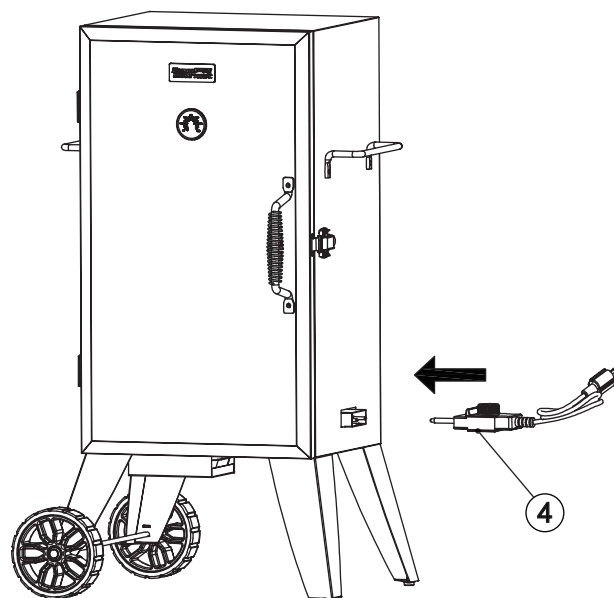

- Remove protective film before using.
- Retire la película protectora antes de usar.
- Retirez le film protecteur avant utilisation.

**Thank You
For Choosing Us.**

**Any Problem!
We Can Help!**

**Customer
Service**

1-800-618-6798

Monday to Friday (8:30 am - 5:00 pm EST)

service@royalgourmetusa.com