



Features

- End drain.
- Bask® heated surface creates spa-like relaxation with soothing warmth on your back, shoulders, and neck.
- Integral lumbar support and armrests for comfort.
- Textured bottom surface.
- 72" (1829 mm) x 36" (914 mm) x 20" (508 mm)

Material

- Acrylic

Installation

- Drop-in

Recommended Accessories

- K-1283 Removable Apron
- K-1491 Bath/Whirlpool Pillow
- K-7166-AF Bath Drain
- K-24916 Wireless Music Kit



Codes/Standards

- CSA B45.5/IAPMO Z124
- ASTM E162
- ASTM E662
- UL 1795
- Greenguard UL 2818 - Gold

KOHLER® Plastic Baths and Receptors Lifetime Limited Warranty





KOHLER® Hydrotherapy Components Five-Year Limited Warranty

See website for detailed warranty information.

Available Color/Finishes

Color tiles intended for reference only.

Color Code Description

| | | |
|--|----|---------|
|  | 0 | White |
|  | 96 | Biscuit |
|  | 47 | Almond |
|  | NY | Dune |
|  | G9 | Sandbar |

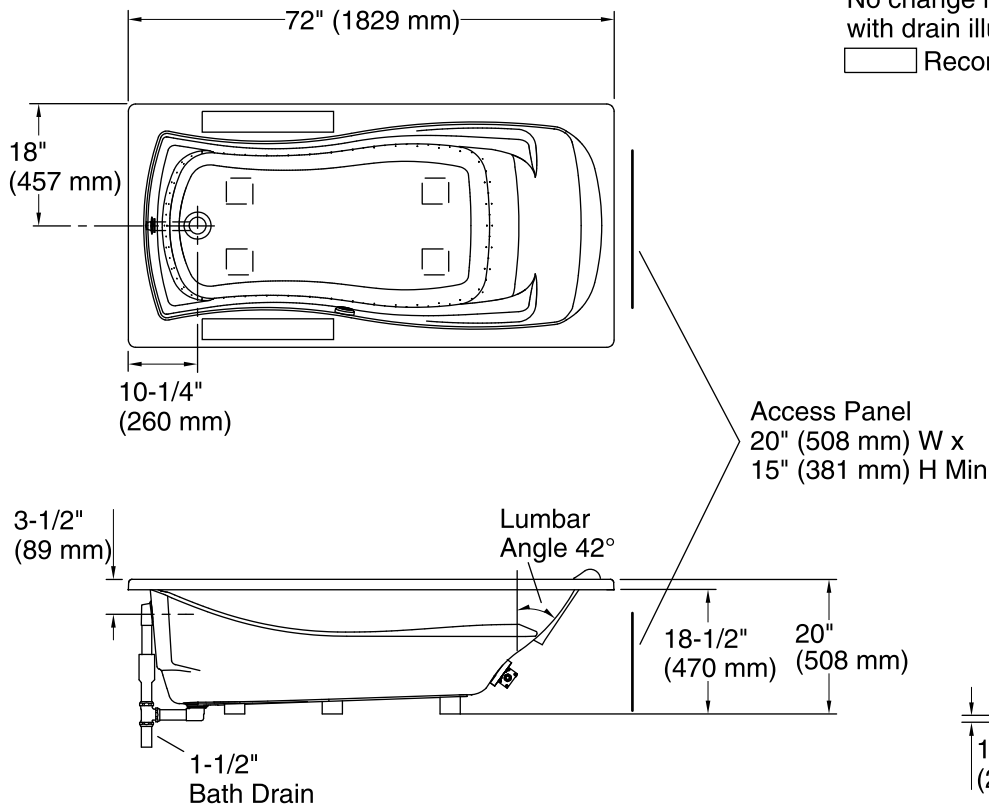

No change in measurements if connected with drain illustrated. (K-7166-AF)

□ Recommended Faucet Location

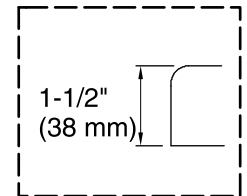

Drop-in Rim Detail

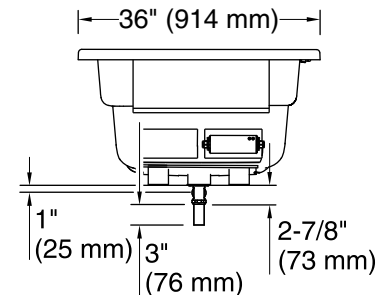

Required Electrical Service

One circuit required, protected with Class A Ground-Fault Circuit-Interrupter (GFCI) or Residual Current Device (RCD).

Heated Surface: 120 V, 15 A

Technical Information

All product dimensions are nominal.

| | |
|------------------------------|---|
| Installation: | Drop-in |
| Drain location: | End |
| Basin area, bottom: | 50" x 24" (1270 mm x 610 mm) |
| Basin area, top: | 65" x 27" (1651 mm x 686 mm) |
| Weight: | 77 lbs (34.9 kg) |
| Minimum floor load: | 39.1 lbs/ft ² (190.9 kg/m ²) |
| Water depth: | 14" (356 mm) |
| Water capacity: | 72 gal (272.5 L) |
| Electrical component rating: | Heated Surface: 120 V, 0.5 A, 60 Hz, 65 W |
| Minimum flat for door: | 2-1/8" (54 mm) |

Notes

Measure your actual product for rough-in details. Install this product according to the installation instructions.

The hot water supply should be 70% of the capacity of the bath or greater. Installations will vary.

If installing a rim-mount faucet, make sure there is no interference above or below the deck before drilling any holes.