

Swivel Rocker

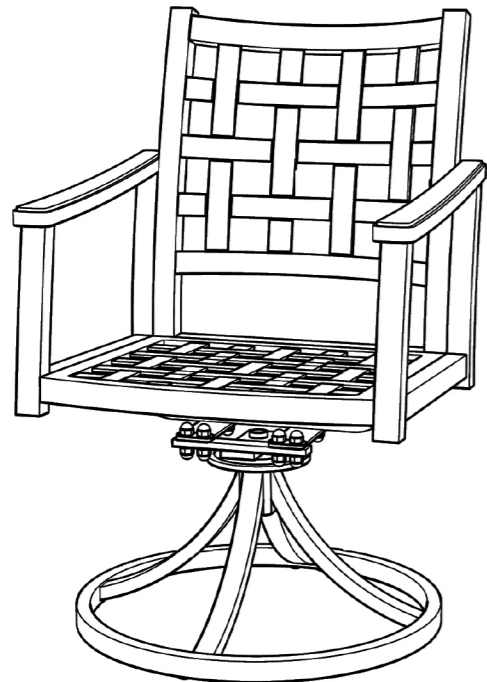







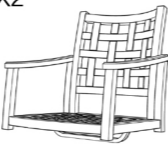

ASSEMBLY INSTRUCTIONS

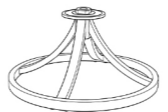
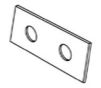
OE2-FK02KD



BEFORE ASSEMBLY:

- Please read these instructions carefully before starting assembly. We suggest you carry out the assembly on a soft surface like a carpet, so as to avoid scratching the paint. Keep children away during assembly. This item contains small parts which can be swallowed by children.
- This product was made for the explicit purpose of providing outdoor function and is not to be used as a toy. This product is for residential use only. This product is not intended for commercial use; unintended use will void the warranty.
- This product is not intended for use during inclement or severe weather, that includes but is not limited to rain, hail, sleet, snow, wind, freezing conditions and extreme heat.
- Please note because of the nature of cast metal, you may find roughness on the surface which enhances the beauty of the product and is not a defect.
- Aluminum is soft metal, please do not use power tools, and over tighten may strip threads or break the parts.
- When not in use, store and/or cover the product in a cool dry location. Do not locate the product near any sort of high heat. Do not use the product as a support.
- Children under the age of 10, who are near the product, should be supervised by a competent adult at all times.
- Do not discard any of packaging until you finish the assembly. Keep the assembly instructions for future reference or warranty.

AX2  Seat	BX2  Connector	CX2  Base	DX8  Double Hole Washer
EX8  Bolt(M8*40)	FX8  Nut	GX32  Cap	HX8  Spring Washer
IX8  Washer	JX2  Cushion	KX4  Wrench	

1

Step 1: Place all the parts on a clean and soft surface. Identify all the parts and hardware kits against parts list. Assemble **Seat(A)** and **Connector(B)** first, and make sure the direction of **Connector(B)** is correct as **Fig(1)**. This is very important for safety.

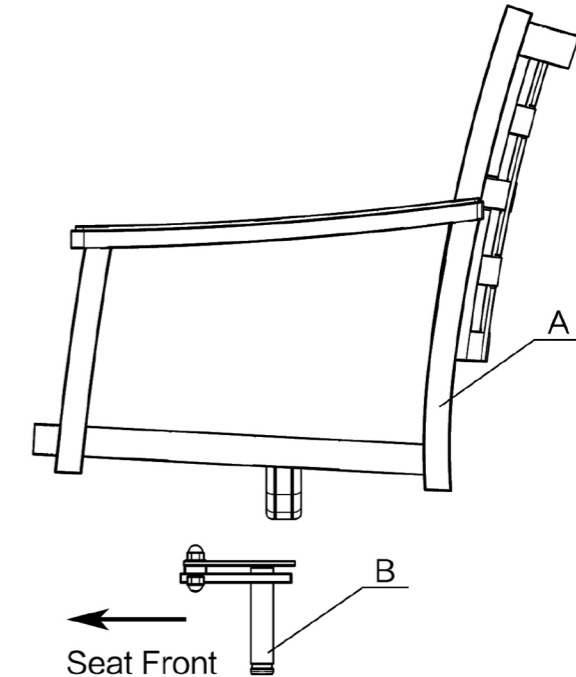

(1)

2

Step 2: Install hardware parts (D,E,G) and (D,I,H,F,G) in the order displayed in Fig(2). Tighten the bolts and nuts with Wrench(K), do not over-tighten all the bolts and nuts, it will cause the damage of U-bar of Seat(A). Then, after tightening all bolts and nuts, install Cap (G) on all bolts and nuts.

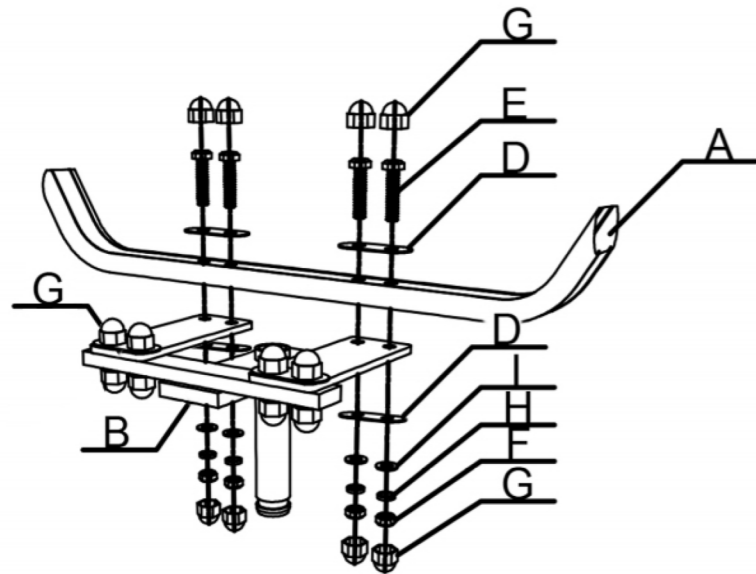

(2)

3

Step 3: Insert the installed pivot shaft into the Base(C) as Fig(3).

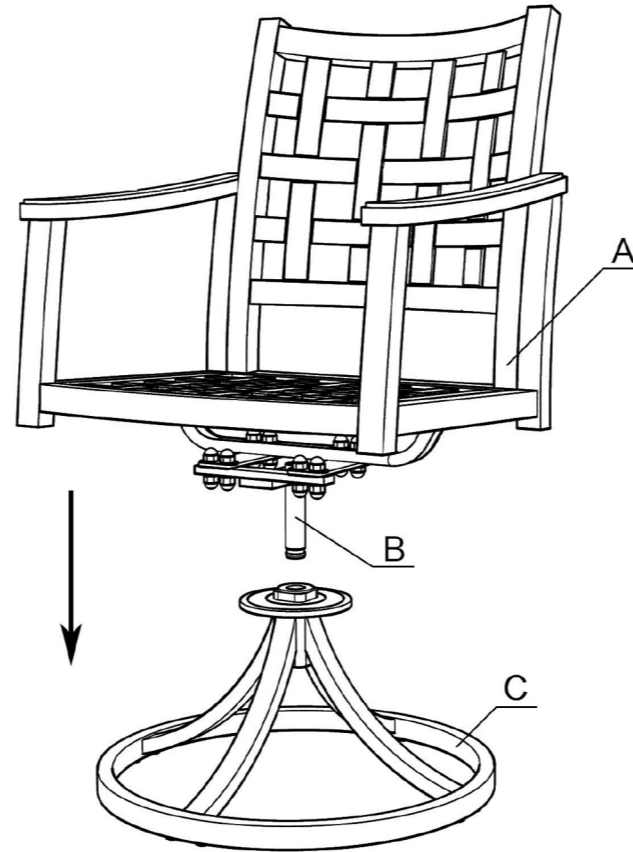

(3)

4

Step 4: Tie the Cushion(J) as Fig(4). Now, your chair should be ready for use.

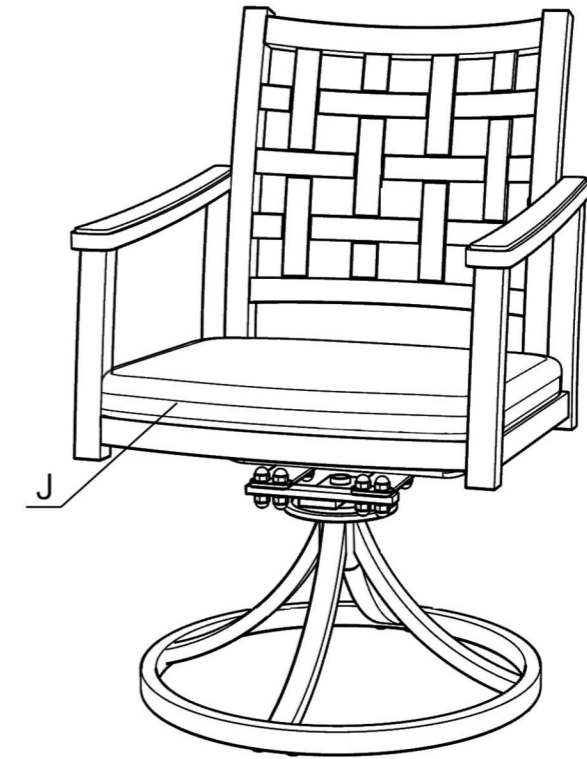

(4)

Tip: Tighten all the bolts and nuts with Wrench(K)