

20.0 SPEAKER MOUNT USER'S GUIDE

REQUIRED TOOLS

- A. 5/32" hex wrench (supplied)
- Drill bits:
 - B. Wood 5/32"
 - C. Drywall - 1/4"
 - D. Masonry - 5/16" carbide tipped
- E. Crescent or 9/16" (11mm) open end wrench
- F. Phillips screwdriver
- G. Electric drill
- H. Hammer (masonry only)

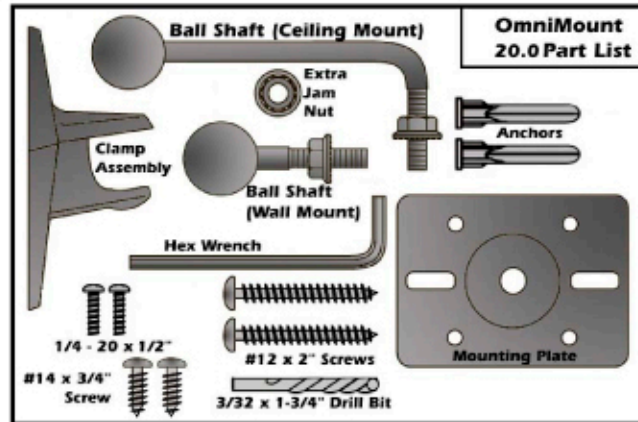

1. SPEAKER OPTIONS

A) 3/8"-16 Threaded Insert



B) Mounting Plate

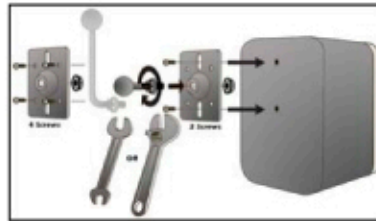

C) Wood Speaker Without Threaded Inserts



Use 3/32" drill bit (supplied)
Maximum drill depth: 1/2"

2. CLAMP ASSEMBLY ORIENTATION

A) Wall Mount

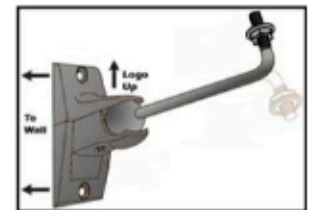
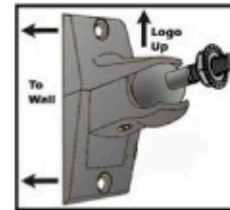

A) Ceiling Mount

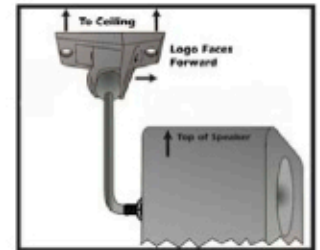
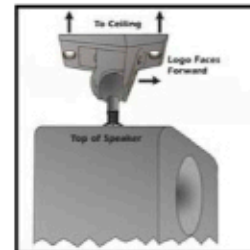

3. MOUNTING THE CLAMP ASSEMBLY

A) Mark Location

Mark mounting holes with pencil

B) Mounting onto Wooden Stud. Use 5/32" drill bit

Minimum mounting hole depth: 2" (51mm)

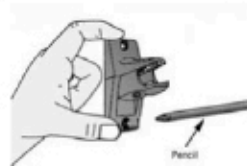

C) Drywall Mounting

Use 1/4" drill bit

Insert anchor into hole

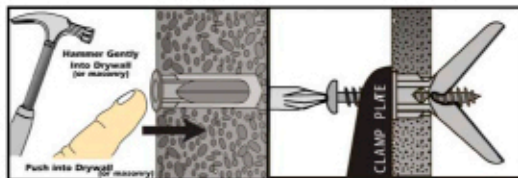

D) Mounting into Masonry

5/16" (8mm) carbide tipped bit and masonry or hammer drill.

Wear eye protection.

Minimum mounting hole depth: 2" (51mm)

Insert anchor into hole

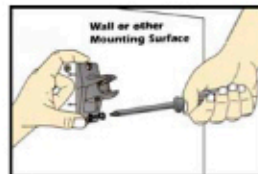

E) Mount Clamp Assembly

Attach clamp assembly with supplied screws.

4. JOINING BALL SHAFT AND CLAMP ASSEMBLY

Open clamp assembly enough to accept ball.

"Pop" ball into the clamp assembly.

Set speaker to desired position.

Tighten clamp assembly until snug.

Note: Speaker weight must be fully supported during the tightening process.



5. FINAL ADJUSTMENTS

Use tool to tighten in 1/2 turn increments.

Do not over tighten.

To change speaker angle, loosen tension screw, re-position speaker, then re-tighten tension screw.

To rotate speaker cabinet, loosen jam nut, rotate speaker into desired position, then re-tighten jam nut

