







# Assembly Instructions

**Caution : You must read this before you proceed**

## Care & Maintenance

	<ul style="list-style-type: none"><li>● Not for commercial use. For residential use only.</li></ul>
	<ul style="list-style-type: none"><li>● Furniture may scratch floors. We recommend using furniture pads to protect your floors.</li></ul>
	<ul style="list-style-type: none"><li>● Do not put hot items directly on furniture surface.</li></ul>
	<ul style="list-style-type: none"><li>● Do not clean furniture with harsh cleansers or polish.</li></ul>
	<ul style="list-style-type: none"><li>● Do not place furniture under direct sunlight.</li></ul>
	<ul style="list-style-type: none"><li>● Do not place furniture near heating or cooling vents.</li></ul>
	<ul style="list-style-type: none"><li>● Do not write on furniture without a padded barrier to protect the surface.</li></ul>
	<ul style="list-style-type: none"><li>● Do not place furniture outside . For indoor use only.</li></ul>
	<ul style="list-style-type: none"><li>● Stains may be removed with mild soap solution and damp cloth.</li></ul>
	<ul style="list-style-type: none"><li>● Children should not climb or jump on the furniture.</li></ul>
	<ul style="list-style-type: none"><li>● Dust and pick-up spills using a clean, non-colored, lint-free cloth.</li></ul>

Please look in sofa for hardware packs and legs.

Sets often ship in multiple boxes and may arrive a day or two apart.

## 3-SEATER SOFA

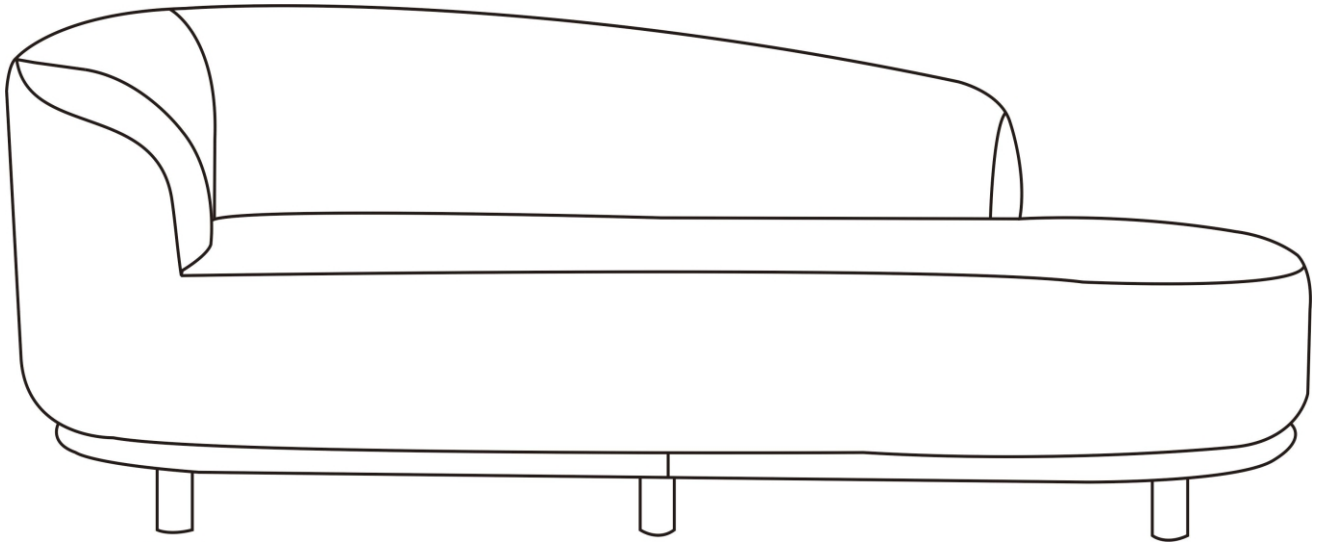





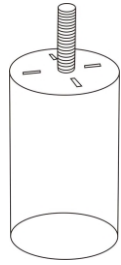

### Parts List

Label	Picture	Description	QTY
A	A rectangular wooden base frame with rounded corners on the left side. It has two circular holes for screws, one near the top and one near the bottom.	Left Wooden Base Frame	1
B	A rectangular wooden base frame with rounded corners on the right side. It has two circular holes for screws, one near the top and one near the bottom.	Right Wooden Base Frame	1
C	A line drawing of a three-seater sofa, identical to the one shown at the top of the page.	Three-seater Sponge Sofa	1

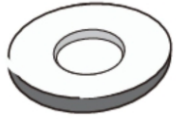
D		Rubber Feet	6
---	---	-------------	---

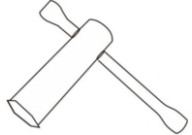
## Hardware

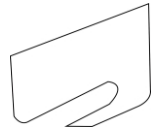
Label	Picture	Description	QTY
①		Single Head Screw(M8×80mm)	3
②		Nut(M8)	3
③		Gaskets (M6*18mm)	5
④		Spring Shims(M8)	5
⑤		Wrenches(M8)	1
⑥		Allen Wrench(M8)	1
⑦		Blades	1

# Assembly Preparation

Before Beginning Assembly :

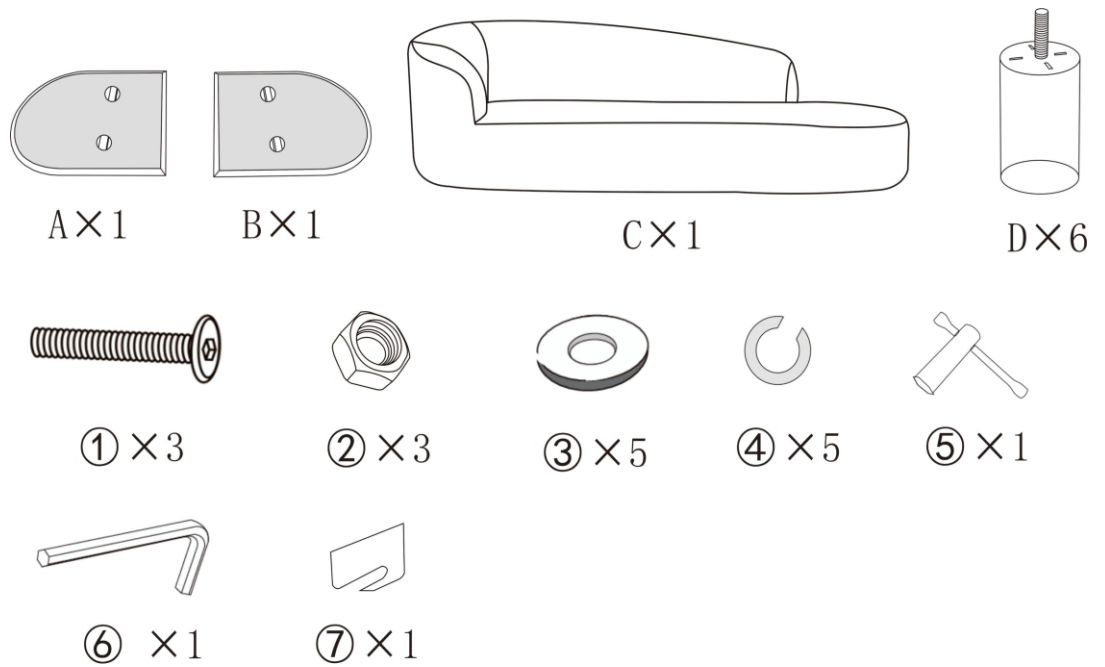

- Read instructions, cover to cover-



- Have 2 adults on hand for assembly-



- Do not assemble on flooring or carpet-



- Assemble on a clean non-marring surface (packing foam)-



- Save all packaging until finished-

# Assembly Steps

## Overview

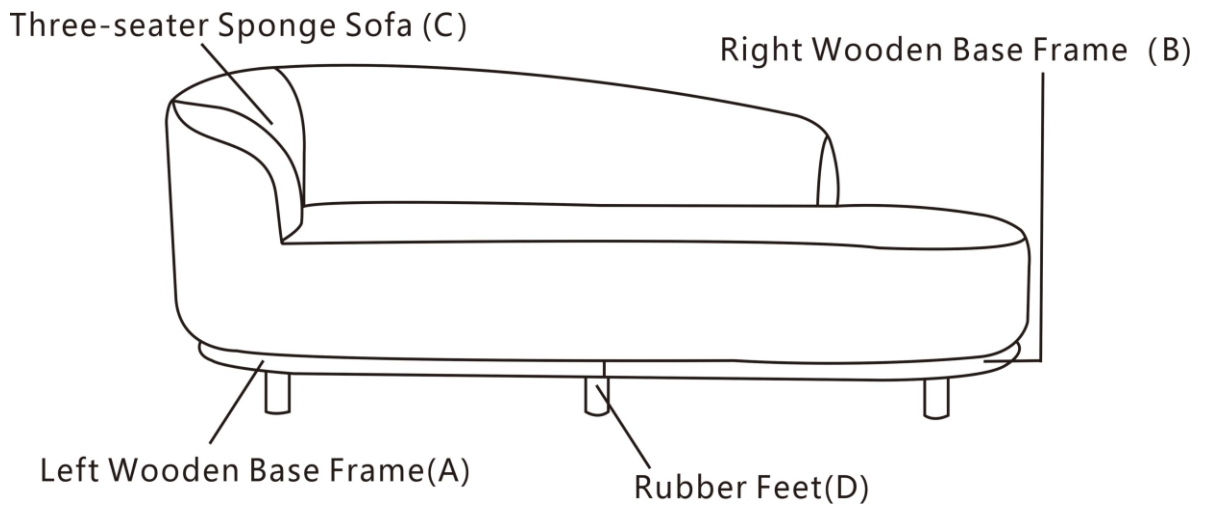

This 3-Seater Sofa has multiple parts and may require up to some 30 minutes to assemble.

To give you an overview of the 3-Seater Sofa parts, the above picture is to help you put the various parts into perspective.

Please read through the instructions below to familiarise yourself with the parts and steps before assembly.

Note:It is recommended that you have an adult partner to assist during the entire assembly process.

**Step 1**

Cardboard box 2-1

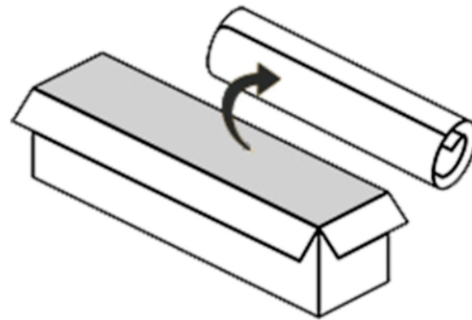

Remove the compressed package from the Cardboard box 2-1.

**Step 2**

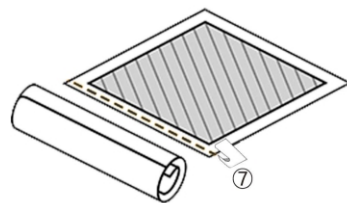

Note:Please use the specialised Blade (⑦) to open the vacuum-sealed bag.



⑦ × 1

C × 1

Unfold the compressed package flat. Use a Blade (⑦) to cut along one edge of the package. Remove the Three-seater Sponge Sofa (C) and place them on a clean, flat surface free of scratches.

**Step 3**

Cardboard box 2-2

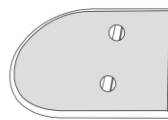
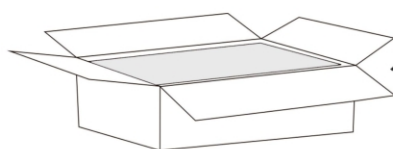

A × 1

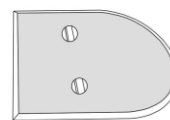

B × 1



D × 6



Hardware bag

Remove the Left Wooden Base Frame (A), Right Wooden Base Frame (B), Rubber Feet (D), and hardware accessories bag from Cardboard box 2-2. Place them on a clean, flat surface free of scratches.

**Step 4**

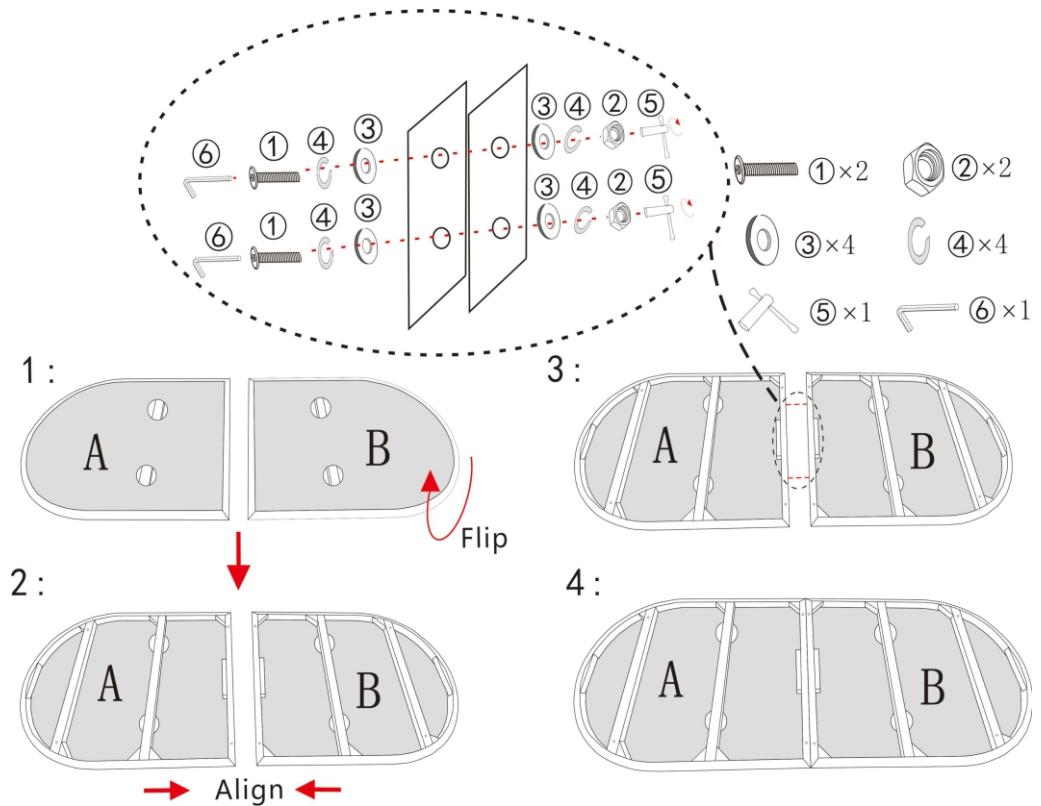

As illustrated:

1. Flip the Left Wooden Base Frame (A) and Right Wooden Base Frame (B).
2. Align the holes on both sides of the Left Wooden Base Frame (A) simultaneously with the corresponding holes on the Right Wooden Base Frame (B).
3. Securely fasten the frames together as follows:
  - . On the left side, use Allen Wrench (⑥), Single Head Screw (①), Spring Shims (④), and Gaskets (③)
  - . On the right side, use Gaskets (③), Spring Shims (④), Nut (②), and Wrench (⑤)

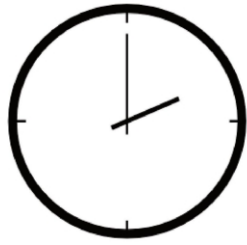

... Wait **72h**

After opening the compression bag (Note: Please do not cut with a knife, so as not to damage to the product), the corners around the cushions if there are wrinkles, you need to wait for about 72 hours, it is recommended that guests pat and knead the corners of the sofa, in order to sponge better recovery.

If you need any help, please take a picture and contact the seller.

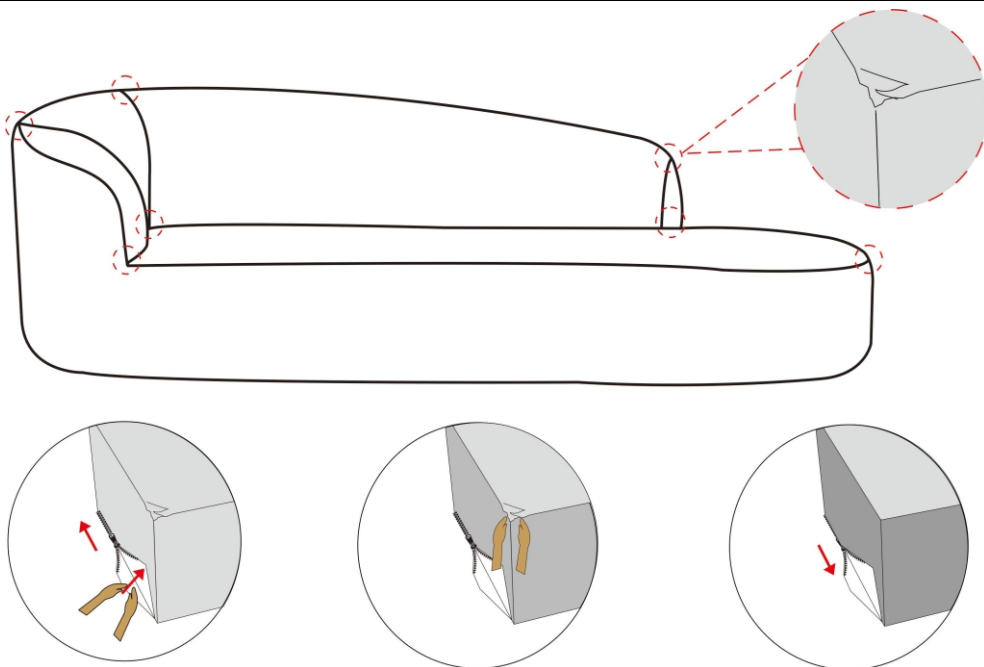

If you see the folds,unzip the bottom of the product,put your hand in,gently pat and knead to tidy up the creased sponge,wait for the sponge to become full and flat before zipping up the bottom of the product.

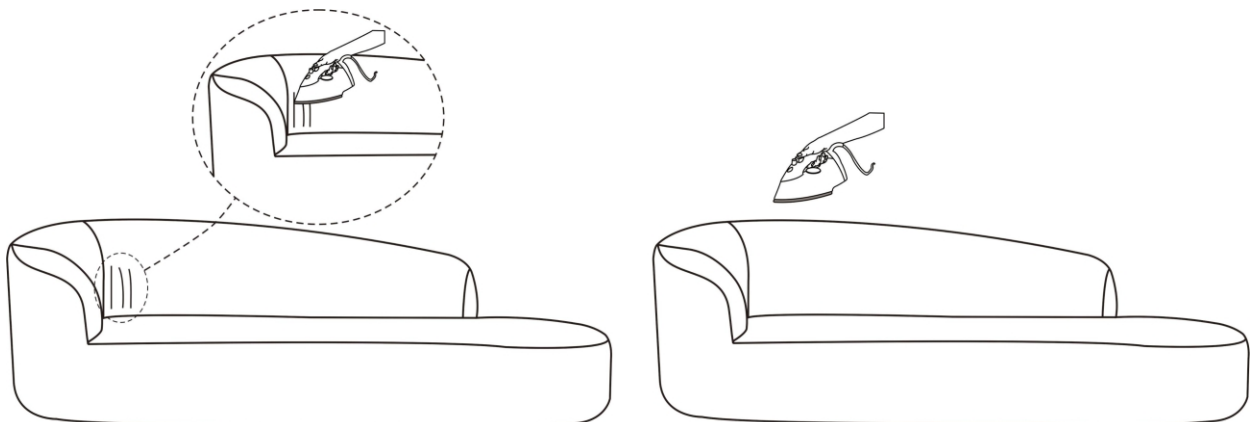

Partial wrinkles on the surface of the fabric can be gently smoothed out using an iron on a low heat setting.

**Step 5**

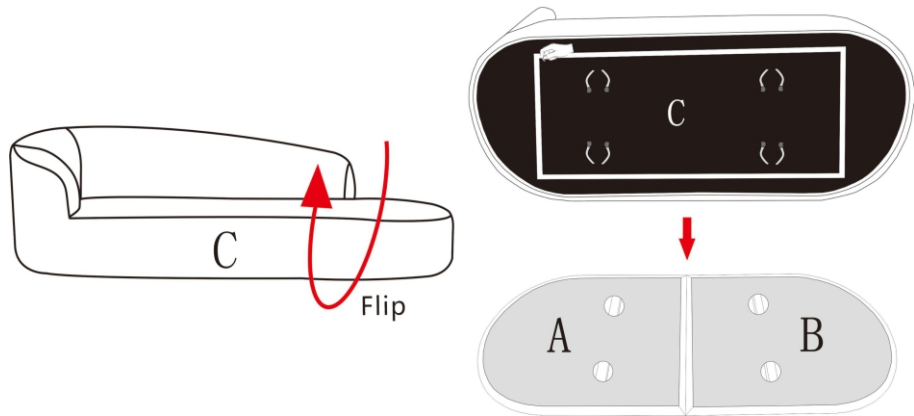

As illustrated:

1. Flip Three-seater Sponge-Sofa (C) over.
2. Peel off the adhesive backing from the reverse side of the velcro strip at its base, position the Three-seater Sponge Sofa (C) atop the Left Wooden Base Frame (A) and Right Wooden Base Frame (B), ensuring the velcro strip on the sofa's underside aligns correctly with the corresponding velcro strip on the base frames.
3. Thread the velcro strip on the underside of the Three-seater Sponge Sofa (C) through the corresponding holes in the base frame.

**Step 6**

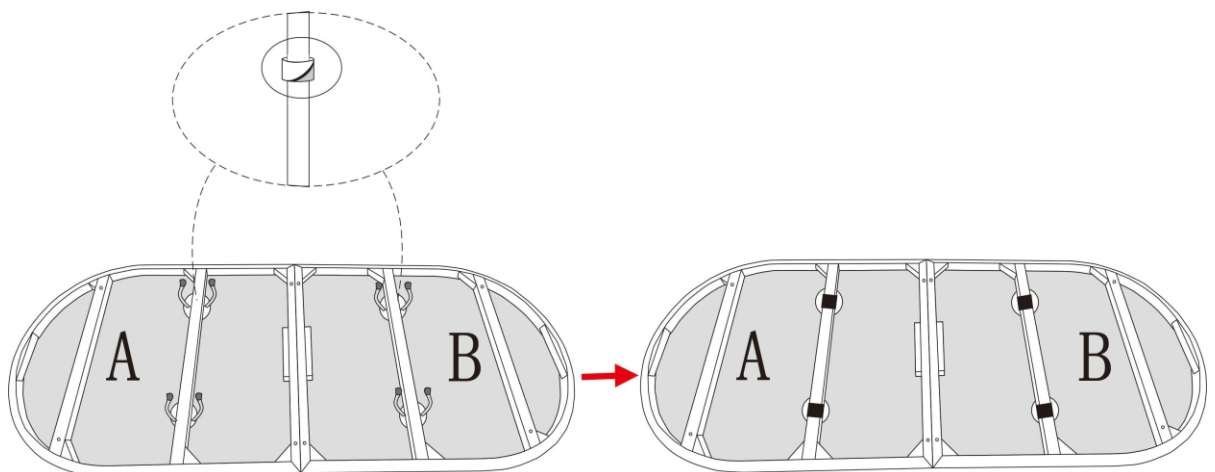

Thread the velcro strip through the holes and wrap it securely around the wooden base strip.

**Step 7**

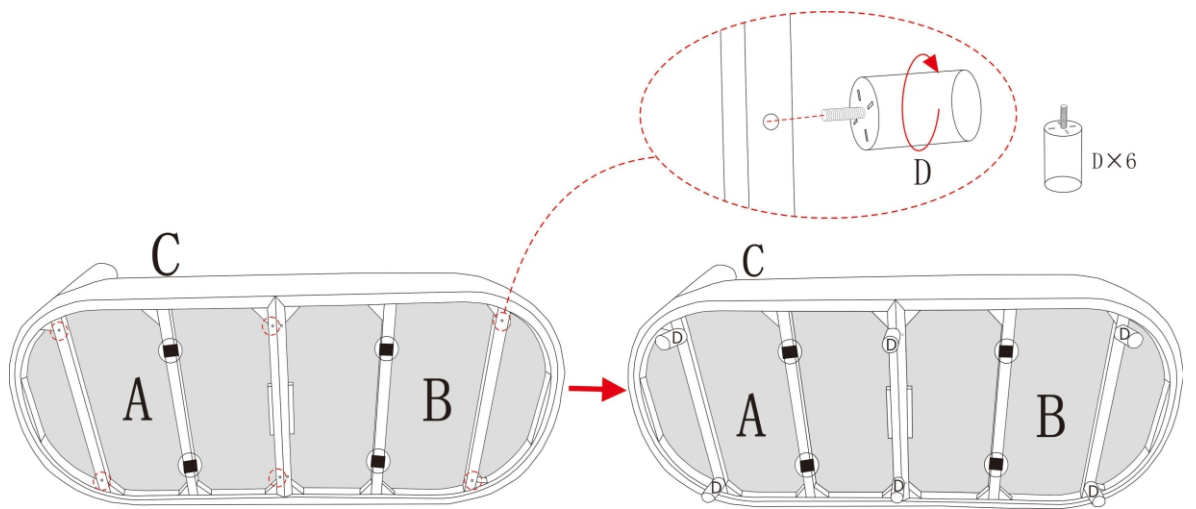

As illustrated: Rotate clockwise the Rubber Feet (D) clockwise to engage it into the corresponding holes on the Left Wooden Base Frame (A) and Right Wooden Base Frame (B).

**Step 8**

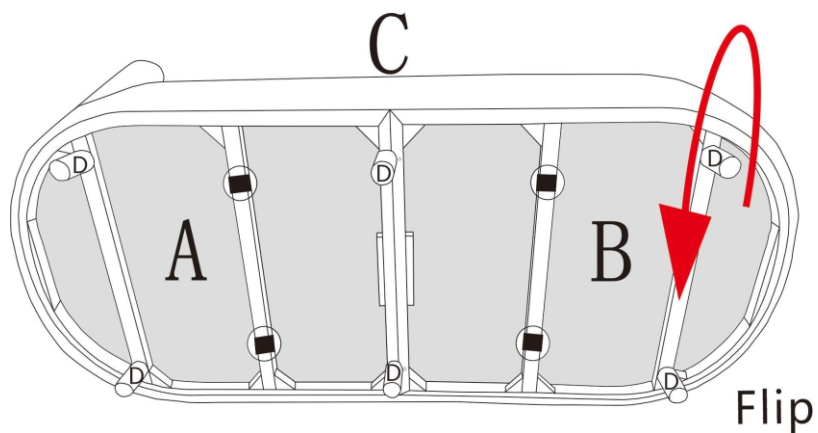

Flip the entire component upside down

**Step 9**

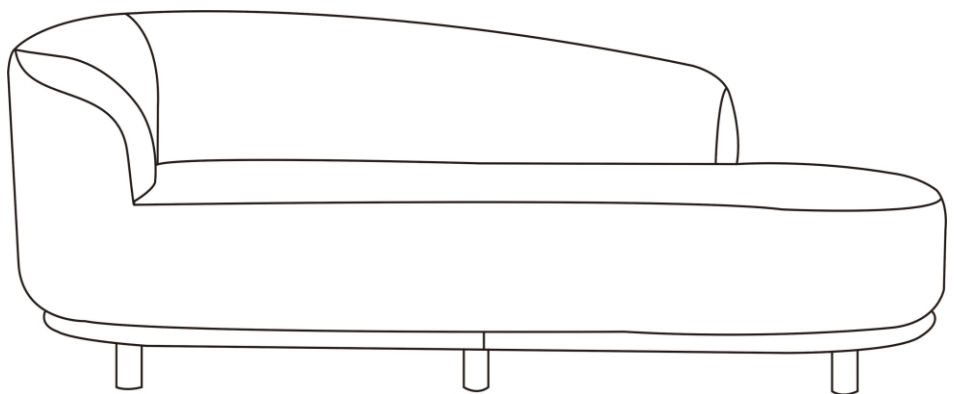

Your sofa is ready for use.  
This sofa should only be used on flat, level surfaces.

## Questions & Answers about Proposition 65

- What is Proposition 65?

Proposition 65 requires businesses to provide warnings to Californians about significant exposures to chemicals that cause cancer, birth defects or other reproductive harm. These chemicals can be in the products that Californians purchase, in their homes or workplaces, or that are released into the environment. By requiring that this information be provided, Proposition 65 enables Californians to make informed decisions about their exposures to these chemicals.

Proposition 65 also prohibits California businesses from knowingly discharging significant amounts of listed chemicals into sources of drinking water.

Proposition 65 requires California to publish a list of chemicals known to cause cancer, birth defects or other reproductive harm. This list, which must be updated at least once a year, has grown to include approximately 900 chemicals since it was first published in 1987.

- What types of chemicals are on the Proposition 65 list?

The list contains a wide range of naturally occurring and synthetic chemicals that include additives or ingredients in pesticides, common household products, food, drugs, dyes, or solvents. Listed chemicals may also be used in manufacturing and construction, or they may be byproducts of chemical processes, such as motor vehicle exhaust.

- What does a warning mean?

If a warning is placed on a product label or posted or distributed at a workplace, a business, or in rental housing, the business issuing the warning is aware or believes that it is exposing individuals to one or more listed chemicals.

By law, a warning must be given for listed chemicals unless the exposure is low enough to pose no significant risk of cancer or is significantly below levels observed to cause birth defects or other reproductive harm.

- Where can I get more information on Proposition 65?

If you have specific questions on the administration or implementation of Proposition 65, you can contact OEHHA's Proposition 65 program at [P65.Questions@oehha.ca.gov](mailto:P65.Questions@oehha.ca.gov), or by phone at (916) 445-6900.