

Installation Guide

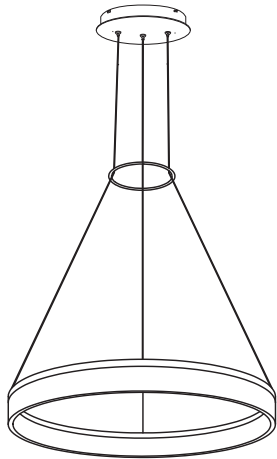

VONN Lighting
Model: VMC31630



LED INFO & WARNINGS

- Please read and comprehend the entire manual before attempting to assemble, operate, or install the product.
- Make sure that you have all necessary parts by checking the parts list. If any part is missing or damaged, please contact **VONN Lighting Customer Service at 888-604-8666** for a replacement.
- All parts must be used as indicated in these instructions. Do not substitute any parts, leave parts out, or use any parts that are worn or broken.
- Inspect the LED fixture prior to installation to make sure that it has not been damaged during shipping.
- Please handle the LED light with care when unpacking. Do not apply pressure to the LED's, do not open any factory sealed compartments, and do not touch the LEDs with your hands.

VONN highly recommends to use a qualified, licensed electrician to install the fixture.

- VONN recommends to install the fixture on its own independent circuit. Do not install the fixture on the same circuit with other appliances, or HVAC systems.
- Do not remove or replace VONN manufactured driver that is provided with the fixture.

DO NOT CUT WIRES attached to the fixture under any circumstance. Cutting wires will **VOID** your warranty. Excess cable should be neatly looped and tucked into the canopy.

- Please remove the canopy from the box prior to the fixture body. Failure to do so can potentially lead to cables getting tangled.
- VONN recommends **ELV (Electric Low Voltage)** type dimmers for this fixture.
- Shut "OFF" the electricity at main fuse box.
- Place the wall switch in the "OFF" position of the room you are installing the fixture.

Parts List

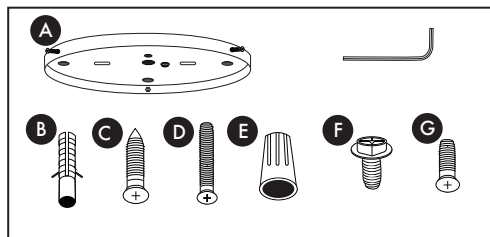

- A. Canopy Cover
- B. Plastic Anchors x 4
- C. Anchor Screws x 4
- D. Outlet Screws x 3
- E. Wire Connectors x 3
- F. Ground Screw x 1
- G. Canopy Screws x 3

Circuit Box

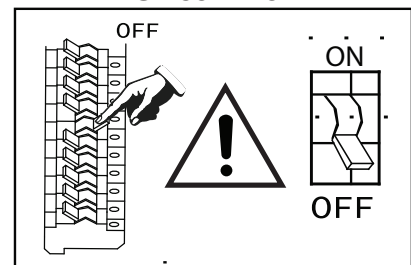

Tools You May Need

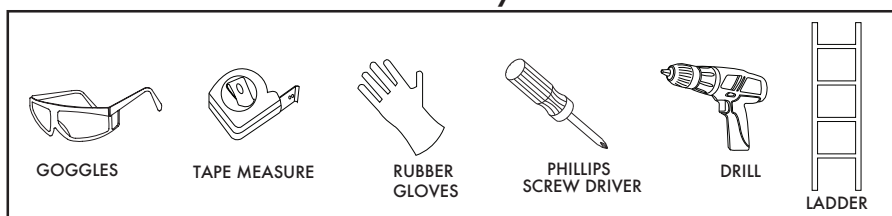

Fixture Diagram

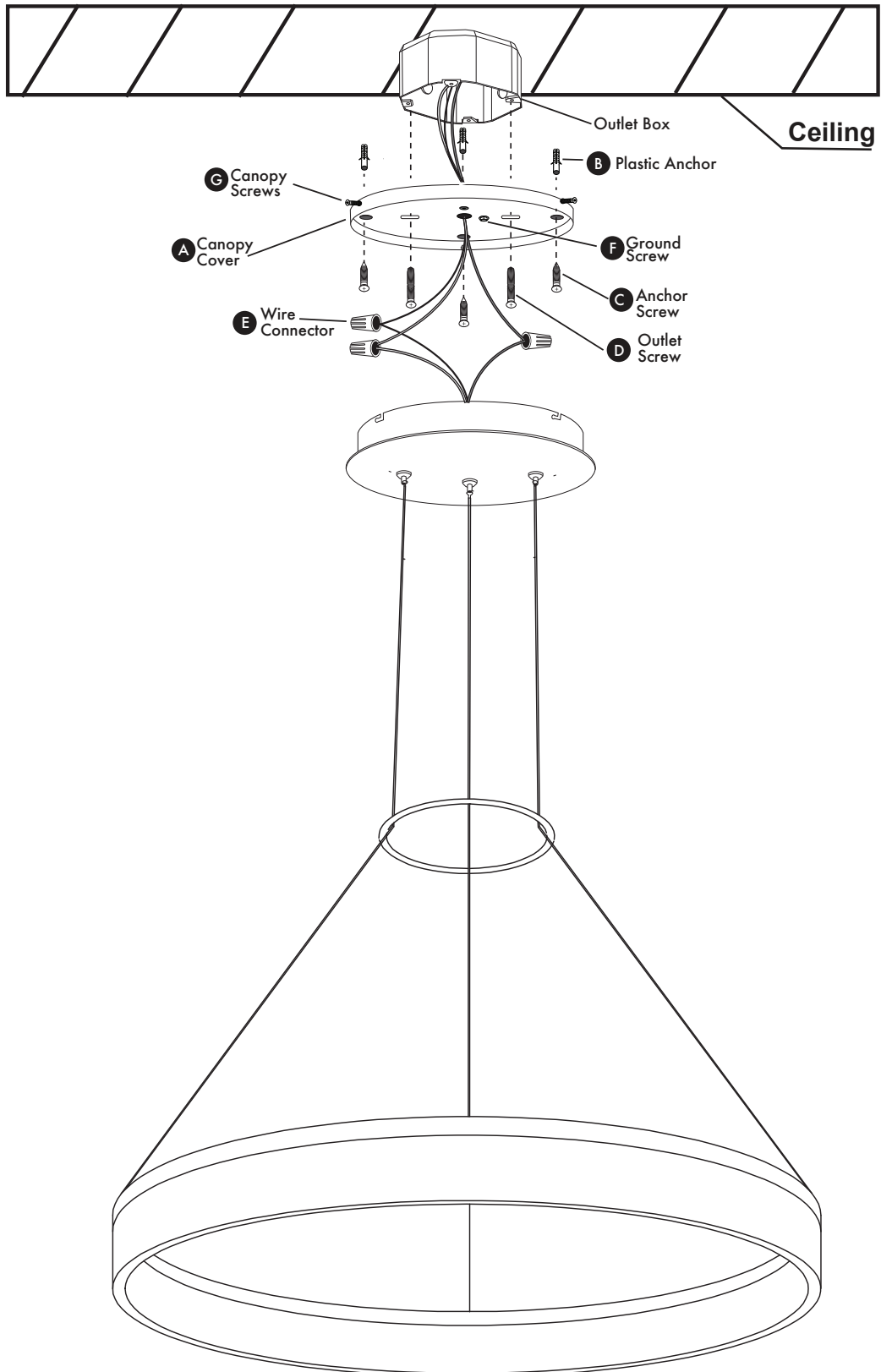

Step 1. Adjust Height

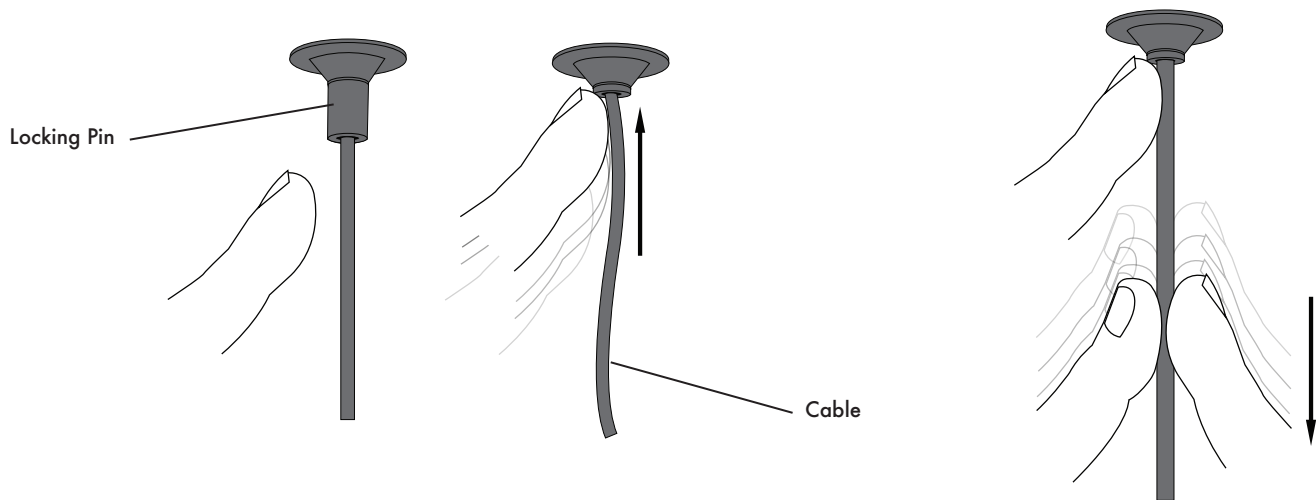

The length of the cable is adjustable. To determine the proper length of the fixture, hold the fixture canopy up against the outlet box in the ceiling to adjust the cable.

Depress locking pin on the canopy, hold pin in place, and pull down or push up on the cable. Repeat step for each cable.

Installer Tip (1): It is recommended that two installers are required to adjust the height of the fixture. One installer to hold the fixture, and the second installer to adjust the cables.

Step 2. Install Canopy Cover

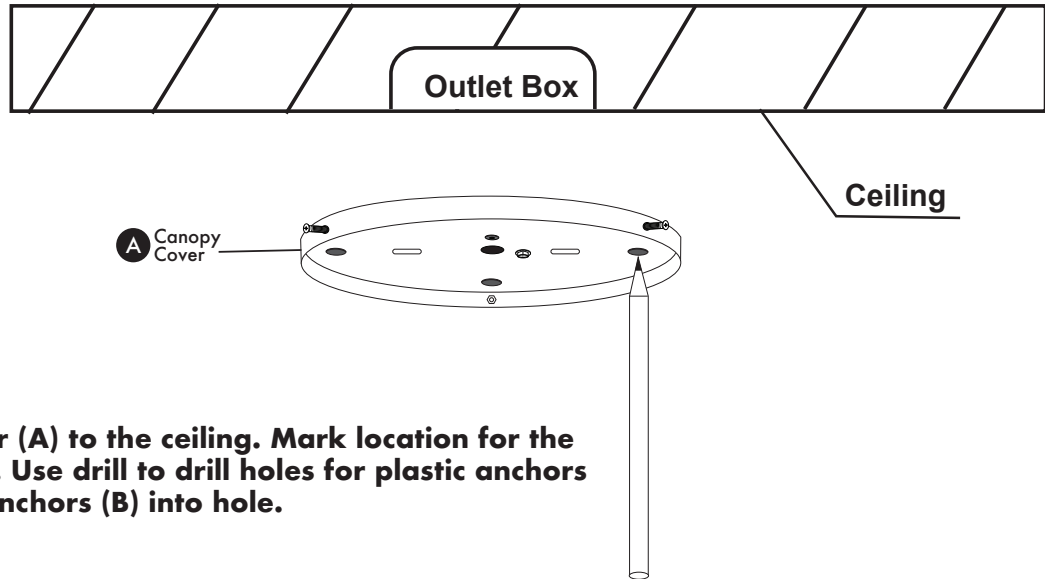

Raise canopy cover (A) to the ceiling. Mark location for the plastic anchors (B). Use drill to drill holes for plastic anchors (B). Insert plastic anchors (B) into hole.

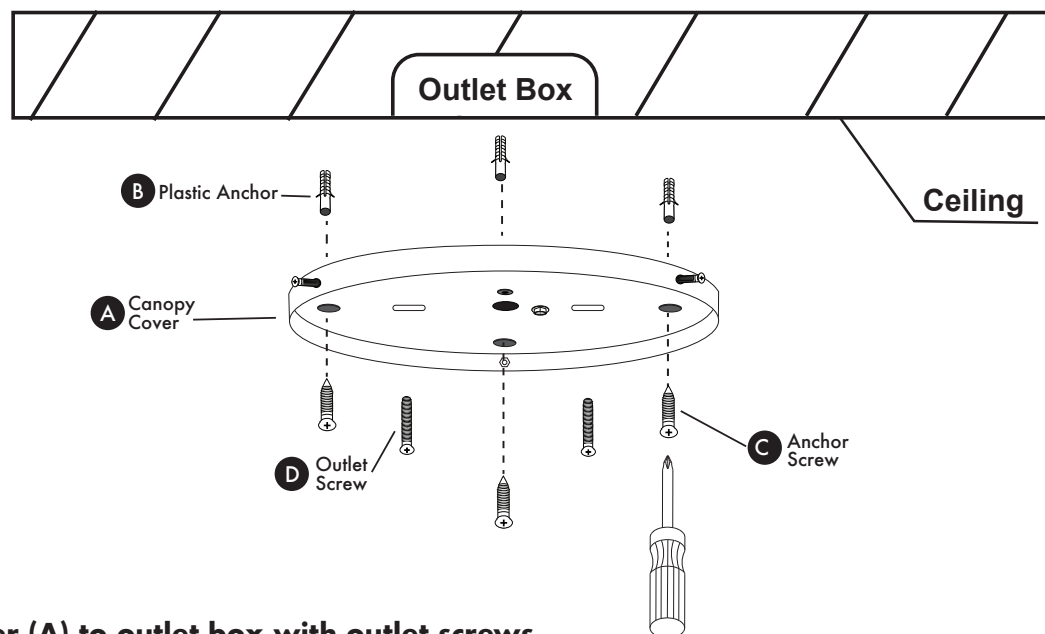

Attach canopy cover (A) to outlet box with outlet screws (D). Screw anchor screws (C) into plastic anchors (B) to secure canopy cover (A).

Step 3. Connect Wires

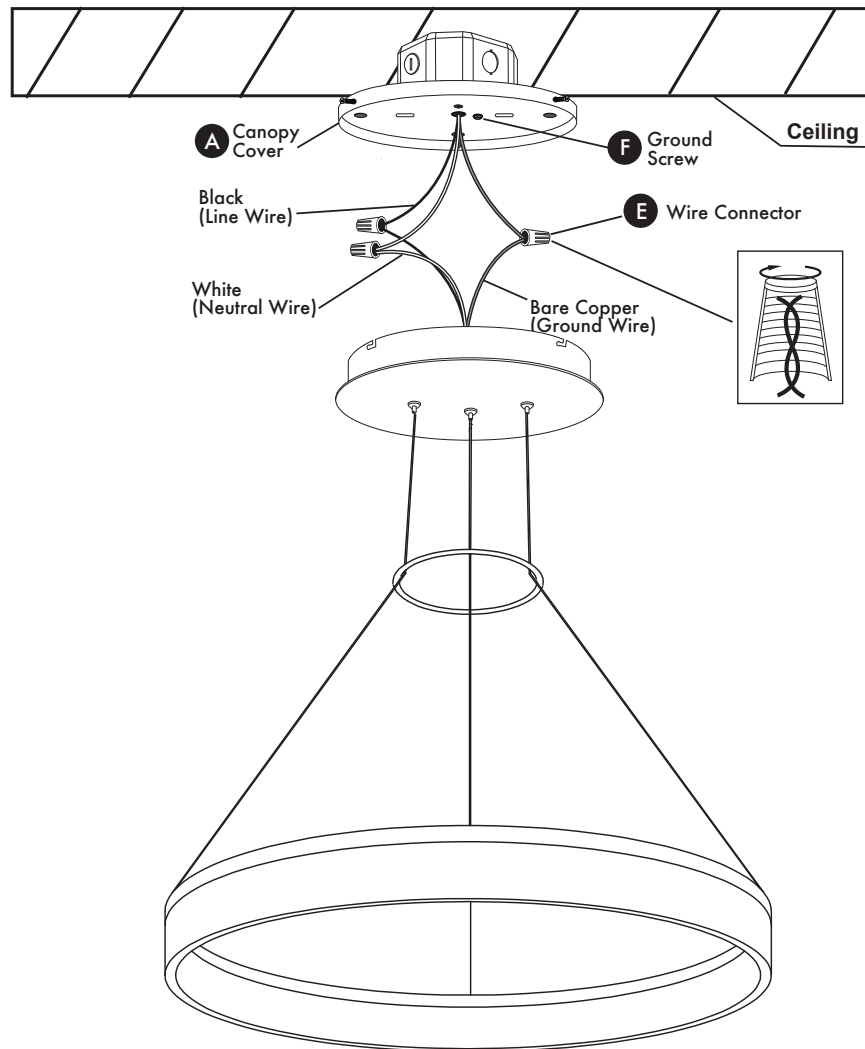

Supply Wires:

Connect Black (Line Wire) from fixture to Black (Hot Wire) from outlet box.

Connect White (Neutral Wire) from fixture to White (Neutral Wire) from outlet box.

Ground Wires:

Connect Bare Copper (Ground Wire) from fixture to Green or Bare Copper (Ground Wire) from outlet box.

Twist wires together clockwise and secure with wire connector (E).

Installer Tip (2): If ground wire is not available in outlet box, then secure Bare Copper (Ground Wire) from fixture to ground screw (F) on canopy cover (A).

Installer Tip (3): It is recommended that two installers are required to install the fixture. One installer to hold the fixture, and the second installer to connect the wires.

Step 4. Mount Fixture

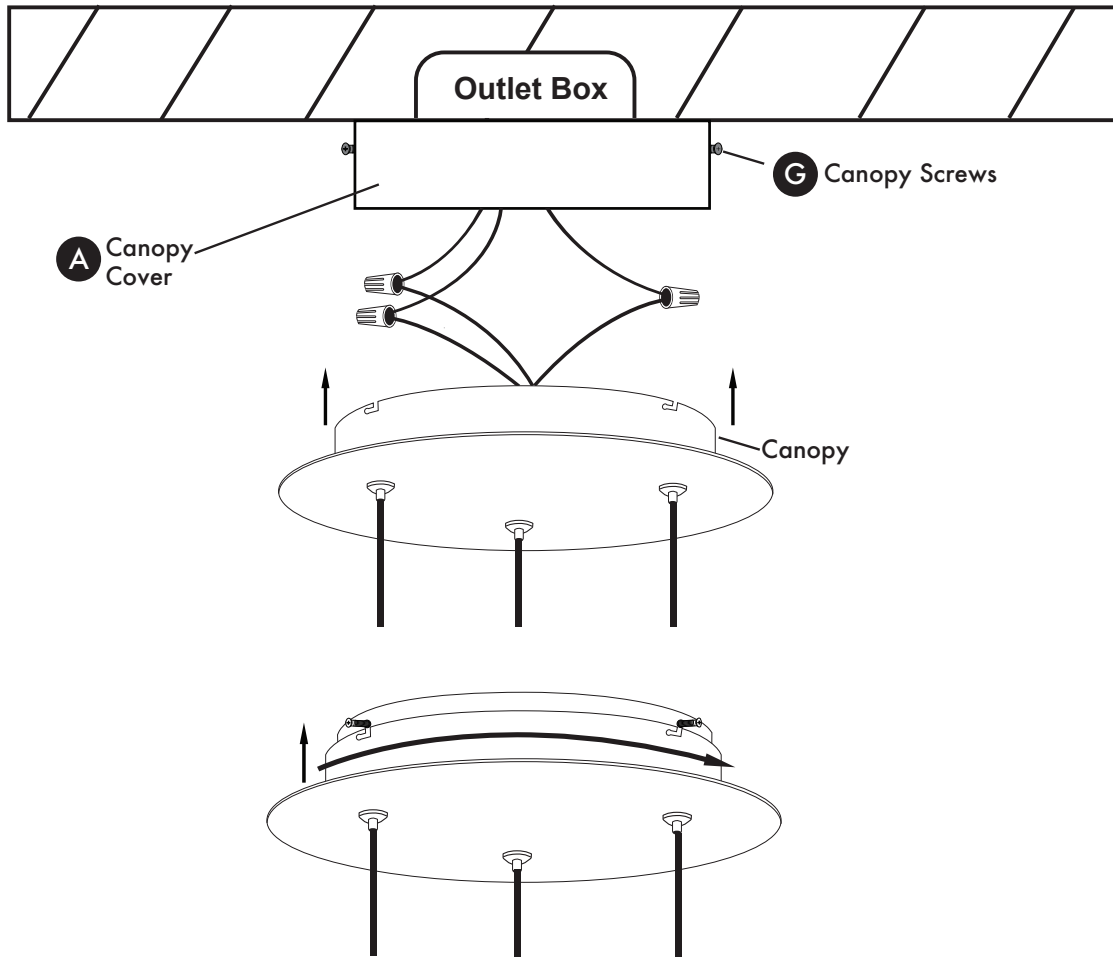

Attach canopy to canopy cover (A). Twist canopy to lock fixture in place. Secure canopy with canopy screws (G).

Step 5. Turn Power ON

Turn electricity "ON" at main fuse box.

Place the recommended ELV type dimmer switch in the "ON" position to test the fixture.

Circuit Box

