

Before returning this product call
1-800-4-DEWALT

IF YOU SHOULD EXPERIENCE A PROBLEM WITH YOUR DEWALT PURCHASE,

CALL 1-800-4 DEWALT

IN MOST CASES, A DEWALT REPRESENTATIVE CAN RESOLVE
YOUR PROBLEM OVER THE PHONE.

IF YOU HAVE A SUGGESTION OR COMMENT, GIVE US A CALL.
YOUR FEEDBACK IS VITAL TO THE SUCCESS OF DEWALT'S
QUALITY IMPROVEMENT PROGRAM.

Questions? See us on the World Wide Web at www.dewalt.com

**INSTRUCTION MANUAL
GUIDE D'UTILISATION
MANUAL DE INSTRUCCIONES**

INSTRUCTIVO DE OPERACIÓN, CENTROS DE SERVICIO Y
PÓLIZA DE GARANTÍA. **ADVERTENCIA:** LÉASE ESTE
INSTRUCTIVO ANTES DE USAR EL PRODUCTO.

DEWALT®

DC628

15 Gauge Cordless Nailer

Clouuse sans fil pour clou de calibre 15

Clavadora inalámbrica de calibre 15

Angled 34°

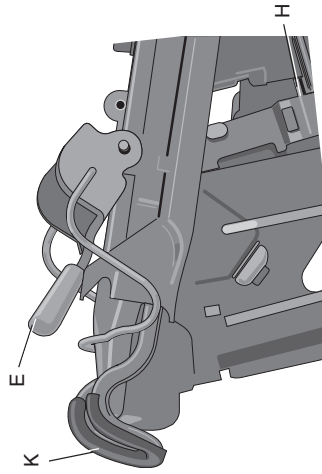
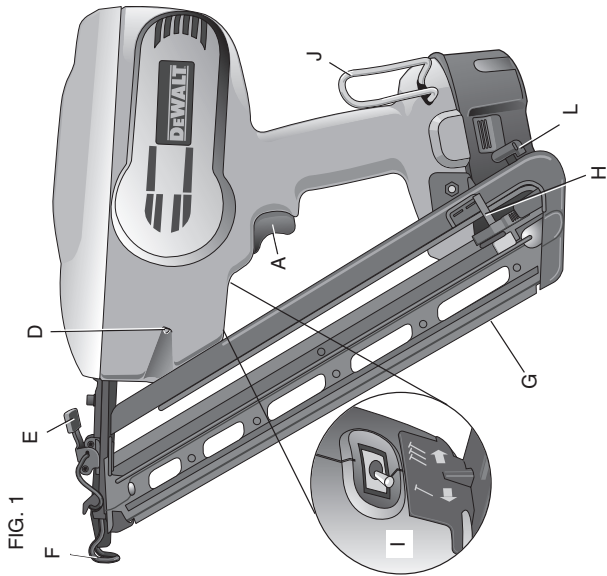

- A. Trigger
- B. Contact trip lock-off
- C. Depth adjustment wheel
- D. Headlights/Low battery indicator
- E. Jam clearing latch
- F. Contact trip
- G. Magazine
- H. Pusher
- I. Bump/sequential selector switch
- J. Reversible suspension hook
- K. No-mar pad
- L. No-mar tip storage

Definitions: Safety Guidelines
 The definitions below describe the level of severity for each signal word. Please read the manual and pay attention to these symbols.
▲ DANGER: Indicates an imminently hazardous situation which, if not avoided, **will result in death or serious injury.**
▲ WARNING: Indicates a potentially hazardous situation which, if not avoided, **could result in death or serious injury.**
▲ CAUTION: Indicates a potentially hazardous situation which, if not avoided, **may result in minor or moderate injury.**
CAUTION: Used without the safety alert symbol indicates a potentially hazardous situation which, if not avoided, **may result in property damage.**

TOOL SPECIFICATIONS

Firing Mode	Selective
Voltage	18
Height	12" (305 mm)
Width	5" (127 mm)
Length	14" (356 mm)
Weight	8.9 lbs. (4.07 kg)
Magazine Angle	34°
Loading Capacity	Up to 110 nails

NAIL SPECIFICATIONS

Nail Lengths	Angled 1-1/4", 1-1/2", 2", 2-1/2" (32 mm, 38 mm, 44 mm, 51 mm, 65 mm)
Shank Diameters	15 gauge
Nail Stick Angles	34°

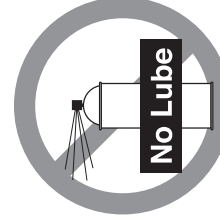

IF YOU HAVE ANY QUESTIONS OR COMMENTS ABOUT THIS OR ANY DEWALT TOOL, CALL US TOLL FREE AT: 1-800-4-DEWALT (1-800-433-9258)

General Safety Rules – For All Battery Operated Tools

WARNING! Read and understand all instructions. Failure to follow all instructions listed below may result in electric shock, fire and/or serious personal injury.

SAVE THESE INSTRUCTIONS

WORK AREA

- **Keep your work area clean and well lit.** Cluttered benches and dark areas invite accidents.
- **Do not operate power tools in explosive atmospheres, such as in the presence of flammable liquids, gases, or dust.** Power tools create sparks which may ignite the dust or fumes.
- **Keep bystanders, children, and visitors away while operating a power tool.** Distractions can cause you to lose control.

ELECTRICAL SAFETY

- **Do not abuse the cord. Never use the cord to carry the tool. Keep cord away from heat, oil, sharp edges or moving parts. Replace damaged cords immediately.** Damaged cords may create a fire.
- **A battery operated tool with integral batteries or a separate battery pack must be recharged only with the specified charger for the battery.** A charger that may be suitable for one type of battery may create a risk of fire when used with another battery.
- **Use battery operated tool only with the specifically designed battery pack.** Use of any other batteries may create a risk of fire.

PERSONAL SAFETY

- **Stay alert, watch what you are doing and use common sense when operating a power tool. Do not use tool while tired or under the influence of drugs, alcohol, or medication.** A moment of inattention while operating power tools may result in serious personal injury.
- **Dress properly. Do not wear loose clothing or jewelry. Contain long hair. Keep your hair, clothing, and gloves away from moving parts.** Loose clothing, jewelry, or long hair can be caught in moving parts. Air vents often cover moving parts and should also be avoided.
- **Avoid accidental starting. Be sure switch is in the locked or OFF position before inserting battery pack.** Carrying tools with your finger on the switch or inserting the battery pack into a tool with the switch on invites accidents. Be sure contact trip is also in the locked off position. This prevents nailer from accidental discharge.

FIG. A

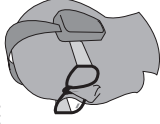

Important Safety Instructions for Nailers

WARNING: When using any nailer, all safety precautions, as outlined below, should be followed to avoid the risk of death or serious injury. Read and understand all instructions before operating the tool.

- **Hold tool by insulated gripping surfaces when performing an operation where the cutting tool may contact hidden wiring.** Contact with a "live" wire will make exposed metal parts of the tool "live" and shock the operator.

FIG. B



- **Actuating tool may result in flying debris, collation material, or dust which could harm operator's eyes.** Operator and others in work area MUST wear safety glasses with side shields. These safety glasses must conform to ANSI Z87.1 requirements (approved glasses have "Z87" printed or stamped on them. It is the employer's responsibility to enforce the use of eye protection equipment by the tool operator and other people in the work area. (Fig. A)

FIG. C

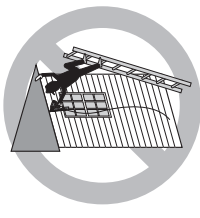

- **Always wear appropriate personal hearing and other protection during use.** Under some conditions and duration of use, noise from this product may contribute to hearing loss. (Fig. A)

FIG. D

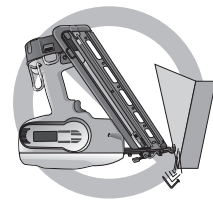

- **Disconnect battery pack from the tool when not in use. Always remove battery pack and remove fasteners from magazine before leaving the area or passing the tool to another operator. Do not carry tool to another work area in which changing location involves the use of scaffolding, stairs, ladders, and the like, with battery pack connected. Do not make adjustments, perform maintenance or clear jammed fasteners while battery is in place.**

FIG. E

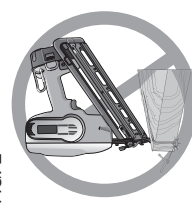

- **Do not remove, tamper with, or otherwise cause the tool, trigger, contact trip lock-off, or contact trip to become inoperable. Do not tape or tie trigger or contact trip in the ON position. Do not remove spring from contact trip. Make daily inspections for free movement of trigger and contact trip. Uncontrolled discharge could result.**

FIG. F

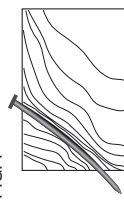

- **Inspect tool before use. Do not operate a tool if any portion of the tool, trigger, contact trip lock-off, or contact trip is inoperable, disconnected, altered, or not working properly.** Damaged parts or missing parts should be repaired or replaced before use. Refer to Repairs.

- **Remove adjusting keys or wrenches before turning the tool on.** A wrench or key that is left attached to a rotating part of the tool may result in personal injury.

- **Do not overreach. Keep proper footing and balance at all times.** Proper footing and balance enables better control of the tool in unexpected situations.

- **Use safety equipment. Always wear eye protection.** Dust mask, non-skid safety shoes, hard hat, or hearing protection must be used for appropriate conditions.

TOOL USE AND CARE

- **Use clamps or other practical way to secure and support the workpiece to a stable platform.** Holding the work by hand or against your body is unstable and may lead to a loss of control.

- **Do not force tool. Use the correct tool for your application.** The correct tool will do the job better and safer at the rate for which it is designed.

- **Do not use tool if switch does not turn it on or off.** Any tool that cannot be controlled with the switch is dangerous and must be repaired.

- **Disconnect battery pack from tool or place the switch in the locked or off position before making any adjustments, changing accessories, or storing the tool.** Such preventative safety measures reduce the risk of starting the tool accidentally.

- **Store idle tools out of reach of children and other untrained persons.** Tools are dangerous in the hands of untrained users.

- **When battery pack is not in use, keep it away from other metal objects like: paper clips, coins, keys, nails, screws, or other small metal objects that can make a connection from one terminal to another.** Shorting the battery terminals together may cause sparks, burns, or a fire.

- **Check for misalignment or binding of moving parts, breakage of parts, and any other condition that may affect the tool's operation. If damaged, have the tool serviced before using.** Many accidents are caused by poorly maintained tools.

- **Use only accessories that are recommended by the manufacturer for your model.** Accessories that may be suitable for one tool, may become hazardous when used on another tool.

SERVICE

- **Tool service must be performed only by qualified repair personnel.** Service or maintenance performed by unqualified personnel could result in a risk of injury.

- **When servicing a tool, use only identical replacement parts. Follow instructions in the Maintenance section of this manual.** Use of unauthorized parts or failure to follow Maintenance Instructions may create a risk of electric shock or injury.

- **Do not alter or modify the tool in any way.**
- **Always assume that the tool contains fasteners.**
- **Do not point the tool at co-workers or yourself at any time.** No horseplay! Work safely! Respect the tool as a working implement. (Fig. B)
- **Keep bystanders, children, and visitors away while operating a power tool.** Distractions can cause you to lose control. When tool is not in use, it should be locked in a safe place, out of the reach of children.
- **Always use contact trip lock-off when tool is not in immediate use.** Using the contact trip lock-off will prevent accidental discharge.
- **Do not overreach. Maintain proper footing and balance at all times.** Loss of balance may cause personal injury. (Fig. C)
- **Use the tool only for its intended use. Do not discharge fasteners into open air, concrete, stone, extremely hard woods, knots or any material too hard for the fastener to penetrate.** Do not use the body of the tool or top cap as a hammer. Discharged fasteners may follow unexpected path and cause injury. (Figs. D, F)
- **Do not use the body of the tool or top cap as a hammer.**
- **Always keep fingers clear of contact trip to prevent injury from inadvertent release of the pusher** (Fig. H)
- **Refer to the Maintenance and Repairs sections for detailed information on the proper maintenance of the tool.**
- **Always operate the tool in a clean, lighted area.** Be sure the work surface is clear of any debris and be careful not to lose footing when working in elevated environments such as rooftops.
- **Do not drive fasteners near edge of material.** The workpiece may split causing the fastener to ricochet, injuring you or a co-worker. Be aware that the nail may follow the grain of the wood (shiner), causing it to protrude unexpectedly from the side of the work material. Drive the chisel point of the nail perpendicular to the grain to reduce risk of injury. (Figs. E, F, M)
- **Do not drive nails onto the heads of other fasteners or with the tool at too steep an angle.** Personal injury from strong recoil, jammed fasteners, or ricocheted nails may result. (Fig. G)

FIG. G

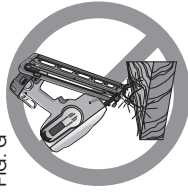

FIG. H

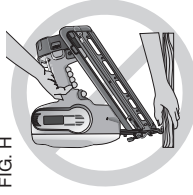

FIG. I



FIG. J

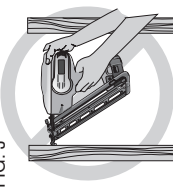

FIG. K

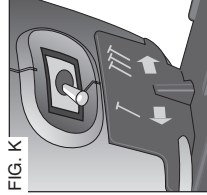
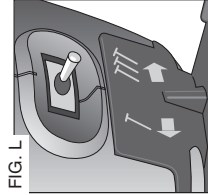

FIG. L



- **Keep hands and body parts clear of immediate work area.** Hold workpiece with clamps when necessary to keep hands and body out of potential harm. Be sure the workpiece is properly secured before pressing the nailer against the material. The contact trip may cause the work material to shift unexpectedly. (Fig. H)
 - **Do not use tool in the presence of flammable dust, gases or fumes.** The tool may produce a spark that could ignite gases causing a fire. Driving a nail into another nail may also cause a spark. (Fig. I)
 - **Keep face and body parts away from back of the tool cap when working in restricted areas.** Sudden recoil can result in impact to the body, especially when nailing into hard or dense material. (Fig. J)
 - **Grip tool firmly to maintain control while allowing tool to recoil away from work surface as fastener is driven.** In Bump mode if contact trip is allowed to recontact work surface before trigger is released an unwanted fastener will be fired.
 - **Choice of triggering method is important.** Check the manual for triggering options.
- ### BUMP/SEQUENTIAL SELECTOR SWITCH Sequential Action 7 (Fig. K)
- **When using the tool in sequential action, do not actuate the tool unless the tool is placed firmly against the workpiece**
- ### Bump Action 7 (Fig. L)
- **When using the tool in bump action, be careful of unintentional double fires resulting from tool recoil.** Unwanted fasteners may be driven if the contact trip is allowed to accidentally re-contact the work surface.
- ### TO AVOID DOUBLE FIRES:
- Do not engage the tool against the work surface with a strong force.
 - Allow the tool to recoil fully after each actuation.
 - Use sequential action trigger.
- **When "bump" actuating the finish nailer, always keep tool in control.** Inaccurate placement of tool can result in misdirected discharge of a fastener.
 - **Do not drive nails onto the heads of other fasteners.** Strong recoil, jammed fasteners, or ricocheted nails may result. (Fig. M)
 - **Be aware of material thickness when using nailer.** A protruding nail may cause injury.

FIG. M

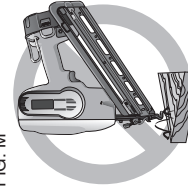

FIG. N

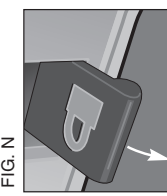

FIG. O



- **DEPTH ADJUSTMENT: To reduce risk of serious injury from accidental actuation when attempting to adjust depth, ALWAYS:**
 - Remove battery pack.
 - Engage contact trip lock-off (Fig. N).
 - Avoid contact with trigger during adjustments
 - **Do not drive nails blindly into walls, floors or other work areas.** Fasteners driven into live electrical wires, plumbing, or other types of obstructions can result in injury. (Fig. O)
 - **Stay alert, watch what you are doing and use common sense when operating a power tool. Do not use tool while tired or under the influence of drugs, alcohol, or medication.** A moment of inattention while operating power tools may result in serious personal injury.
- ⚠ WARNING:** Use of this product will expose you to chemicals known to the State of California to cause cancer, birth defects and other reproductive harm. **Avoid inhaling vapors and dust, and wash hands after using.**
- **Avoid prolonged contact with dust from power sanding, sawing, grinding, drilling, and other construction activities. Wear protective clothing and wash exposed areas with soap and water.** Allowing dust to get into your mouth, eyes, or lay on the skin may promote absorption of harmful chemicals.
- ⚠ WARNING:** Use of this tool can generate and/or disburse dust, which may cause serious and permanent respiratory or other injury. Always use NIOSH/OSHA approved respiratory protection appropriate for the dust exposure. Direct particles away from face and body.
- ⚠ WARNING:** ALWAYS USE SAFETY GLASSES. Everyday eye-glasses are NOT safety glasses. Also use face or dust mask if operation is dusty. ALWAYS WEAR CERTIFIED SAFETY EQUIPMENT:
- ANSI Z87.1 eye protection (CAN/CSA Z94.3),
 - ANSI S12.6 (S3.19) hearing protection,
 - NIOSH/OSHA/MSHA respiratory protection.
- ⚠ CAUTION: When not in use, place tool on its side on a stable surface where it will not cause a tripping or falling hazard.** Some tools with large battery packs will stand upright on the battery pack but may be easily knocked over.
- The label on your tool may include the following symbols. The symbols and their definitions are as follows:
- | | | | |
|-----|----------------------------|-----------|-----------------------------|
| V |volts | A |amperes |
| Hz |hertz | W |watts |
| min |minutes | ~ |alternating current |
| == |direct current | no |no load speed |
| ☐ |Class II Construction | ⊕ |earthing terminal |
| ▲ |safety alert symbol |/min |revolutions per minute |

BEFORE OPERATING THIS TOOL, CAREFULLY READ AND UNDERSTAND ALL INSTRUCTIONS IN THE "IMPORTANT SAFETY INSTRUCTIONS" SECTION.

Important Safety Instructions for Battery Packs

Your tool uses a DEWALT battery pack. When ordering replacement battery packs, be sure to include catalog number and voltage. Extended Run-Time battery packs deliver more run-time than standard battery packs. Consult the chart at the end of this manual for compatibility of chargers and battery packs.

NOTE: Your tool will accept either standard or Extended Run Time battery packs. However, be sure to select proper voltage. Batteries slowly lose their charge when they are not on the charger, the best place to keep your battery is on the charger at all times.

The battery pack is not fully charged out of the carton. Before using the battery pack and charger, read the safety instructions below. Then follow charging procedures outlined.

READ ALL INSTRUCTIONS

- **Do not incinerate the battery pack even if it is severely damaged or is completely worn out.** The battery pack can explode in a fire.
- **A small leakage of liquid from the battery pack cells may occur under extreme usage or temperature conditions.** This does not indicate a failure. However, if the outer seal is broken and this leakage gets on your skin:
 - a. Wash quickly with soap and water.
 - b. Neutralize with a mild acid such as lemon juice or vinegar.
 - c. If battery liquid gets into your eyes, flush them with clean water for a minimum of 10 minutes and seek immediate medical attention. (**Medical note:** The liquid is 25-35% solution of potassium hydroxide.)
- Charge the battery packs only in DEWALT chargers.
- **DO NOT splash or immerse in water or other liquids.**
- **Do not store or use the tool and battery pack in locations where the temperature may reach or exceed 105°F (such as outside sheds or metal buildings in summer).**

▲ DANGER: Electrocution hazard. Never attempt to open the battery pack for any reason. If battery pack case is cracked or damaged, do not insert into charger. Electric shock or electrocution may result. Damaged battery packs should be returned to service center for recycling.

NOTE: Battery storage and carrying caps are provided for use whenever the battery is out of the tool or charger. Remove cap before placing battery in charger or tool.

▲ WARNING: Fire hazard. Do not store or carry battery so that metal objects can contact exposed battery terminals. For example, do not place battery in aprons, pockets, tool boxes, product kit boxes, drawers, etc., with loose nails, screws, keys, etc.

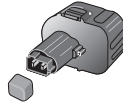

without battery cap. **Transporting batteries can possibly cause fires if the battery terminals inadvertently come in contact with conductive materials such as keys, coins, hand tools and the like.** The US Department of Transportation Hazardous Material Regulations (HMR) actually prohibit transporting batteries in commerce or on airplanes (i.e., packed in suitcases and carry-on luggage) **UNLESS they are properly protected from short circuits.** So when transporting individual batteries, make sure that the battery terminals are protected and well insulated from materials that could contact them and cause a short circuit.

▲ CAUTION: Battery pack must be securely attached to tool. If battery pack is detached, personal injury may result.

The RBRC™ Seal

The RBRC™ (Rechargeable Battery Recycling Corporation) Seal on the nickel cadmium and nickel metal hydride batteries (or battery packs) indicate that the costs to recycle these batteries (or battery packs) at the end of their useful life have already been paid by DEWALT. In some areas, it is illegal to place spent nickel cadmium and nickel metal hydride batteries in the trash or municipal solid waste stream and the RBRC program provides an environmentally conscious alternative.



RBRC™ in cooperation with DEWALT and other battery users, has established programs in the United States and Canada to facilitate the collection of spent nickel cadmium and nickel metal hydride batteries. Help protect our environment and conserve natural resources by returning the spent nickel cadmium and nickel metal hydride batteries to an authorized DEWALT service center or to your local retailer for recycling. You may also contact your local recycling center for information on where to drop off the spent battery.

RBRC™ is a registered trademark of the Rechargeable Battery Recycling Corporation.

Important Safety Instructions for Battery Chargers

SAVE THESE INSTRUCTIONS: This manual contains important safety instructions for battery chargers.

- Before using charger, read all instructions and cautionary markings on charger, battery pack, and product using battery pack.
- **▲ DANGER:** Electrocution hazard. 120 volts are present at charging terminals. Do not probe with conductive objects. Electric shock or electrocution may result.
- **▲ WARNING:** Shock hazard. Do not allow any liquid to get inside charger. Electric shock may result.
- **▲ CAUTION:** Burn hazard. To reduce the risk of injury, charge only DEWALT nickel cadmium rechargeable batteries. Other types of batteries may burst causing personal injury and damage.
- **▲ CAUTION:** Under certain conditions, with the charger plugged in to the power supply, the exposed charging con-

English

tacts inside the charger can be shorted by foreign material. Foreign materials of a conductive nature such as, but not limited to, steel wool, aluminum foil, or any buildup of metallic particles should be kept away from charger cavities. Always unplug the charger from the power supply when there is no battery pack in the cavity. Unplug charger before attempting to clean.

- **DO NOT attempt to charge the battery pack with any chargers other than the ones in this manual.** The charger and battery pack are specifically designed to work together.
- **These chargers are not intended for any uses other than charging DEWALT rechargeable batteries.** Any other uses may result in risk of fire, electric shock or electrocution.
- **Do not expose charger to rain or snow.**
- **Pull by plug rather than cord when disconnecting charger.** This will reduce risk of damage to electric plug and cord.
- **Make sure that cord is located so that it will not be stepped on, tripped over, or otherwise subjected to damage or stress.**
- **Do not use an extension cord unless it is absolutely necessary.** Use of improper extension cord could result in risk of fire, electric shock, or electrocution.
- **An extension cord must have adequate wire size (AWG or American Wire Gauge) for safety.** The smaller the gauge number of the wire, the greater the capacity of the cable, that is 16 gauge has more capacity than 18 gauge. When using more than one extension to make up the total length, be sure each individual extension contains at least the minimum wire size.

Recommended Minimum Wire Size for Extension Cords

Total Length of Cord	25 ft.	50 ft.	75 ft.	100 ft.	125 ft.	150 ft.	175 ft.
7.6 m	15.2 m	22.9 m	30.5 m	38.1 m	45.7 m	53.3 m	
Wire Size AWG	18	18	16	16	14	14	12

- **Do not place any object on top of charger or place the charger on a soft surface that might block the ventilation slots and result in excessive internal heat.** Place the charger in a position away from any heat source. The charger is ventilated through slots in the top and the bottom of the housing.
- **Do not operate charger with damaged cord or plug —** have them replaced immediately.
- **Do not operate charger if it has received a sharp blow, been dropped, or otherwise damaged in any way.** Take it to an authorized service center.
- **Do not disassemble charger; take it to an authorized service center when service or repair is required.** Incorrect reassembly may result in a risk of electric shock, electrocution or fire.

⚠ CAUTION: Never attempt to open the battery pack for any reason. If the plastic housing of the battery pack breaks or cracks, return to a service center for recycling.

Installing and Removing the Battery Pack

⚠ CAUTION: Engage contact trip lock-off before removing or installing battery.

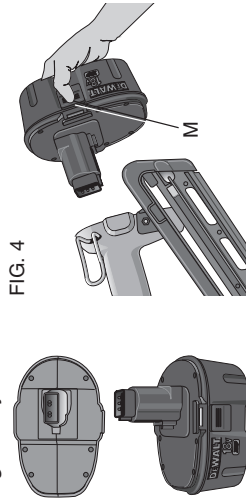
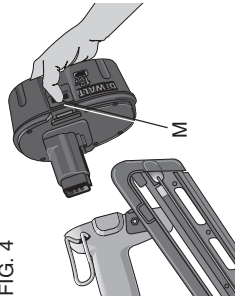

FIG. 3

FIG. 4



NOTE: Make sure your battery pack is fully charged.

To install the battery pack into the tool handle, align the base of the tool with the notch inside the tool's handle and slide the battery pack firmly into the handle until you hear the lock snap into place.

To remove the battery pack from the tool, press the release buttons (M) and firmly pull the battery pack out of the tool handle. Insert it into the charger as described in the charger manual (Fig. 4).

COMPONENTS

⚠ WARNING: Lock off trigger, disconnect battery pack from tool and remove fasteners from magazine before making adjustments or personal injury may result.

Refer to Figure 1 at the beginning of this manual for a complete list of components.

OPERATION

⚠ WARNING: Read the section titled **Important Safety Instructions for Nailers** at the beginning of this manual.

Always wear eye and ear protection when operating this tool. Keep the nailer pointed away from yourself and others. For safe operation, complete the following procedures and checks before each use of the nailer.

1. Wear proper eye, hearing and respiratory protection.
2. Lock the pusher in the back position and remove all fasteners from the magazine.
3. Check for smooth and proper operation of contact trip and pusher assemblies. Do not use tool if either assembly is not functioning properly. **NEVER** use a tool that has the contact trip restrained in the up position.
4. **NEVER** use a tool that has damaged parts.

⚠ WARNING: To reduce the risk of personal injury, disconnect battery pack from tool before performing maintenance, cleaning a jammed fastener, leaving work area, moving tool to another location or handing the tool to another person.

Mode Selection

⚠ WARNING: Always wear proper eye [ANSI Z87.1 (CAN/CSA Z94.3)] and ANSI S12.6 (S3.19) hearing protection when operating tool.

The DEWALT cordless nailers are assembled in accordance with the ANSI Standard SNT-101-2002.

Before operating this tool, look at the selector switch to determine the actuation mode. Read all instructions before selecting actuation mode.

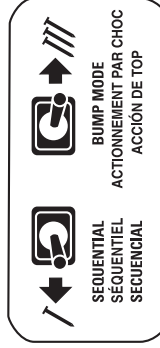

⚠ WARNING: Keep fingers **AWAY** from trigger when not driving fasteners to avoid accidental firing. **NEVER** carry tool with finger on trigger. In Bump mode tool will fire a fastener if safety is bumped while trigger is depressed.

SEQUENTIAL ACTION

Use sequential action for intermittent nailing where very careful and accurate placement is desired.

To operate the nailer in sequential action mode:

1. Flip the switch located on the body of the tool just between the trigger and magazine to the left, as shown in Figure 6.
2. Fully depress nosepiece against the work surface (motor will start).
3. Pull trigger (nail will drive into work surface).
4. Release trigger.
5. Lift nosepiece off work surface.
6. Repeat steps 2 through 4 for next application.

⚠ CAUTION: The contact trip needs to be depressed followed by a trigger pull for each nail followed by a release of both the contact trip and trigger after each nail.

BUMP ACTION

Bump action is intended for rapid nailing on flat, stationary surfaces.

When using bump action, two methods are available: **place actuation** and **bump actuation**.

Flip the switch located on the body of the tool just between the trigger and magazine to the right as shown in Figure 7.

To operate the tool using the PLACE ACTUATION method:

- ⚠ CAUTION:** A nail will fire each time the trigger is depressed as long as the contact trip remains depressed.
1. Depress the contact trip against the work surface.
 2. Depress the trigger.

To operate the tool using the BUMP ACTUATION method:

1. Depress the trigger.
2. Push the contact trip against the work surface. As long as the trigger is depressed, the tool will fire a nail every time the contact trip is depressed. This allows the user to drive multiple nails in sequence.

⚠ CAUTION: Do not keep trigger depressed when tool is not in use. Keep the contact trip lock-off engaged in the locked position when the tool is not in use.

Preparing the Tool

⚠ CAUTION: **NEVER** spray or in any other way apply lubricants or cleaning solvents inside the tool. This can seriously affect the life and performance of the tool.

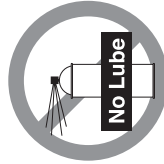

NOTE: The battery pack is not fully charged out of the carton. Follow instructions outlined (see **Charging Procedures**).

1. Read the **Safety Instruction** section of this manual.
2. Wear eye and ear protection.
3. Ensure magazine is empty of all fasteners.
4. Check for smooth and proper operation of contact trip and pusher assemblies. Do not use tool if either assembly is not functioning properly. **NEVER** use a tool that has the contact trip restrained in the actuated position.
5. Keep tool pointed away from yourself and others.
6. Insert fully charged battery pack.

Using the Contact Trip Lock-off (Fig. 8, 9)

⚠ WARNING: Do not keep trigger depressed when tool is not in use. Keep the lock-off switch rotated to the right (OFF) when the tool is not in use. Serious personal injury may result.

⚠ WARNING: Lock off trigger, disconnect battery pack from tool and remove fasteners from magazine before making adjustments. Serious personal injury may result.

Each DEWALT nailer is equipped with a contact trip lock-off (B) which when pulled downward with the lock symbol showing as shown, prevents the tool from firing a nail.

When the contact trip lock-off is folded in as shown, the tool will be fully operational. The contact trip lock-off should always be locked off whenever any adjustments are made or when tool is not in immediate use.

NOTE: Tools equipped with selective actuation, when in bump fire mode will allow the motor to start upon trigger pull. This is normal operation. The contact trip lock-off constrains the contact trip from discharging a nail.

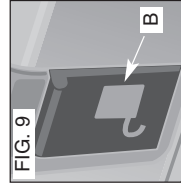
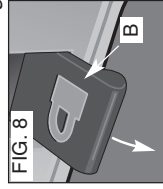

Loading the Tool

- ⚠ **WARNING:** Keep the tool pointed away from yourself and others. Serious personal injury may result.
- ⚠ **WARNING:** Never load nails with the contact trip or trigger activated. Personal injury may result.
- ⚠ **WARNING:** Always remove battery pack before loading or unloading nails. Serious personal injury may result.

LOAD AND DRAW METHOD (FIG. 1)

1. Insert fasteners into the rear of the magazine (G).
2. Pull pusher (H) back until the nail follower falls behind the nails.
3. Release the pusher.

LOCK AND LOAD METHOD

- ⚠ **CAUTION:** Keep fingers clear of pusher to prevent injury.
- ⚠ **CAUTION:** The contact trip lock-off should always be locked off whenever any adjustments are made or when tool is not in use.

1. Pull pusher back until it locks.
2. Insert fasteners into the rear of the magazine.
3. Push forward on the pusher until it releases and slides forward.

UNLOADING THE TOOL

- ⚠ **CAUTION:** The contact trip lock-off should always be locked off whenever any adjustments are made or when tool is not in use.

1. Pull pusher back until it locks.
2. Tip the tool up until the nails slide freely out the back of the magazine
3. Open the jam clear door on the nosepiece to verify there are no nails remaining.

Adjusting Depth (Fig. 10)

The depth that the fastener is driven can be adjusted using the depth adjustment wheel (C) on the side of the tool.

- ⚠ **WARNING:** To reduce risk of serious injury from accidental actuation when attempting to adjust depth, ALWAYS:

- Remove battery pack.
 - Engage contact trip lock-off.
 - Avoid contact with trigger during adjustments.
1. To drive the nail shallower, rotate the depth adjustment wheel (C) counterclockwise. There are six depth settings, 1 being the shallowest and 6 being the deepest.
 2. To sink a nail deeper, rotate the depth adjustment wheel (C) clockwise.

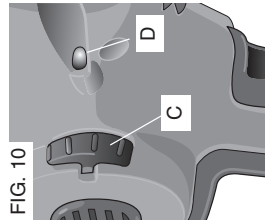
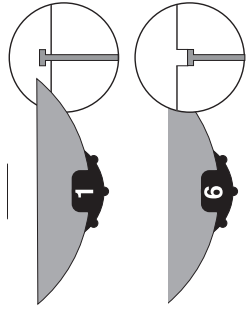

FIG. 10



Headlights (Fig. 10)

There is a headlight (D) located on each side of the nailer. Headlights turn on upon battery insertion, activation of the trigger, or depressing the contact trip. The lights will automatically shut off after 10 seconds unless tool remains in use.

NOTE: These headlights are for lighting the immediate work surface and are not intended to be used as flashlights.

LOW BATTERY INDICATOR: The headlights will flash four consecutive times and then shut down to indicate low battery.

LOW BATTERY..... ■■■■■■

JAMMED NAIL INDICATOR: The headlights will flash continually if a nail becomes jammed in the nosepiece (see **Clearing a Jammed Nail**).

JAMMED NAIL ■■■■■■

Clearing a Jammed Nail (Fig. 11)

If a nail becomes jammed in the nosepiece, keep the tool pointed away from you and follow these instructions to clear:

1. Remove battery pack from tool and engage contact trip lock-off.

2. Pull the pusher back until it locks in place then remove the nails.

3. Lift the jam clearing latch (E) then pull up to open front door (O).

4. Remove bent nail, using pliers if necessary.

5. If driver blade is in the down position, insert screwdriver or other rod into nosepiece and push driver blade back in position.

6. Close the front door and engage the wireform under the 2 arms (N) on the nosepiece.
7. Push latch until it locks in place.
8. Reinsert battery pack.

NOTE: The tool will disable itself and not reset until the battery pack has been removed and reinserted.

9. Reinsert nails into magazine (see **Loading the Tool**).
10. Release pusher.

NOTE: Should nails continue to jam frequently in nosepiece, have tool serviced by an authorized DEWALT service center.

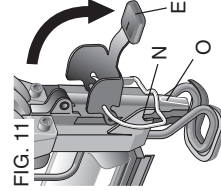

FIG. 11

Cold Weather Operation

When operating tools at temperatures below freezing:

1. Keep tool as warm as possible prior to use.
2. Actuate the tool 5 or 6 times into scrap lumber before using.

Hot Weather Operation

Tool should operate normally. However, keep tool out of direct sunlight as excessive heat can deteriorate bumpers and other rubber parts resulting in increased maintenance.

Suspension Hook (Fig. 12)

The DEWALT cordless nailers include an integrated suspension hook (J) and can be attached to either side of the tool to accommodate left- or right-handed users.

If the hook is not desired at all, it can be removed from the tool.

TO REMOVE SUSPENSION HOOK

1. Remove battery pack from tool.
2. To switch the tool from right- to left-hand usage simply remove the screw from the opposite side of the tool and reassemble on the other side.
3. Replace battery pack.

⚠ **WARNING:** Remove nails from magazine before making any adjustments or servicing this tool. Failure to do so may result in serious injury.

⚠ **CAUTION:** Disconnect battery pack from tool before making any adjustments, changing accessories, servicing, or moving the tool. Such preventative safety measures reduce the risk of starting the tool accidentally.

⚠ **CAUTION:** When not in use, place tool on its side on a stable surface where it will not cause a tripping or falling hazard. Some tools with large battery packs will stand upright on the battery pack but may be easily knocked over.

MAINTENANCE

⚠ **WARNING:** Disconnect battery pack from tool before cleaning and inspection. Make sure tool is in proper working condition before placing the tool back in use or serious personal injury may result.

Daily Maintenance Chart

ACTION	Clean magazine, pusher, and contact trip mechanism.
WHY	Permits smooth operation of magazine, reduces wear, and prevents jams.
HOW	The use of oils, lubricants periodically or solvents is not recommended as they tend to attract debris.
ACTION	Before each use, check to insure all screws, nuts and fasteners are tight and undamaged.
WHY	Prevents jams and premature failure of tool parts.
HOW	Tighten loose screws or other fasteners using the appropriate Allen wrench or screwdriver.

Cleaning

⚠ CAUTION: When cleaning, use only a damp cloth on plastic parts. Many household cleaners contain chemicals which could seriously damage plastic parts. Also, do not use gasoline, turpentine, lacquer or paint thinner, dry cleaning fluids or similar products which may seriously damage plastic parts. Never let any liquid get inside the tool; never immerse any part of the tool into a liquid.

CHARGER CLEANING INSTRUCTIONS

⚠ WARNING: Disconnect the charger from the AC outlet before cleaning. Dirt and grease may be removed from the exterior of the charger using a cloth or soft non-metallic brush. Do not use water or any cleaning solutions.

Lubrication

⚠ CAUTION: NEVER spray or in any other way apply lubricants or cleaning solvents inside the tool. This can seriously affect the life and performance of the tool.

DEWALT tools are properly lubricated at the factory and are ready for use. However, it is recommended that, once a year, you take or send the tool to a certified service center for a thorough cleaning and inspection.

Repairs

To assure product SAFETY and RELIABILITY, repairs, maintenance and adjustment (including brush inspection and replacement) should be performed by a DEWALT factory service center, a DEWALT authorized service center or other qualified service personnel. Always use identical replacement parts. Refer to the **Troubleshooting Guide** at the end of this section.

⚠ WARNING: Disconnect battery pack from tool before making any adjustments, changing accessories, servicing, or moving the tool. Such preventative safety measures reduce the risk of starting the tool accidentally.

⚠ WARNING: Remove nails from magazine before making any adjustments or servicing this tool. Failure to do so may result in serious injury.

TO SERVICE

1. Remove 3 T25 slotted screws from top cover. Remove cover from housing and set aside.
2. Using a nail or punch, apply pressure to the pin (Q) sliding the pin out from the metal structure (Fig. 13).

FIG. 13

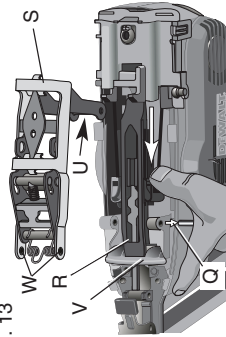

3. Push driver/return assembly (R) toward nosepiece and hold in place against the lower bumper (V) as you roll back the activation arm Assembly (S). Remove activation arm assembly and set aside.

4. Use a flat blade screwdriver to pry up on the return cord assembly (T) until the detents release. Lift up to remove (Fig. 14).

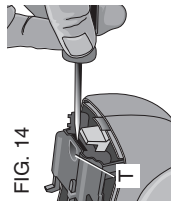

FIG. 14



FIG. 15

DRIVER/RETURN ASSEMBLY
Available by calling
1-800-4-DEWALT

5. Remove the driver/return assembly (Fig. 15).

6. Inspect lower bumper (V), upper bumper (X), and other surfaces for cracks or damage and replace if necessary (Fig. 16). Replace damaged return cord assembly.

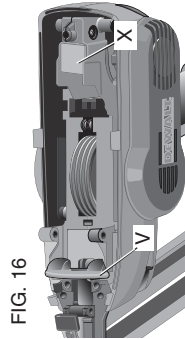

FIG. 16

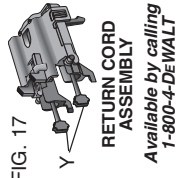

FIG. 17

RETURN CORD ASSEMBLY
Available by calling
1-800-4-DEWALT

TO REPLACE RETURN CORD ASSEMBLY

NOTE: For correct cord position during assembly, refer to the proper orientation of the return cord assembly in Figure 15.

1. Align one of the rubber tabs (Y) from the new return cord assembly with the corresponding slot in the driver (Fig. 18).
2. With your finger, push and bend the rubber tab around corner (Fig. 18) while pulling the rubber cord until tab is firmly in place (Fig. 19).

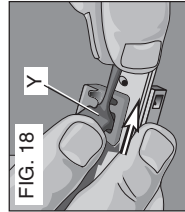

FIG. 18

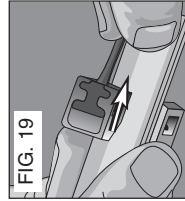

FIG. 19

3. Repeat above procedure for other rubber cord.

TO REASSEMBLE NAILER

1. Insert the tip of the driver/return assembly blade into the matching hole in the nosepiece (Fig. 20).

English

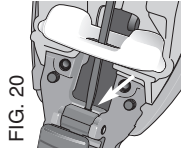

FIG. 20

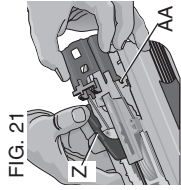

FIG. 21

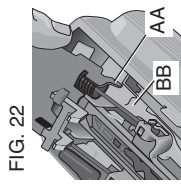

FIG. 22

2. Move contact trip (Z) to the side while pulling back on the return cord assembly (Fig. 21).

3. Engage the hooks (AA) on the return cord assembly to the notch (BB) in the metal structure then push down to snap into detents (Fig. 22).

4. Slide the driver/return assembly (R) toward the nose-piece and hold.

5. Insert activation arm assembly by first engaging the cam pin (U) to the solenoid; then align the pivot holes (W) to the metal structure (Fig. 13).

6. Slide the pin (Q) through the metal structure, capturing the activation arm assembly and spring.

7. Ensure the activation arm is fully engaged as shown in Figure 23.

8. Replace the cover to housing, insert 3 T25 slotted screws and tighten.

FIG. 23

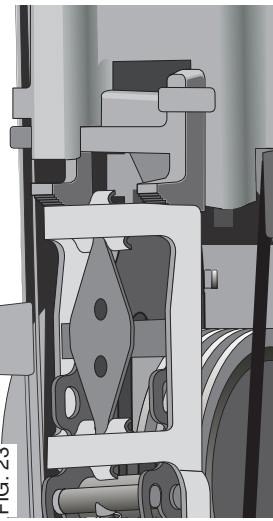

Accessories

⚠ WARNING: Since accessories, other than those offered by DEWALT, have not been tested with this product, use of such accessories with this tool could be hazardous. To reduce the risk of injury, only DEWALT, recommended accessories should be used with this product.

Recommended accessories for use with your tool are available at extra cost from your local dealer or authorized service center. If you need assistance in locating any accessory, please contact DEWALT Industrial Tool Co., 701 East Joppa Road, Baltimore, MD 21286, call 1-800-4-DEWALT (1-800-433-9258) or visit our website www.dewalt.com.

Three Year Limited Warranty

DEWALT will repair, without charge, any defects due to faulty materials or workmanship for three years from the date of purchase. This warranty does not cover part failure due to normal wear or tool abuse. For further detail of warranty

TROUBLESHOOTING GUIDE

MANY COMMON PROBLEMS CAN BE SOLVED EASILY BY UTILIZING THE CHART BELOW. FOR MORE SERIOUS OR PERSISTENT PROBLEMS, CONTACT A DEWALT SERVICE CENTER OR CALL 1-(800)-4-DEWALT.

▲ WARNING: TO REDUCE THE RISK OF SERIOUS PERSONAL INJURY, ALWAYS DISCONNECT BATTERY PACK FROM TOOL BEFORE ALL REPAIRS

SYMPTOM	CAUSE	FIX
Tool doesn't turn on (Headlights don't turn on)	Low battery charge or damaged battery Terminals are dirty or damaged Contact trip lock is in a locked position Bent contact trip Tool internal electronics not reset Damaged internal electronics	Charge or replace battery See authorized service center Unlock contact trip lock See authorized service center Remove battery, wait 3 seconds and reinsert See authorized service center
Tool doesn't actuate (Headlights on, motor does not run)	Motor stops running after 2 seconds Contact trip or trigger not depressed Damaged trigger Bent contact trip Contact trip lock in the locked position (Sequential mode only) Damaged internal electronics	Normal operation; release trigger or contact trip and redepess See instruction manual See authorized service center See authorized service center Unlock contact trip lock See authorized service center
Tool doesn't actuate (Headlights flash 4 times)	Low battery charge or damaged battery	Charge or replace battery
Tool doesn't actuate	Jammed fastener	Remove the battery, clear the jammed fastener. (push driver blade back up manually if necessary) and reinsert battery pack See authorized service center
Tool doesn't actuate	Jammed mechanism	See authorized service center
Tool doesn't actuate (Headlights on, motor runs)	Damaged internal electronics	See authorized service center
Tool doesn't actuate (Headlights on, motor runs, driver blade stuck down)	Damaged return system Debris in nosepiece Damaged driver/return assembly	Replace return system; see authorized service center Clean nosepiece Replace driver/return assembly; see authorized service center
Tool operates, but does not drive the fastener fully	Low battery charge or damaged battery Depth adjustment set too shallow Tool not firmly applied to workpiece Material and fastener length too rigorous an application Damaged or worn driver blade tip Damaged or worn driver/return assembly	Charge or replace battery Rotate depth adjustment wheel to a deeper setting See instruction manual Choose appropriate material or fastener length Replace driver/return assembly; see authorized service center Replace driver/return assembly; see authorized service center
Tool operates, but no fastener driven	No fasteners in magazine Wrong size or angle fasteners Debris in nosepiece Debris in magazine Worn magazine Damaged or worn driver blade Damaged pusher spring	Load fasteners into magazine Use only recommended fasteners Clean nosepiece Clean magazine Replace magazine; see authorized service center Replace driver/return assembly; see authorized service center Replace spring; see authorized service center
Jammed fastener	Wrong size or angle fasteners Damaged or worn driver blade Material and fastener length too rigorous an application Low battery charge or damaged battery Debris in nosepiece Debris in magazine Worn magazine Worn or damaged pusher spring	Use only recommended fasteners Replace driver/return assembly; see authorized service center Material or fastener length inappropriate Charge or replace battery Clean nosepiece Clean magazine Replace magazine; see authorized service center Replace spring; see authorized service center