

INSTRUCTION MANUAL

Model: A25



ATTENTION

Thank you very much for your purchase. When the number of your order is more than 1, we will split your order and ship the goods separately to ensure the safety.



Scan the code to watch the installation video.

PARTS LIST



01

HARDWARE LIST

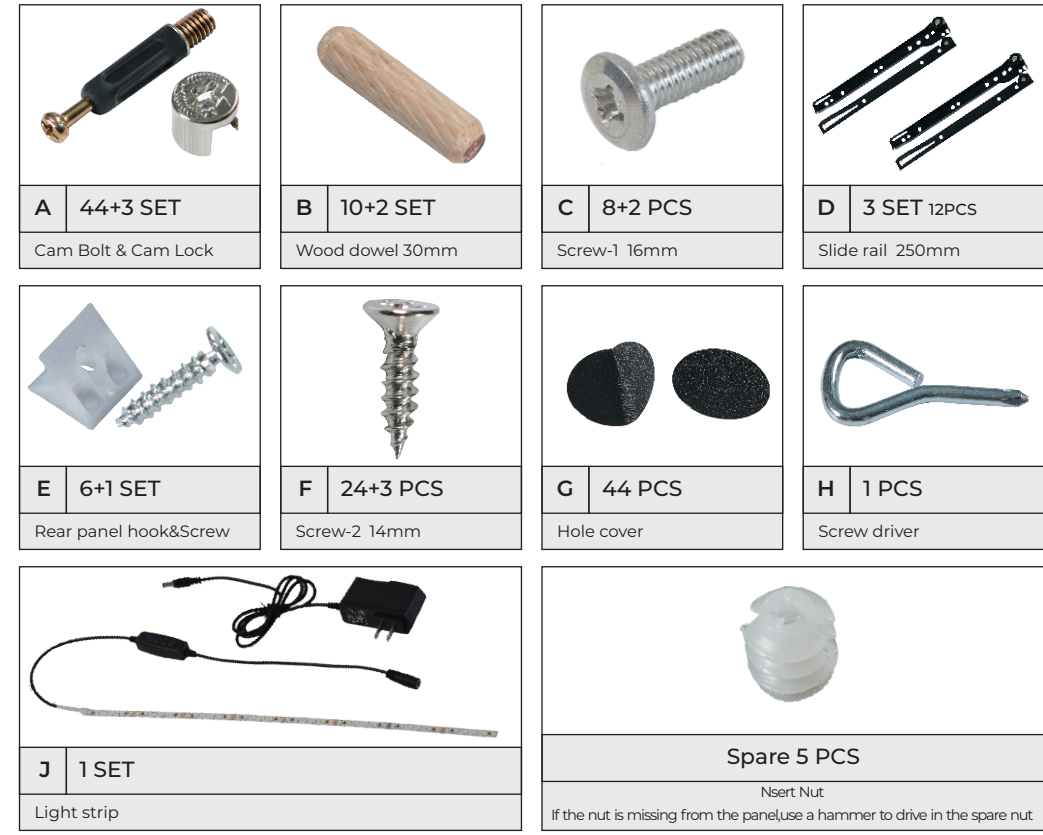

ATTENTION

1. Please place the product on the carpet or carton to assemble to avoid scratching the floor;
2. During the installation process, keep away from children and pets and avoid accidentally swallowing spare parts;
3. It is recommended to use a low-speed electric drill for installation.

02

step 1.

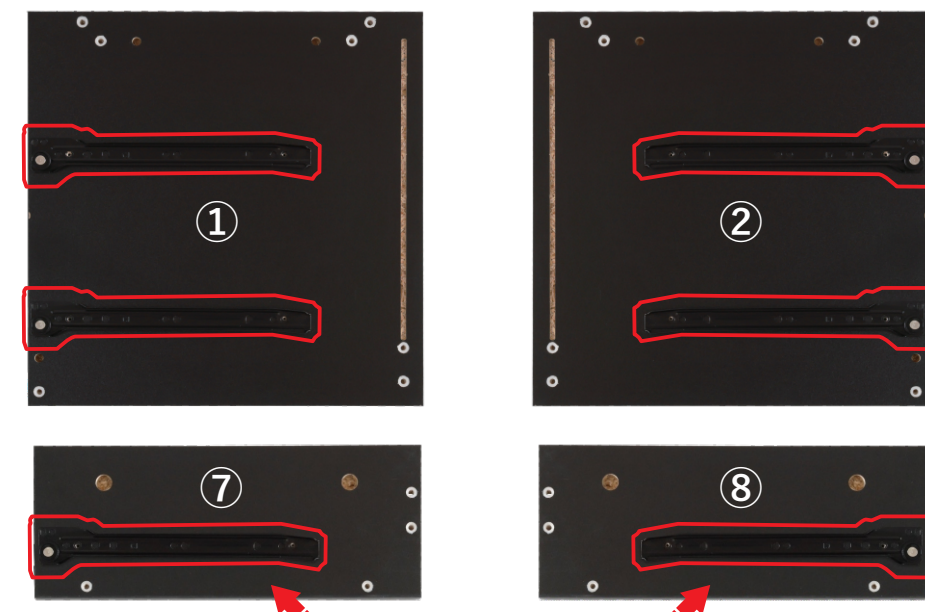

Please check the direction of each slide first!
Please carefully review the red markings on the slide rails in the manual!

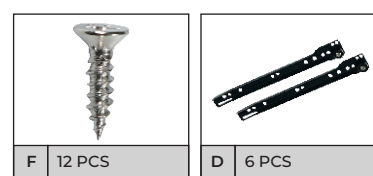

03

step 2.

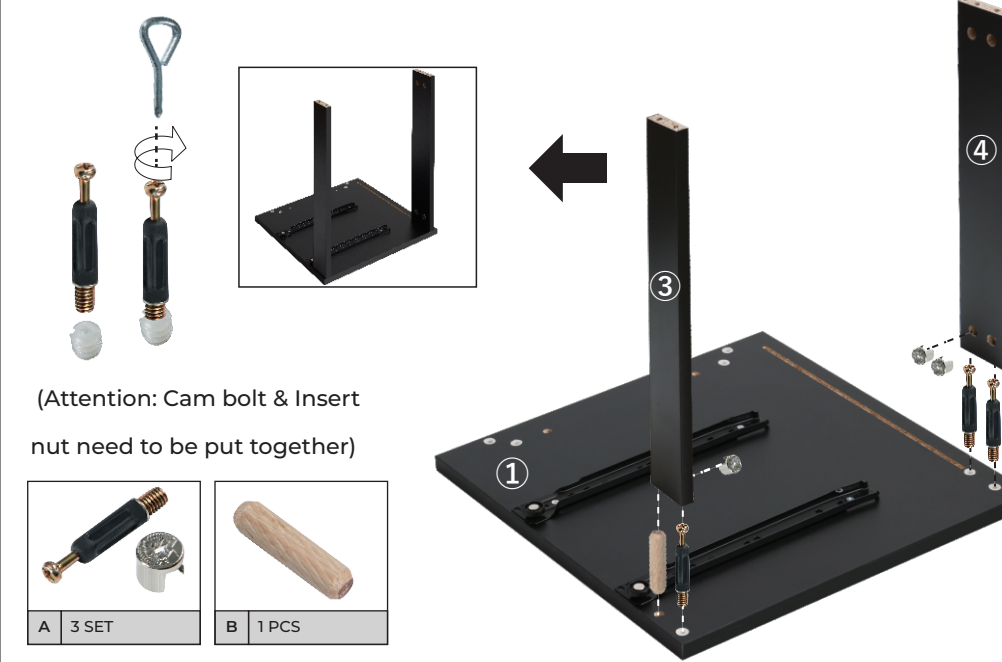

step 3.

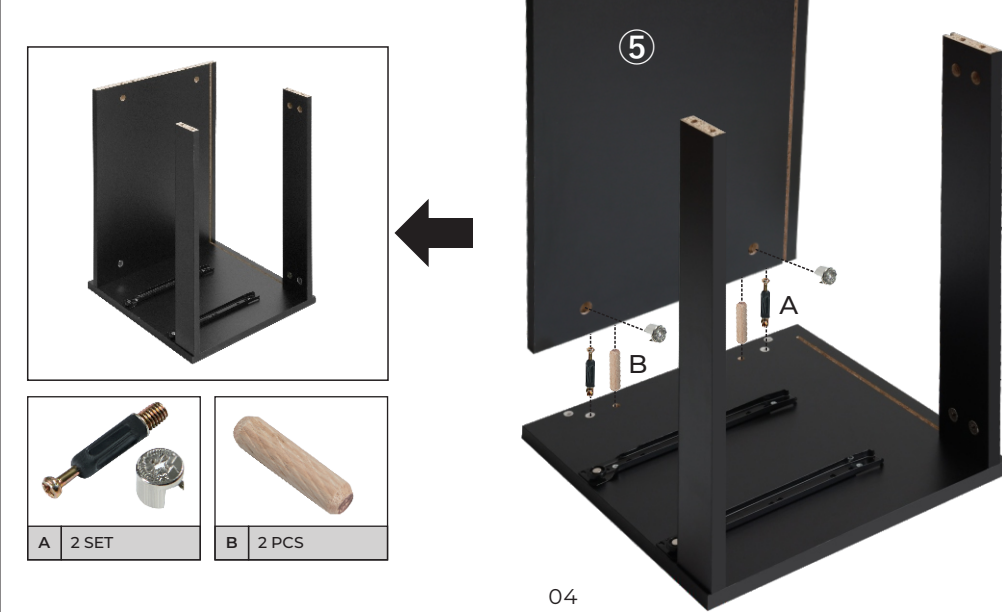

04

step 4.

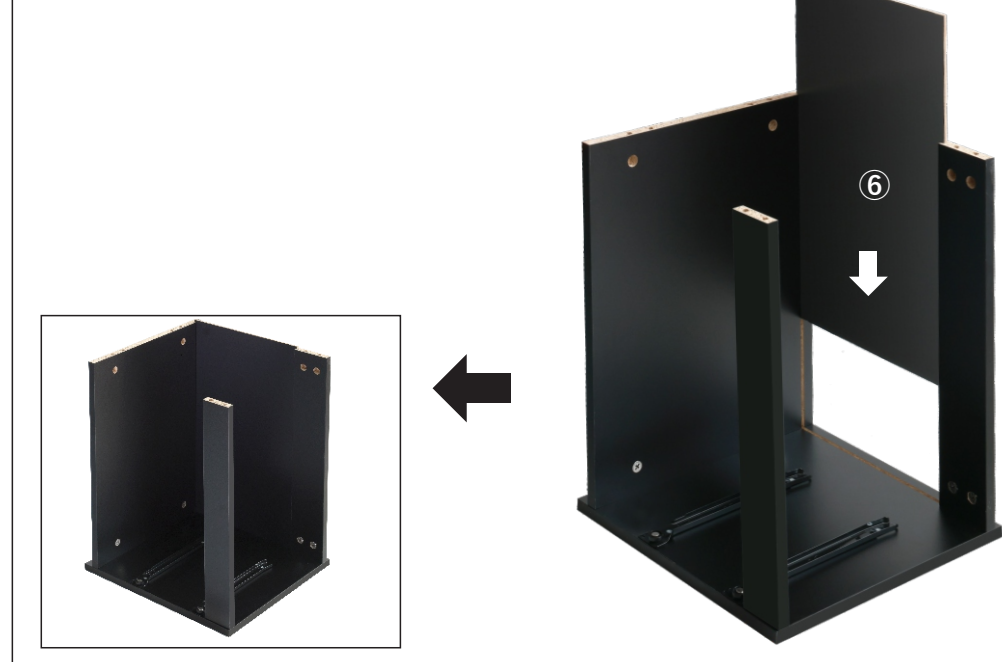

step 5.



05

step 6.

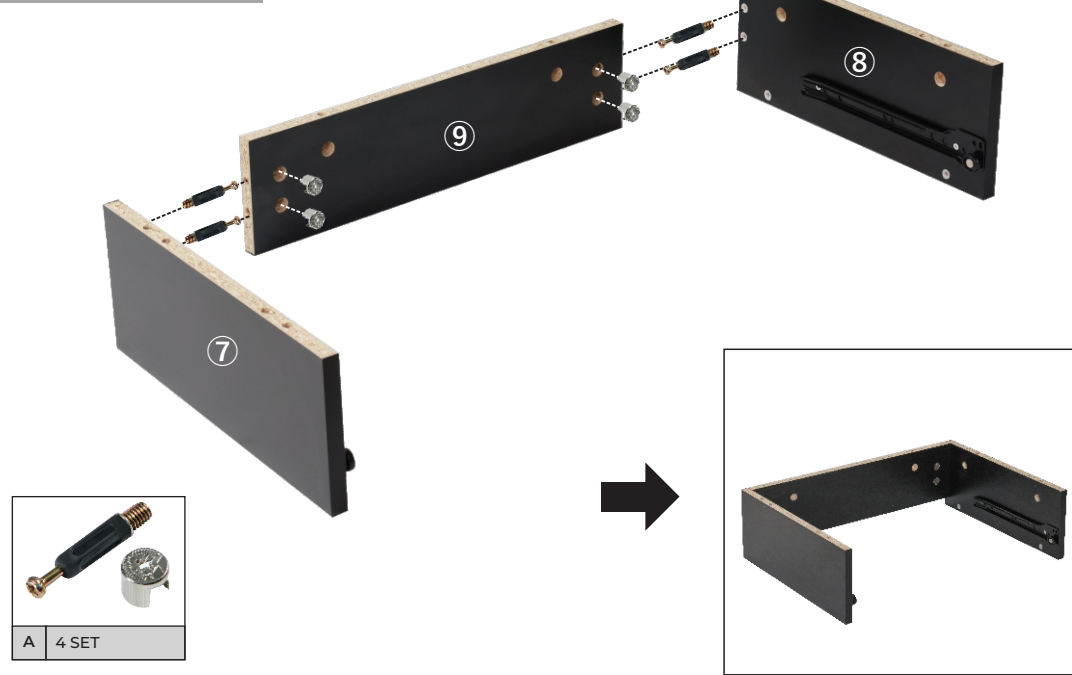

step 7.

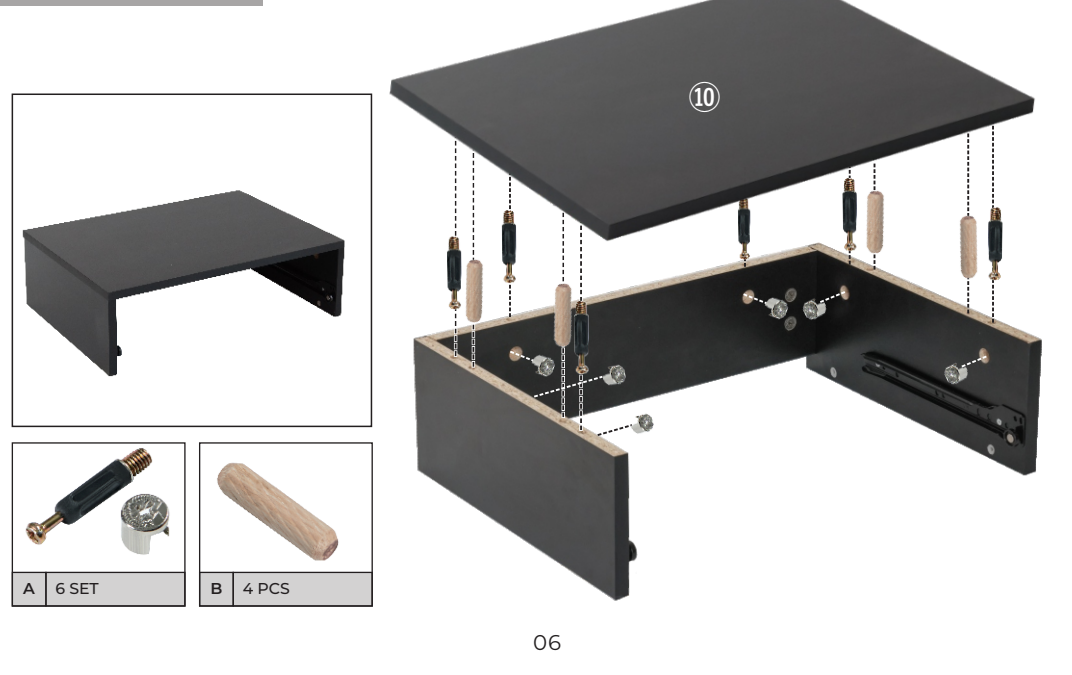

06

step 8.

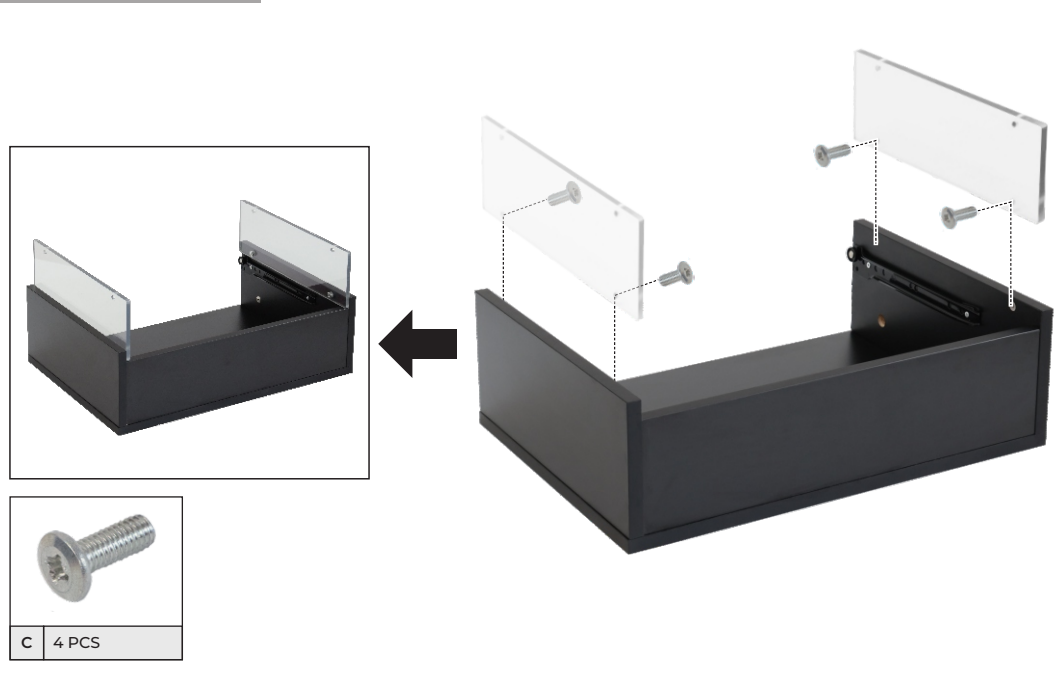

step 9.



07

step 10. x3

DRAWER INSTALLATION

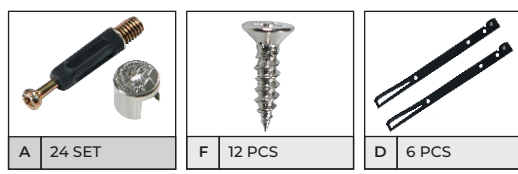
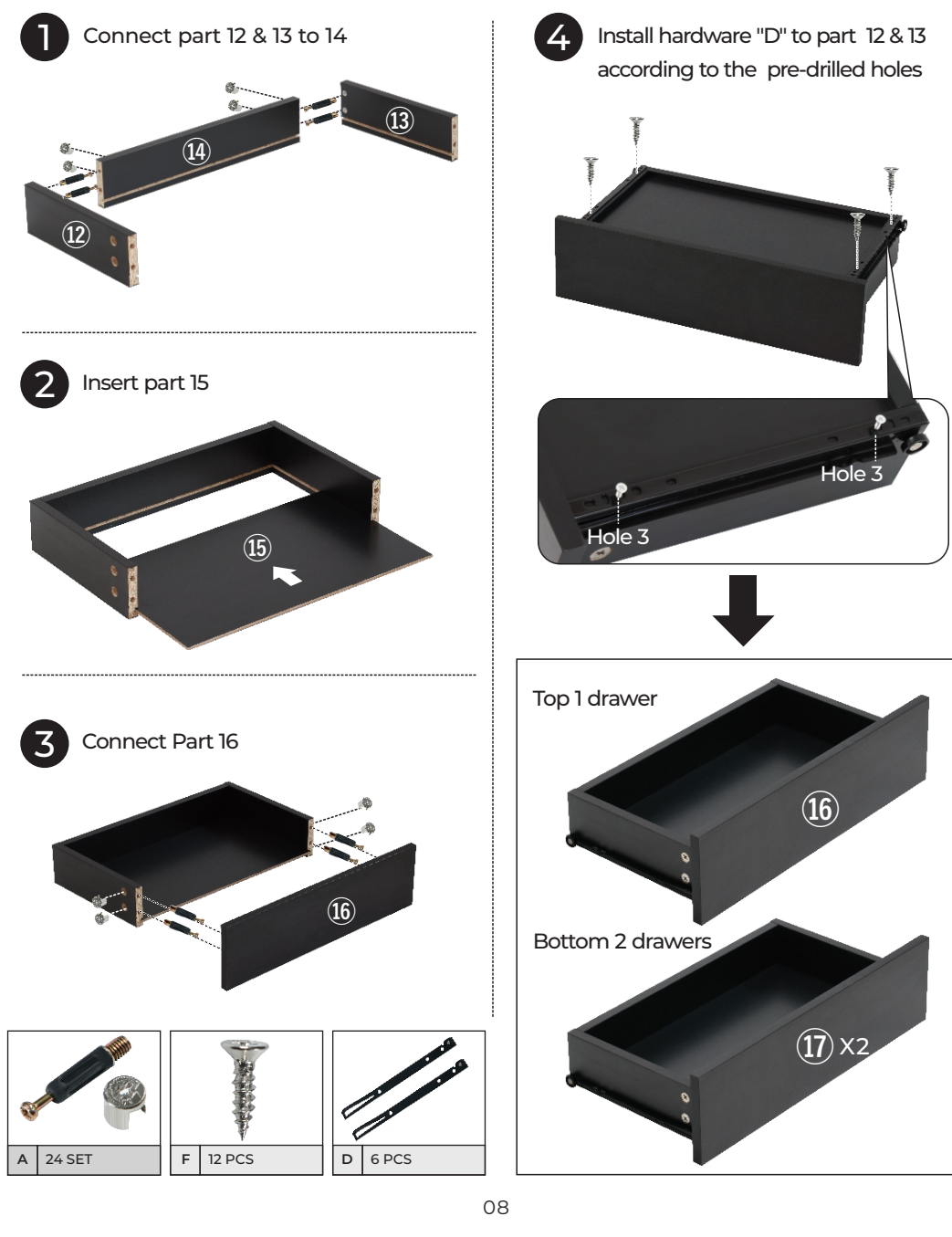

08

step 11.

Paste the light strip inside the 9th back panel for testing. You can choose to paste it from left to right or from right to left.
Note: If the light strip is not pasted correctly, it should be gently removed and avoid using too much force to prevent the lightstrip from breaking. If the light strip is not on or damaged, please contact the online seller in a timely manner.

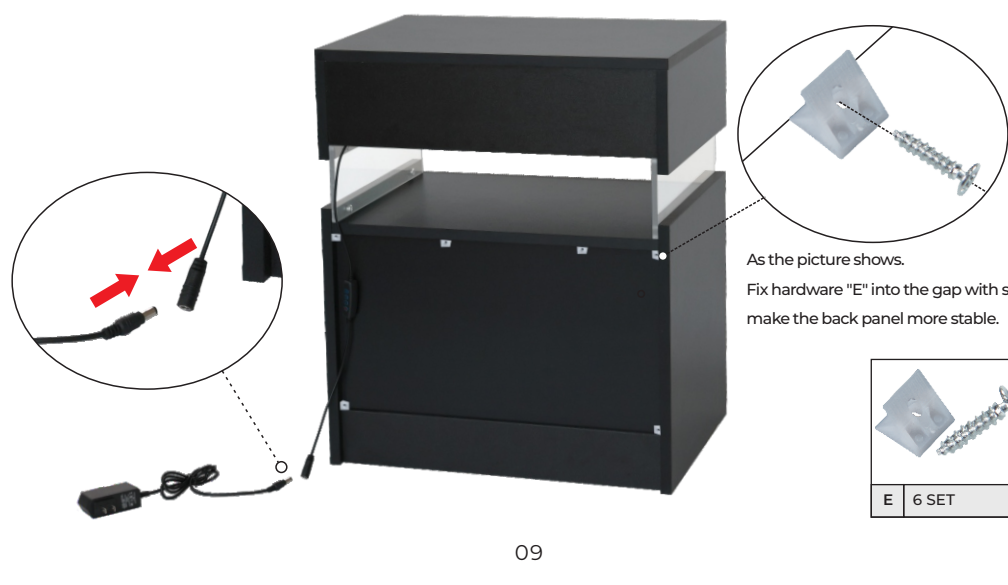
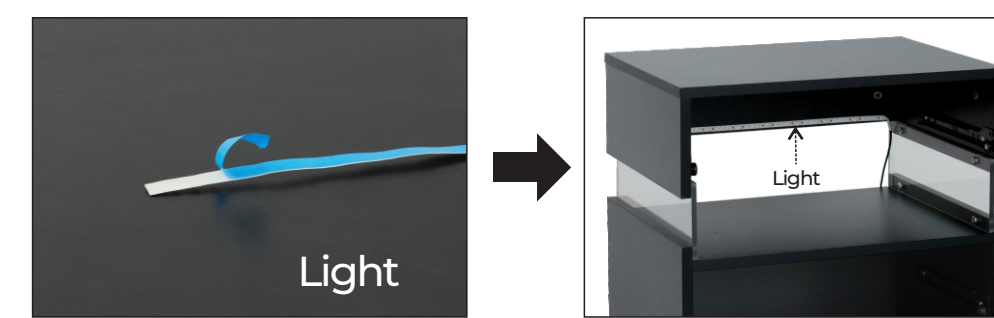

09

step 12.

Please stick the hardware "G" on the exposed cam lock hole that makes your product more beautiful.

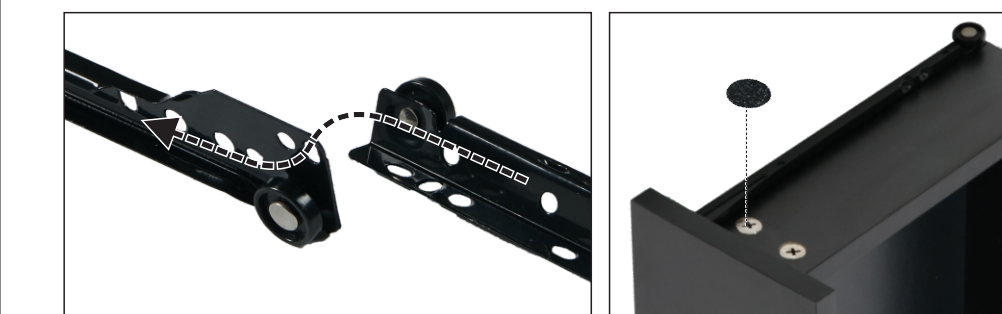

10



Congratulations on successful installation!!!

THANK YOU VERY MUCH FOR YOUR PURCHASE.
Customer service email: info@i-plus.com