











# Assembly Instructions

**Caution : You must read this before you proceed**

## Care & Maintenance

- ⊘  ● Not for commercial use. For residential use only.
- ⊘  ● Prolonged exposure to rain may cause rusting which can stain floors.
- ⊘  ● Do not put hot items directly on furniture surface.
- ⊘  ● Do not clean furniture with harsh cleansers or polish.
- ✓  ● To obtain the longest lifespan of your outdoor products, minimizing exposure to direct sunlight is recommended.
- ⊘  ● Children should not climb or jump on the furniture.
- ⊘  ● Do not write on furniture without a padded barrier to protect the surface.
- ✓  ● To obtain the longest lifespan of your outdoor products, avoid extended and lengthy exposure to rain, snow, and direct sunshine. Whenever possible cover the product and /or place under patio or awnings.
- ⊘  ● Stains may be removed with mild soap solution and damp cloth.
- ✓  ● Keep away from sources of ignition.
- ✓  ● Dust and pick-up spills using a clean, non-colored, lint-free cloth.



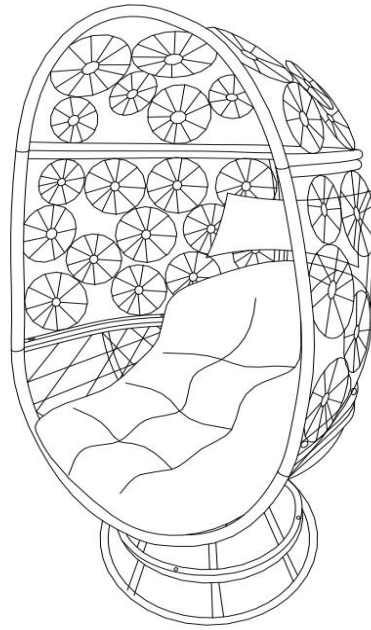

**Please look in Chair for hardware packs and legs.  
Sets often ship in multiple boxes and may arrive a day or two apart.**

# Chair







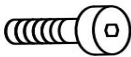

## Parts List

Label	Picture	Description	QTY
A		Turn Plate	1
B		Round Base	1
C		Seat Part	1
D		Left Part	1

E		Right Part	1
F		Top Part	1
G		Cushion	1
H		Pilllow	1

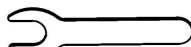
## Hardware

Label	Picture	Description	QTY
①		Bolt (M6*45mm)	18
②		Bolt (M6*15mm)	5
③		Washer M6	39
④		Nut M6	18
⑤		Allen Wrench S4	1
⑥		Spanner M10	1
⑦		Nut Cap	18

# Assembly Preparation

Before Beginning Assembly :

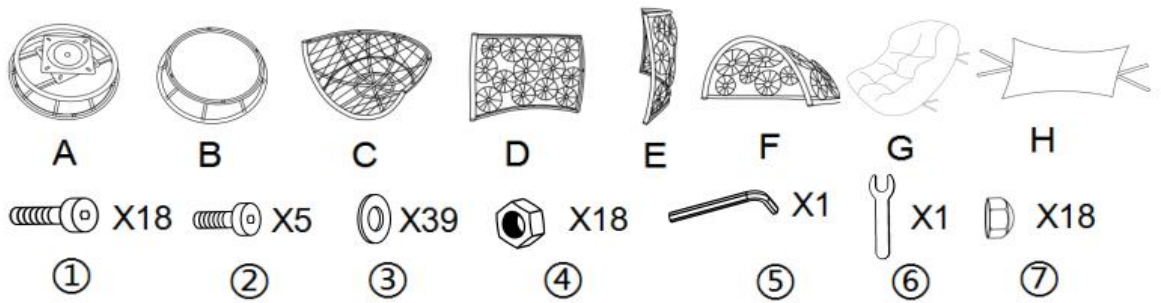

- Read instructions, cover to cover-



- Have 2 adults on hand for assembly-



- Do not assemble on flooring or carpet-



- Assemble on a clean non-marring surface (packing foam)-



- Save all packaging until finished-

# Assembly Steps

## Overview

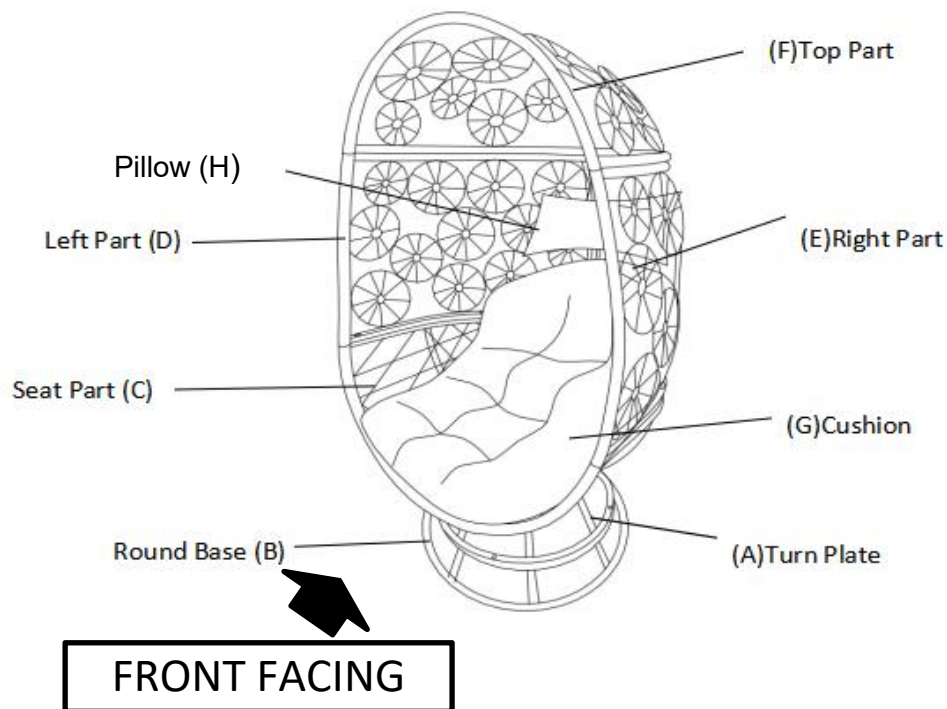

This Chair has multiple parts and may require up to 30 minutes to assemble. To give you an overview of the various parts, the above picture is to help you put the various parts into perspective. Please read through the instructions below to familiarise yourself with the parts and steps before assembly.

## Step 1

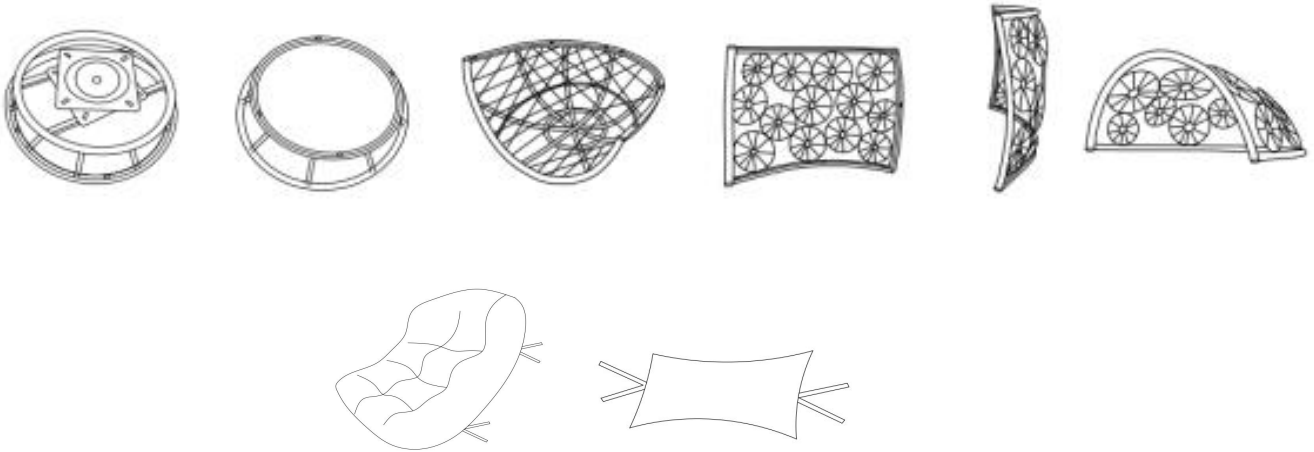

Unpack and place all parts on a clean, soft surface.

## Step 2

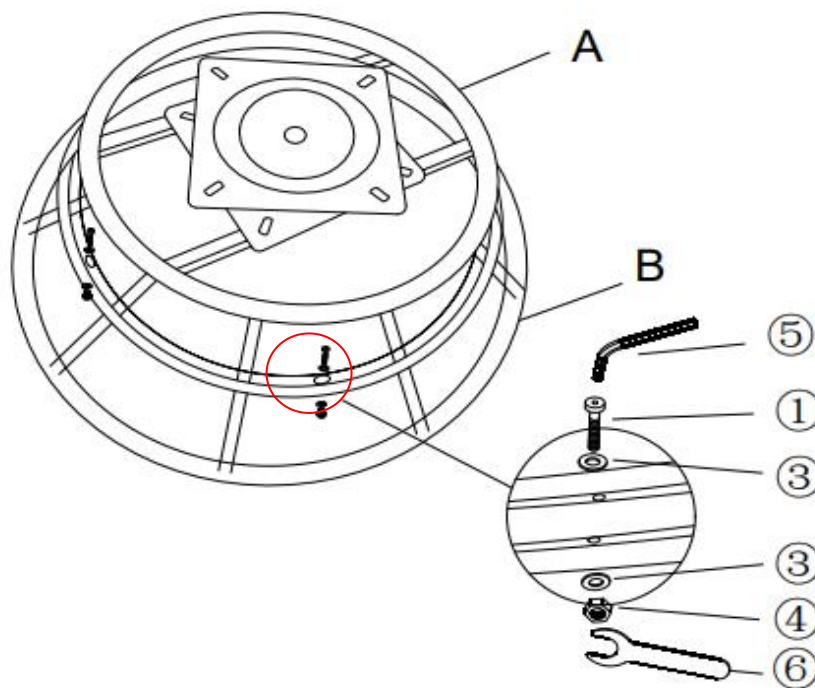

Place the Turnplate (A) and Round Base(B) on a clean, non-marring surface.

Attach Turnplate (A) to Round Base (B) using Bolts(①) & Washer(③) on one side and Washer(③) & Nut(④) on the other side, with Allen Wrench(⑤) and Spanner(⑥).

**Fully tighten the Bolts.**

### Step 3

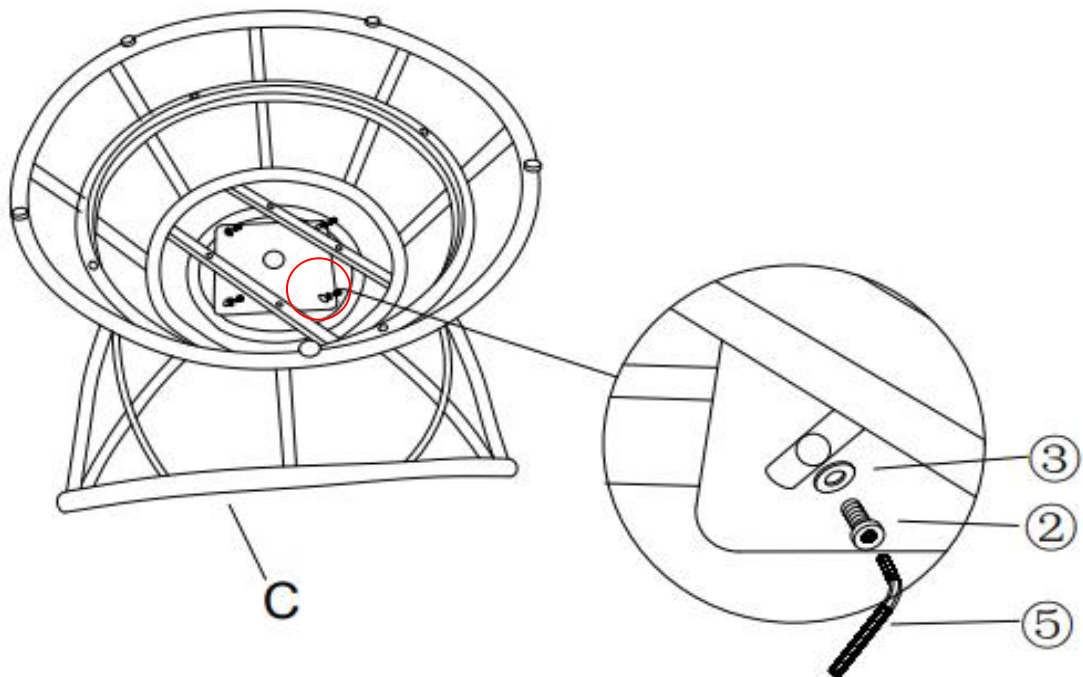

Attach Turnplate(A) to Seat Part (C) using Bolts(②) and Washer(③) with Allen Wrench(⑤).

**Fully tighten the Bolts.**

### Step 4

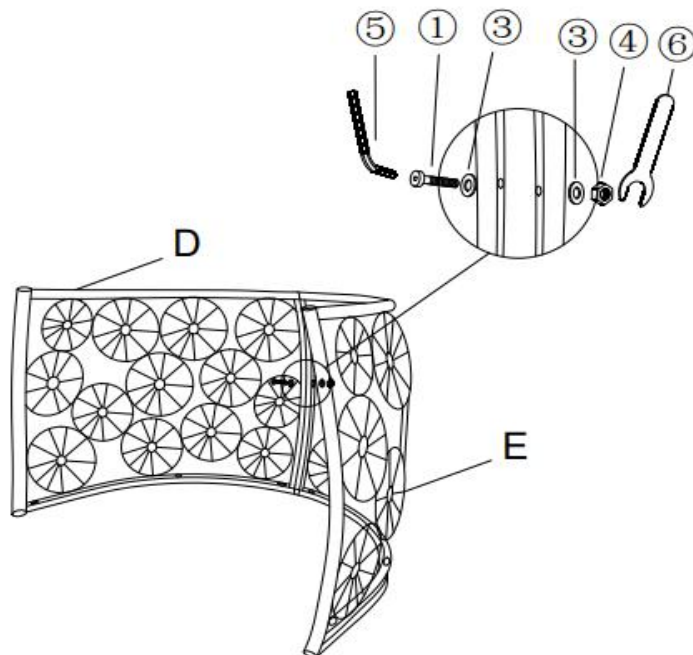

Attach Left Part (D) to Right Part (E) using Bolts(①) & Washer(③) on one side and Washer(③) & Nut(④) on the other side, with Allen Wrench(⑤) and Spanner(⑥).

**Do not fully tighten the Bolts.**

## Step 5

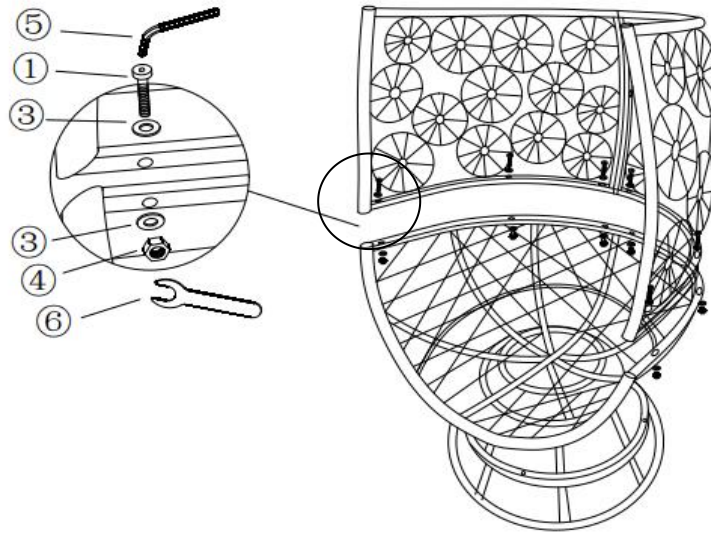

With the help of your adult partner, turn over the part of Step 3.

Attach Left Part (D) and Right Part (E) to Seat Part (C) using Bolts(①) & Washer(③) on one side and Washer(③) & Nut(④) on the other side, with Allen Wrench(⑤) and Spanner(⑥).

**Do not fully tighten the Bolts.**

## Step 6

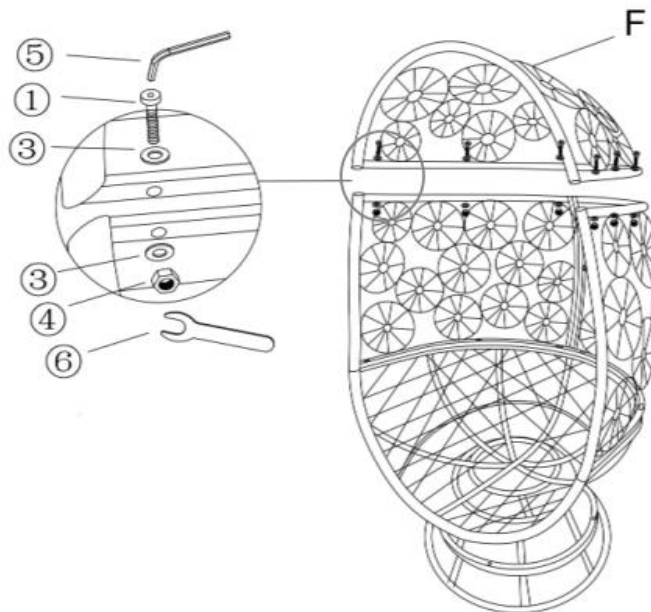

Attach Top Part (F) to Left Part (D) and Right Part (E) using Bolts(①) & Washer(③) on one side and Washer(③) & Nut(④) on other other side, with Allen Wrench(⑤) and Spanner(⑥).

**Tighten Bolts fully in a sequential manner after all Bolts are in place.**

## Step 7

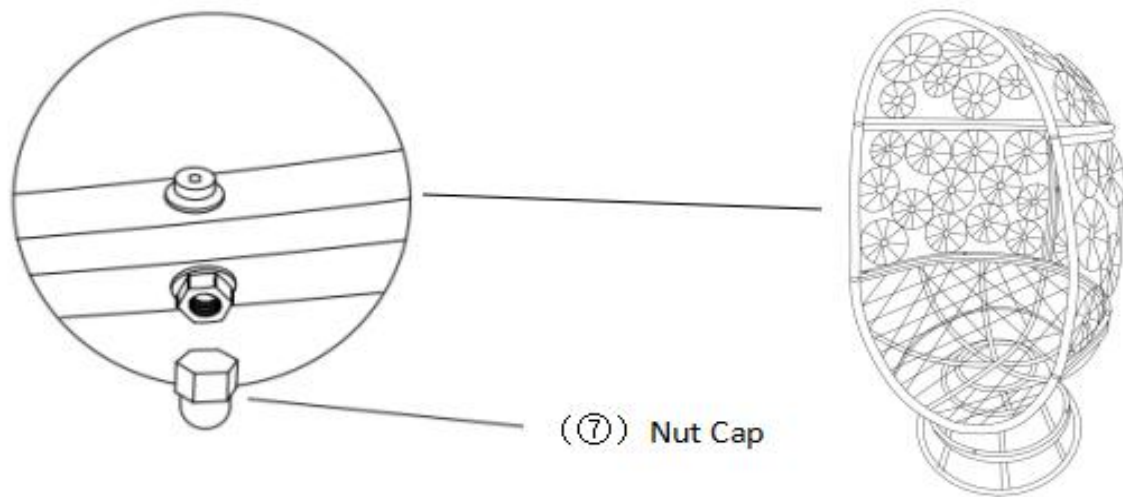

Cover all the nuts with Nut Cap(⑦) after all the bolts are tightened.

## Step 8

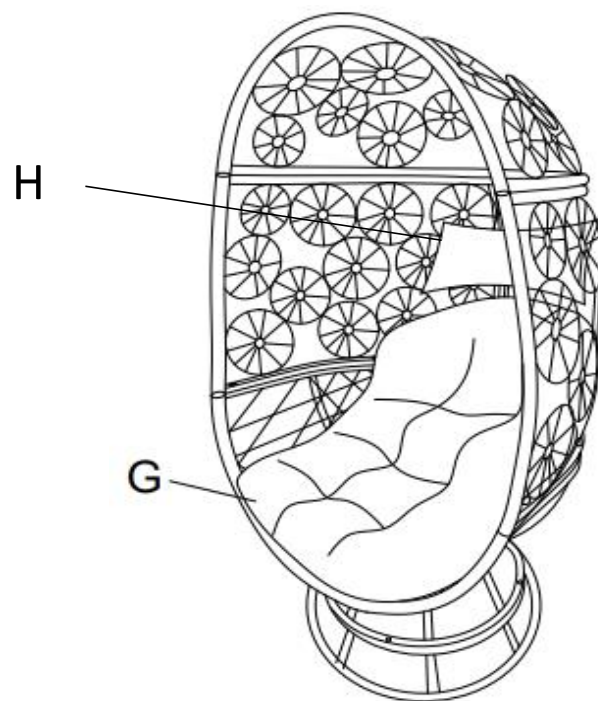

Put Cushion(G) and Pillow (H) to the chair and fix them with cushion tie.

Your chair is ready for use.

This Chair can only be used on a flat and level surface.

## Questions & Answers about Proposition 65

- What is Proposition 65?

Proposition 65 requires businesses to provide warnings to Californians about significant exposures to chemicals that cause cancer, birth defects or other reproductive harm. These chemicals can be in the products that Californians purchase, in their homes or workplaces, or that are released into the environment. By requiring that this information be provided, Proposition 65 enables Californians to make informed decisions about their exposures to these chemicals.

Proposition 65 also prohibits California businesses from knowingly discharging significant amounts of listed chemicals into sources of drinking water.

Proposition 65 requires California to publish a list of chemicals known to cause cancer, birth defects or other reproductive harm. This list, which must be updated at least once a year, has grown to include approximately 900 chemicals since it was first published in 1987.

- What types of chemicals are on the Proposition 65 list?

The list contains a wide range of naturally occurring and synthetic chemicals that include additives or ingredients in pesticides, common household products, food, drugs, dyes, or solvents. Listed chemicals may also be used in manufacturing and construction, or they may be byproducts of chemical processes, such as motor vehicle exhaust.

- What does a warning mean?

If a warning is placed on a product label or posted or distributed at a workplace, a business, or in rental housing, the business issuing the warning is aware or believes that it is exposing individuals to one or more listed chemicals.

By law, a warning must be given for listed chemicals unless the exposure is low enough to pose no significant risk of cancer or is significantly below levels observed to cause birth defects or other reproductive harm.

- Where can I get more information on Proposition 65?

If you have specific questions on the administration or implementation of Proposition 65, you can contact OEHHA's Proposition 65 program at [P65.Questions@oehha.ca.gov](mailto:P65.Questions@oehha.ca.gov), or by phone at (916) 445-6900.