

# USE AND CARE GUIDE

KBS-66K002SMTY

KBS-52K138SMTY



**Please scan the below QR code to get the video for easy installation.**



**Questions or Support?**

Email: [sofucor\\_service@163.com](mailto:sofucor_service@163.com)

Email: [sofucorceilingfan@163.com](mailto:sofucorceilingfan@163.com)

Website: [www.sofucorfan.com](http://www.sofucorfan.com)

# 01 Table of Contents

Safety Information .....	1	Remote control manual .....	13
Warranty .....	2	Match code .....	14
Three ceiling installation methods .....	3	Fans Balance .....	15
Accessory drawing .....	4	Care and cleaning .....	16
Installation procedure .....	5	Trouble shooting .....	16
		Connecting Smart Systems .....	17

# 02 Safety Information

**READ ALL SAFETY INFORMATION AND INSTALLATION INSTRUCTIONS BEFORE YOU BEGIN INSTALLING THE FAN AND SANE INSTRUCTIONS.**



**Warning:**  
**Kindly turn off the power when connecting cables.**



**OFF!!**

1. To reduce the risk of electric shock, ensure the electricity has been turned off at the circuit breaker or fuse box before you begin.
2. All wiring must be in accordance with the National Electrical Code ANSI/NFPA 70-1999 and local electrical codes. Electrical installation should be performed by a qualified licensed electrician.
3. The outlet box and support structure must be securely mounted and capable of reliably supporting 35 lbs. (15.9 kg) Use only UL Listed outlet boxes marked "Acceptable for Fan Support of 35 lbs. (15.9 kg) or less".
4. The fan must be mounted with a minimum of 7 ft. (2.1 m) clearance from the trailing edge of the blades to the floor.
5. Do not place objects in the path of the blades.
6. To avoid personal injury or damage to the fan and other items, use caution when working around or cleaning the fan
7. Electrical diagrams are for reference only. Light kits that are not packed with the fan must be UL-listed and marked suitable for use with the model fan you are installing. Switches must be UL General Use Switches. Refer to the instructions packaged with the light kits and switches for proper assembly.
8. After making electrical connections, spliced conductors should be turned upward and pushed carefully up into the outlet box. The wires should be spread apart with the grounded conductor and the equipment-grounding conductor on one side of the outlet box.
9. All setscrews must be checked and re-tightened where necessary before installation.



**WARNING:** To reduce the risk of personal injury, do not bend the blade brackets (also referred to as flanges) during assembly or after installation. Do not insert objects in the path of the blades.



**WARNING:** To reduce the risk of fire or electric shock, this fan is NOT suitable for use with solid-state speed controls.



**WARNING:** To avoid possible electrical shock, make sure that the electricity is turned off at the main power box before starting work. If you feel you do not have enough electrical wiring knowledge or experience, contact a licensed electrician.



**WARNING:** Electrical diagrams are for reference only. Optional use of any light kit shall be UL-listed and marked suitable for use with this fan



**WARNING:** To reduce the risk of fire, electrical shock or personal injury, ensure that the fan mounting bracket is supported directly from the building structure or the outlet box marked "Acceptable for Fan Support of 35 lbs. (15.9 kg) or less". Use only the screws provided with the outlet box.

## 03 Warranty

---

The supplier warrants the fan motor to be free from defects in workmanship and material present at time of shipment from the factory for a lifetime after the date of purchase by the original purchaser. The supplier also warrants that all other fan parts, excluding any glass or acrylic blades, to be free from defects in workmanship and material at the time.

of shipment from the factory for a period of two years after the date of purchase by the original purchaser. We agree to correct such defects without charge or at our option replace with a comparable or superior model if the product is returned.

To obtain warranty service, you must present a copy of the receipt as proof of purchase. All costs of removing and re-installing the product are your responsibility. Damage to any part such as by accident, misuse, improper installation, or by affixing any accessories, is not covered by this warranty.

Because of varying climatic conditions this warranty does not cover any changes in brass finish, including rusting, pitting, corroding, tarnishing, or peeling. Brass finishes of this type give their longest useful life when protected from varying weather conditions. A certain amount of "wobble" is normal and should not be considered a defect.

Servicing performed by unauthorized persons shall render the warranty invalid. There is no other express warranty. Sofucor hereby disclaims any and all warranties, including but not limited to those of merchant ability and fitness for a particular purpose to the extent permitted by law. The duration of any implied warranty which cannot be disclaimed is limited to the time period as specified in the express warranty. Some states do not allow a limitation on how long an implied warranty lasts, so the above limitation may not apply to you.

The retailer shall not be liable for incidental, consequential, or special damages arising out of or in connection with product use or performance except as may otherwise be accorded by law. Some states do not allow the exclusion of incidental or consequential damages, so the above exclusion or limitation may not apply to you. This warranty gives specific legal rights, and you may also have other rights which vary from state to state. This warranty supersedes all prior warranties. Shipping costs for any return of product as part of a claim on the warranty must be paid by the customer.

## 04 Three ceiling installation methods

### Concrete Ceiling Mounting Bracket

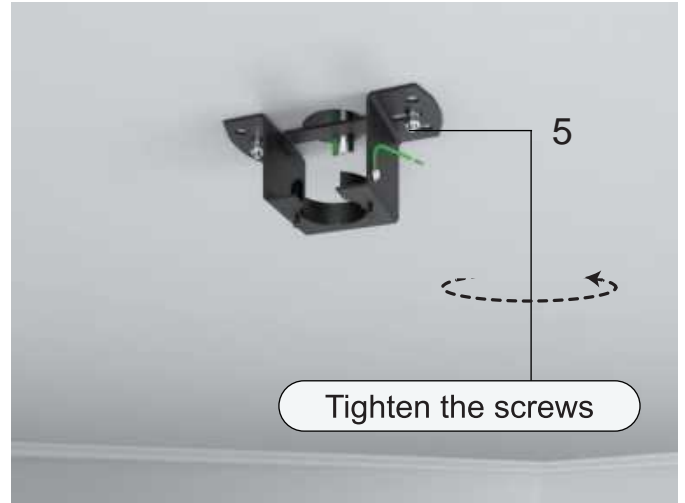
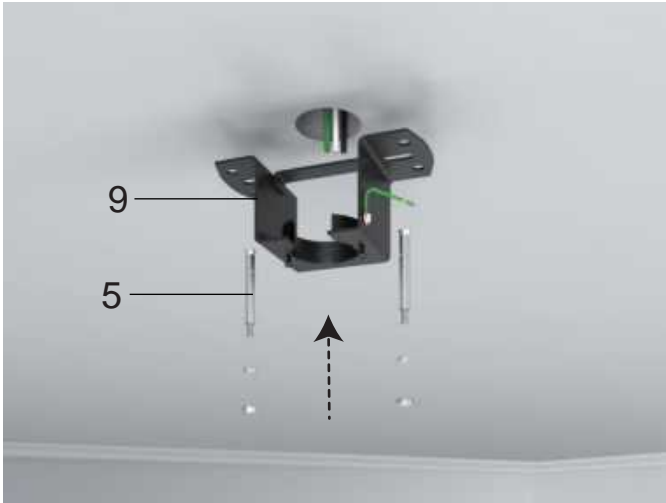

### Hanger for Junction Box Mounting Bracket

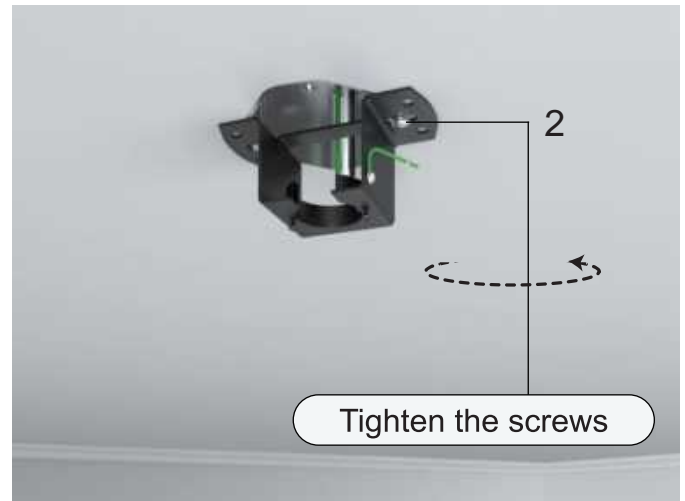
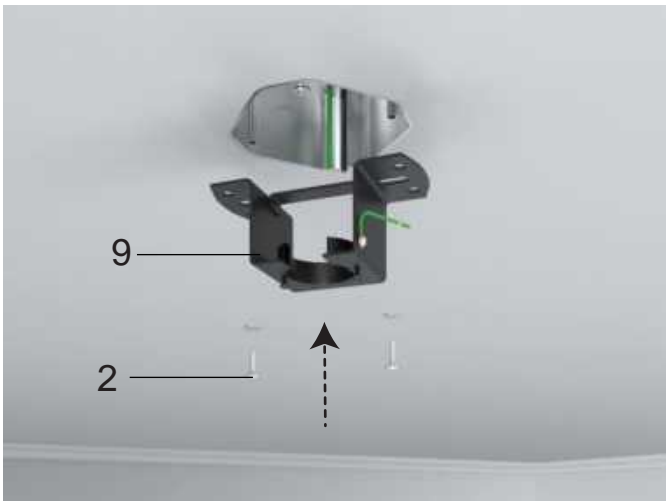

### Wooden ceiling Mounting Bracket

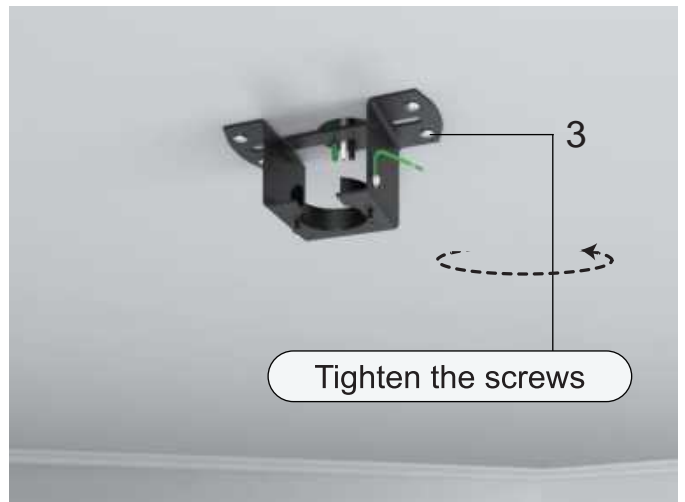
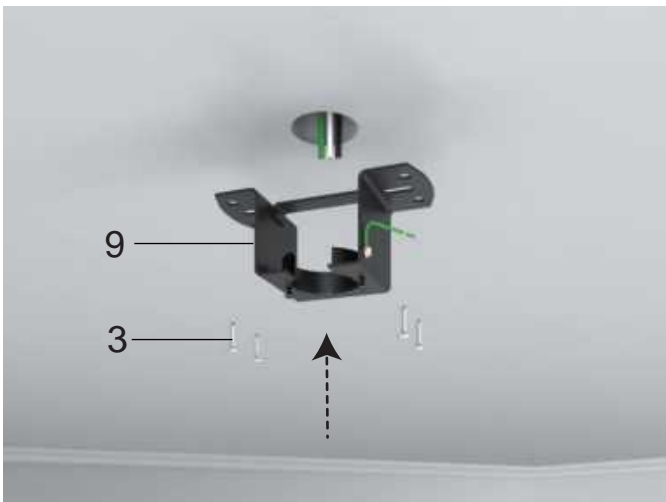

# 05 Accessory drawing

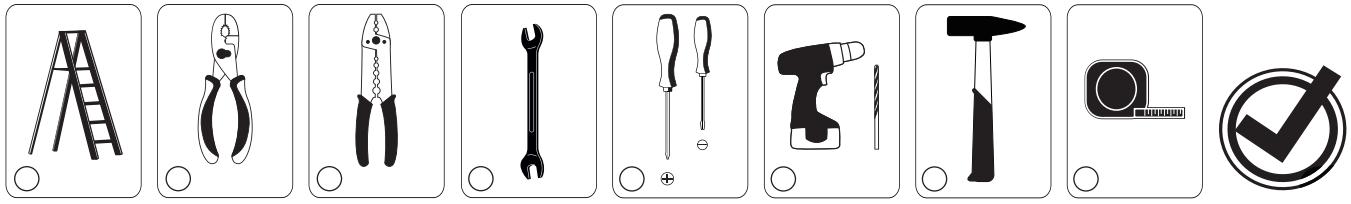

## 06 Installation procedure

### Install the blades

1. Connect the blades and spokes



2. Pay attention to the front and back



3. Take out the screws



4. Install the blades, Retighten the screws



## 06 Installation procedure

### Install the light plate

5. Loosen two screws, take out one

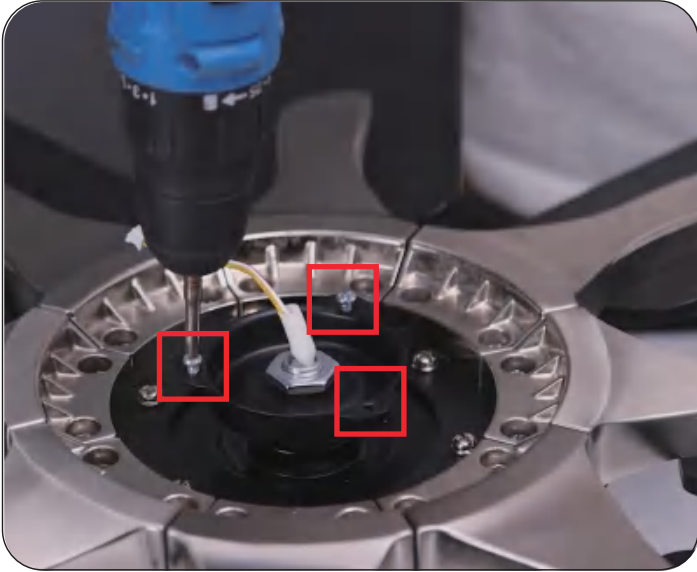

6. Install lamp plate, Retighten the three screws

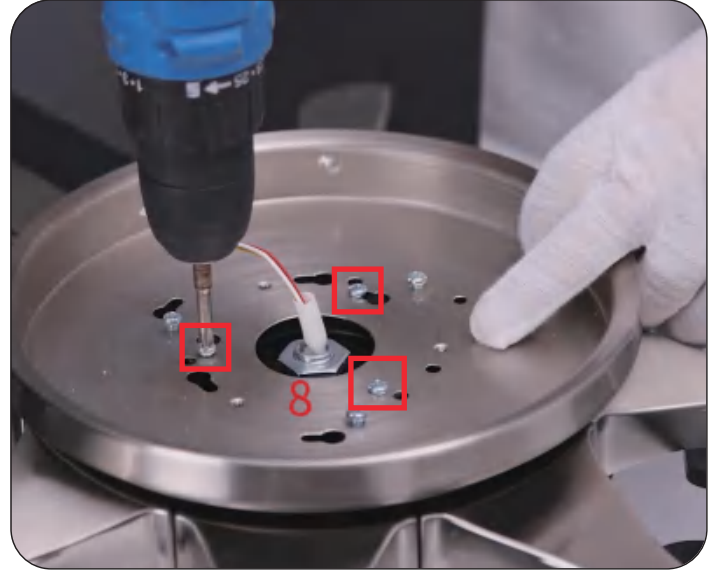

7. Loosen the original screws on the light plate

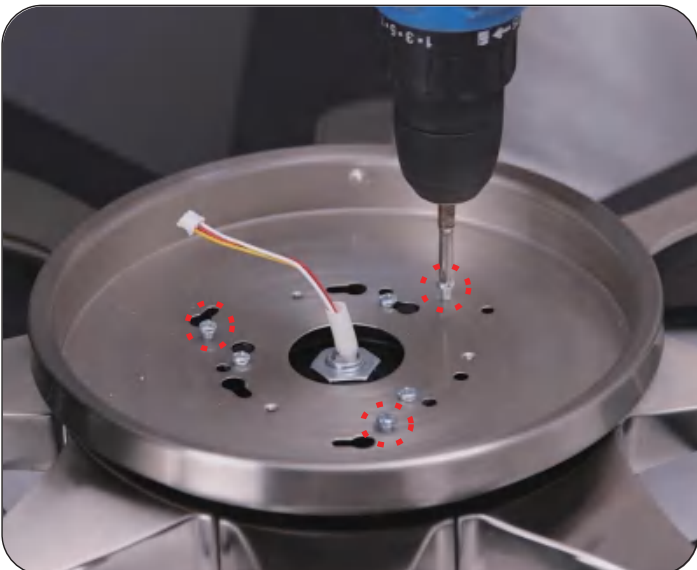

8. Connect the light source with the wires from the motor

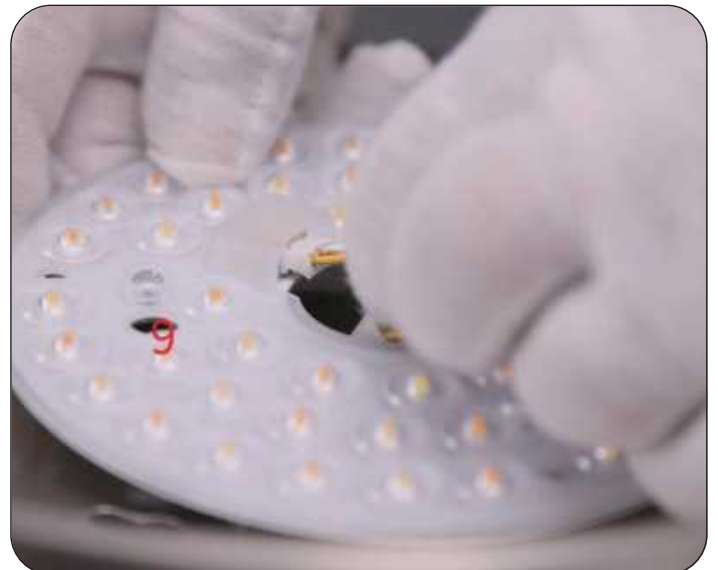

## 06 Installation procedure

### Install the downrod

9. Retighten the three screws



10. Disassemble the downrod(No.15)



11. Thread the motor wires into the rod



12. Fastened with screws and fixing clips



## 06 Installation procedure

### Install the coverage

13. Tighten the screws



14. Put the decorative cover(No.1) through the downrod



15. Put the canopy cover(No.10) through the downrod



16. Put the canopy(No.3) through the downrod



## 06 Installation procedure

### Install the rod ball

17. Put the rod ball through the downrod



18. Put the lock washer to the hole of the downrod and push the rod ball to the top of the downrod

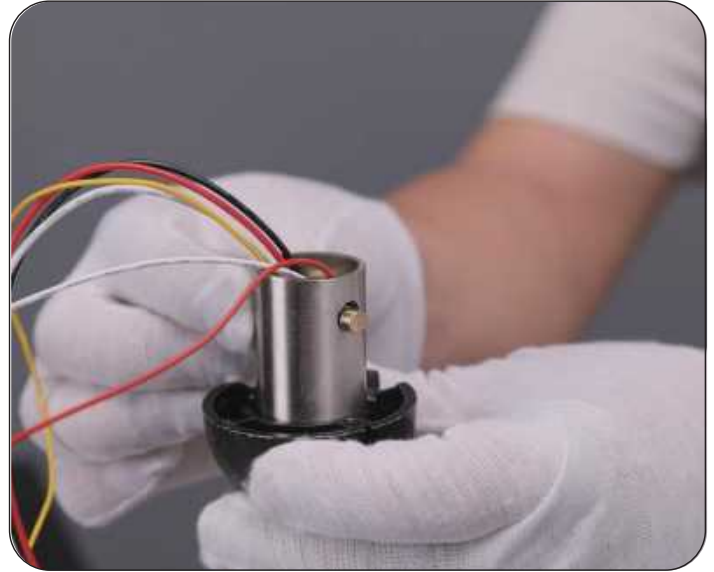

19. Find the green ground wire to the hole of the rod ball and the down rods,  
Tighten the screw

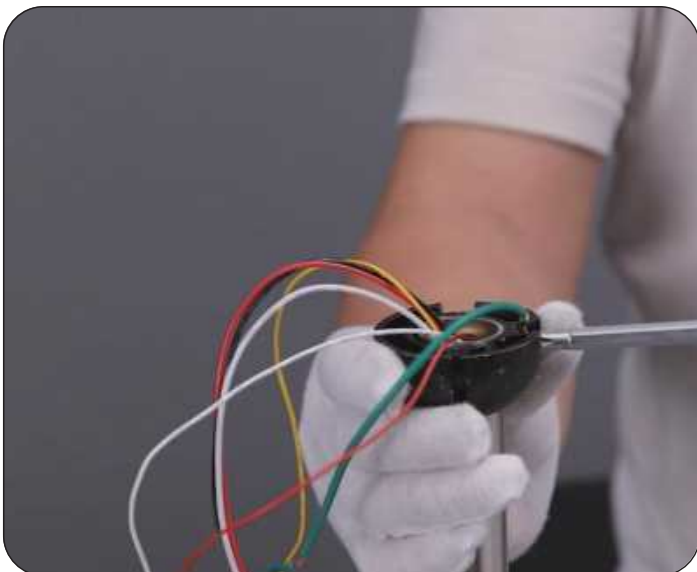

# 06 Installation procedure

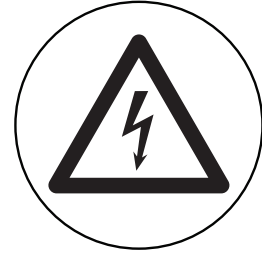

**OFF!!**

 **WARNING:** Remove the rubber motor stops on the bottom of fan before installing the blades or testing the motor.

 **WARNING:** Turn off the electric power during installation and making wire connection.

1. Connect the wire which from ceiling fan into the receiver.
2. Connect the wire from receiver with the wire from house.

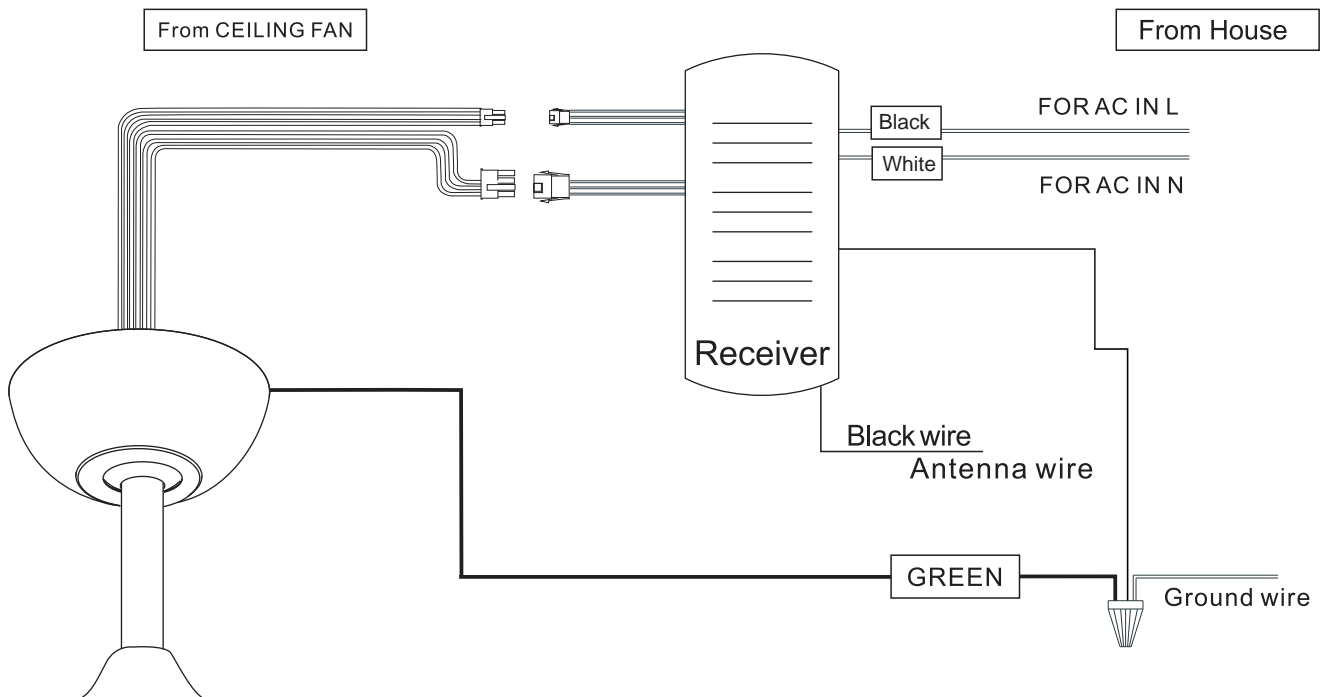

## 06 Installation procedure

### Wiring and installation

20. Connect the wire from the ceiling fan to the receiver(No.1-Red, White and Black wires)( No.2-Red, White and Yellow wires)

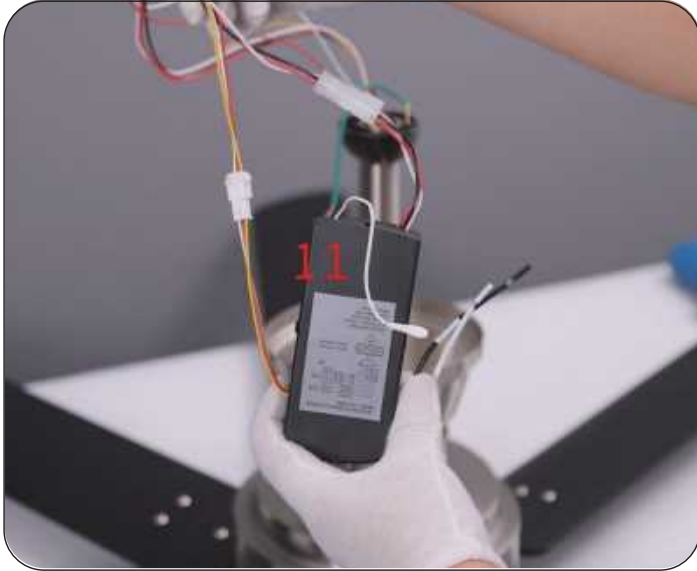

21. Install the mounting bracket, tighten the screw

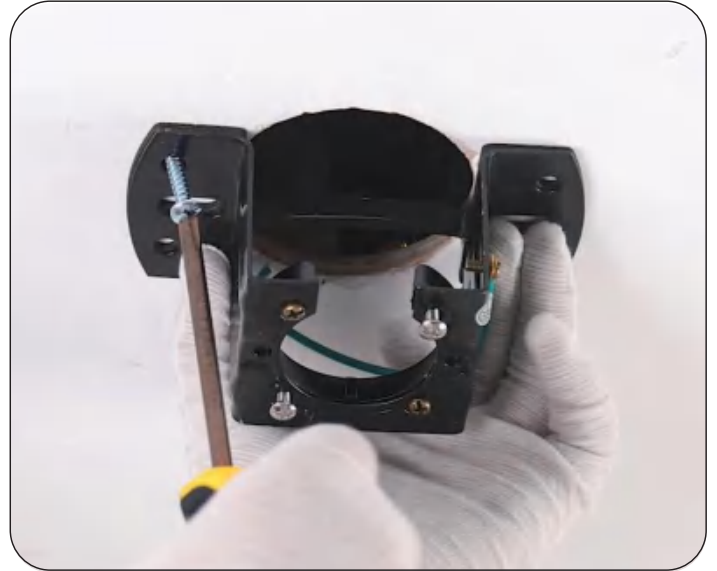

22. Install to ceiling mounting bracket

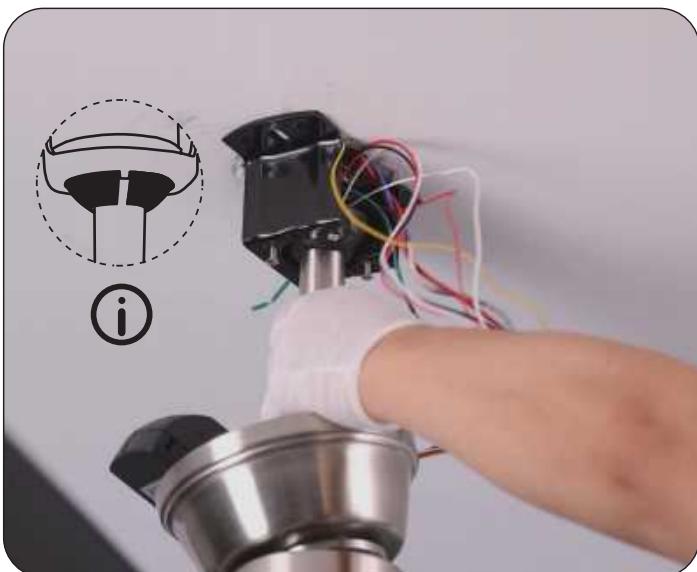

23. Install the receiver, connect the black and white wire, and put it into the slide-on mounting bracket

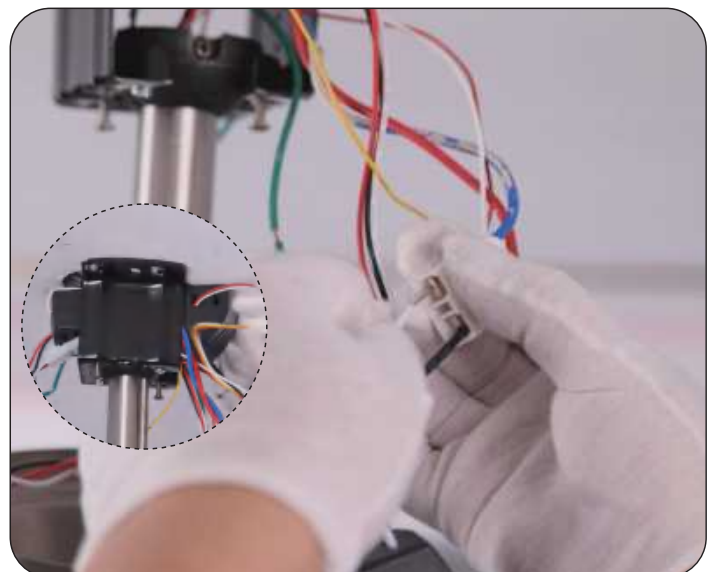

## 06 Installation procedure

### Fixed coverage

24. Cover the canopy.



25. Tighten the screw



26. Push the canopy cover to the canopy



27. Installing the light cover



## USER MANUAL FOR REMOTE CONTROL TRANSMITTER

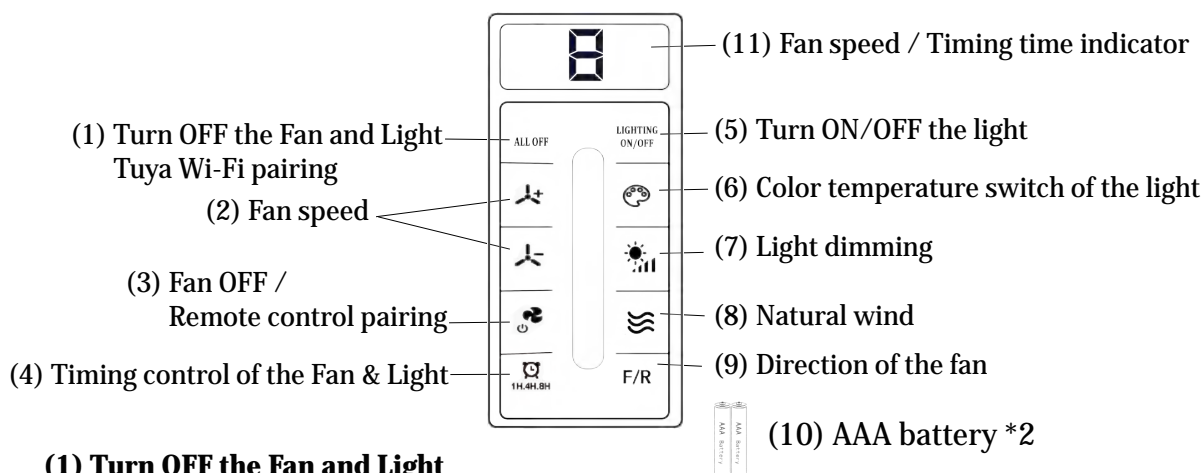

### (1) Turn OFF the Fan and Light

- Press the key to turn OFF the Fan and Light together.
- **Tuya Wi-Fi pairing:** Press and hold the key for 4 seconds, you can hear three long beep sounds, then you can do Tuya Wi-Fi pairing. Please refer to the product manual for the distribution method.

### (2) Fan speed

- Press the key 1-6 to start the fan.
- When the fan is in natural wind mode, press the key to cancel natural wind mode.

### (3) Fan OFF / Remote control pairing

- Turn OFF the fan.
- **Remote control pairing:** when AC power on, press and hold the key for 3-5 seconds, buzzer rings three times (if buzzer sound enable), then finish the remote control pairing.

Notice:

The remote controller only needs to be paired once. After the paired product, the controller will have memory. The products have been paired before leaving the factory. When the remote control is damaged or lost, it is necessary to implement remote control pairing before using a new remote control.

### (4) Timing control of the Fan and Light

- Press the key to set up the timer at 1 hour, 4 hours or 8 hours to set up fan and lamp timer. At the end of the timing, the fan and lamp will be automatically turned off.
- When the timing function is in effect, you can operate all the functions of the ceiling fan, and then press any timing button to recalculate the timing time.
- Timer setting cancellation: When timing function is working, press key (1) or (3) to cancel the timing function.

### (5) Turn ON/OFF the Light

### (6) Color temperature Switch of the light

Press the key to change LED light color: white-yellow-warm (circulate).

### (7) Light dimming

When the light is on, press and hold the key, the light gradually brightens - gradually dimmed (circulate).

### (8) Natural wind

Press the key, the fan speed automatically changes between 1 to 6 speed.

### (9) Direction of the fan

Press the key to change direction of the fan.

### (10) AAA battery \* 2

- Please install 2 pieces of AAA batteries before use.
- Please remove the battery when it is not used for a long time.

### (11) Fan speed and Timing time indicator

The indicator light will light up when press any key of the remote control.

**Note: the remote control must match the same code receiver**



After the reversible button is pressed, the fan slowly slows down to a stop. And then it started to reverse.

## 08 Match code



if it does not work

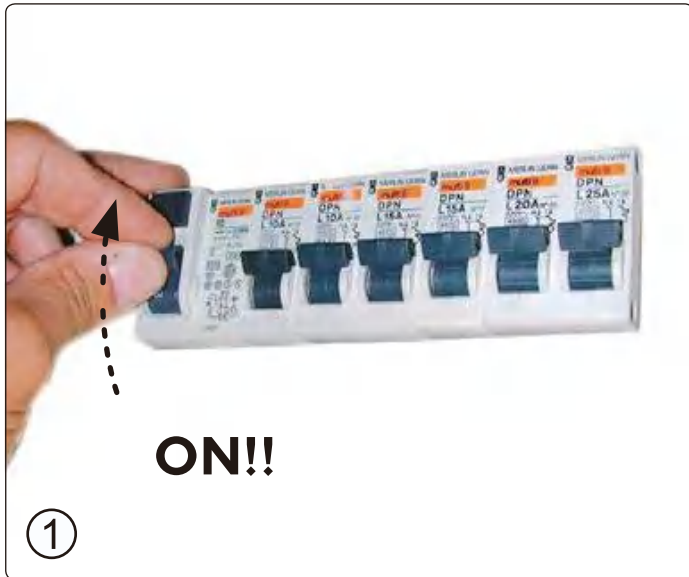

1. Turn on the main switch.



2. Remote control pairing : when AC power on, press and hold the key for 3-5 seconds, buzzer wrights three times (if buzzer sound enable), then finish the remote control pairing.

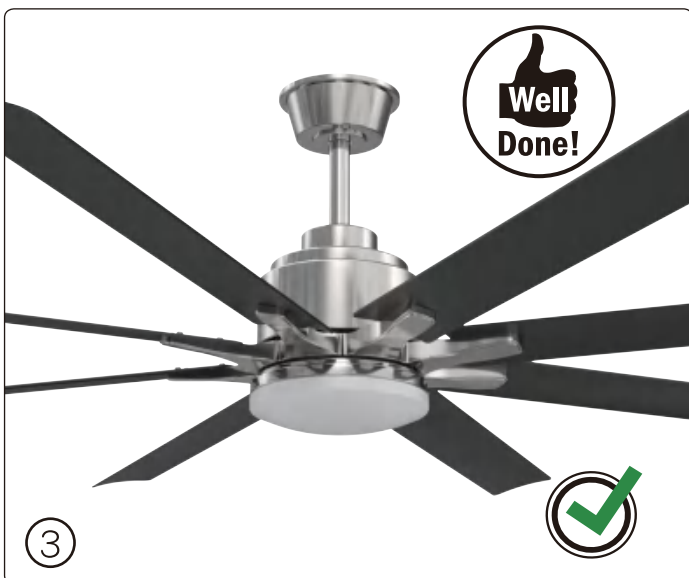

3. The receiver Can remember the last codes status.

Remote control code matching successful, the receiver will emit a buzzing sound.

## 09 Fans Balance

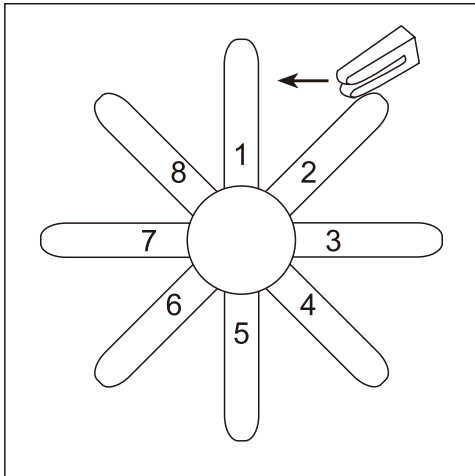

Slide the balancing clip on the trailing edge of any blade, halfway between the holder and tip. Run the fan to check the wobble. If the wobble persists, repeat with each blade, noting which one most reduced the wobble.

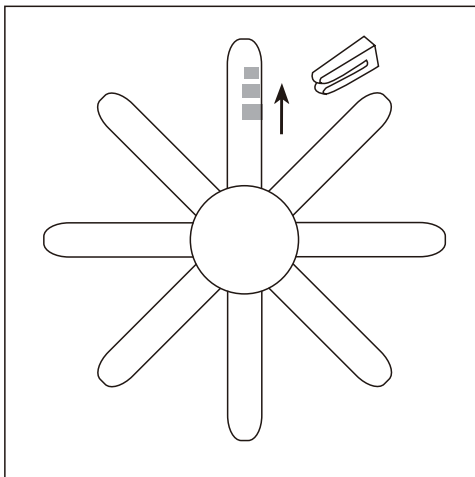

Slide the clip in small increments away from the center of that blade. Move the clip, operate the fan, then move it again until you eliminate as much wobble as possible.

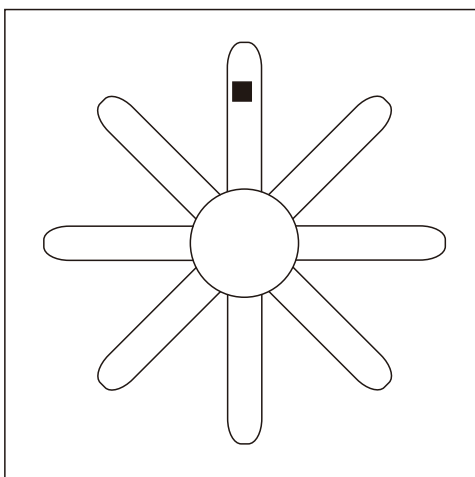

Stick the adhesive-backed balancing weight on the top center of the blade directly in line with the balancing clip. Add more weight if needed to get a smooth-running fan.

# 10 Care and Cleaning

 **WARNING:** Make sure the power is off before cleaning your fan.

- Because of the fan's natural movement, some connections may become loose. Check the support connections, brackets, and blade attachments twice a year. Make sure they are secure. It is not necessary to remove the fan from the ceiling.
- Clean your fan periodically to help maintain its new appearance over the years. Do not use water when cleaning, as this could damage the motor, or the wood, or possibly cause an electrical shock. Use only a soft brush or lint-free cloth to avoid scratching the finish. The plating is sealed with a lacquer to minimize discoloration or tarnishing.
- You can apply a light coat of furniture polish to the wood for additional protection and enhanced beauty. Cover small scratches with a light application of shoe polish.
- You do not need to oil your fan. The motor has permanently-lubricated sealed ball bearings.

# 11 Trouble shooting

Problem	Solution
The fan will not start.	<ul style="list-style-type: none"> <li>□ Check the main and branch circuit fuses or breakers.</li> <li>□ Check the line wire connections to the fan and switch wire connections in the switch housing.</li> </ul>
The fan is noisy.	<ul style="list-style-type: none"> <li>□ Ensure all motor housing screws are snug.</li> <li>□ Ensure the screws that attach the fan blade bracket to the motor hub are tight.</li> <li>□ Ensure the wire nut connetions are not ratting against each other or the interior wall of the switch housing.</li> <li>□ Allow a 24-hour "breaking in" period. Most noises associated with a new fan disappear during this time.</li> <li>□ If you are using the Ceiling Fan light kit,ensure the screws securing the glassware are tight.Check that the light bulbs are also secure.</li> <li>□ Ensure the canopy is a short distance from the ceiling.It should not touch the ceiling.</li> <li>□ Ensure your outlet box is secure and rubber isolator pads wereused between the mounting plate and outlet box.</li> </ul>
The fan wobbles.	<ul style="list-style-type: none"> <li>□ Please check and follow the instructions: Chapitre No.12 Fan balance on page 13.</li> </ul>

If you have any questions, please contact us. We will help you solve any problem.

**Email:sofucor\_service@163.com**  
**Email:sofucorceilingfan@163.com**  
**Website: www.sofucorfan.com**



# Connecting Smart Systems User Manual

## 1. Connecting with Mobile Phone APP

Search for “Smart Life” in the App store or scan the QR code to download the “Smart Life” app

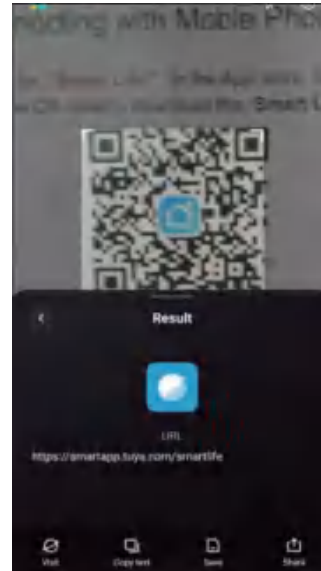

## 2. Register and log in APP

After downloading and opening the APP, register and log in the APP according to the options.

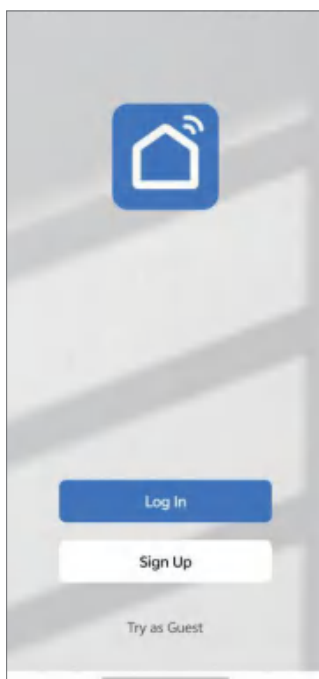

## 3. Add smart devices

Add smart devices, and ensure WIFI 2.4GHz and Bluetooth are stably connected in subsequent scanning and connection. 5GHz and 5.8GHz are not supported.

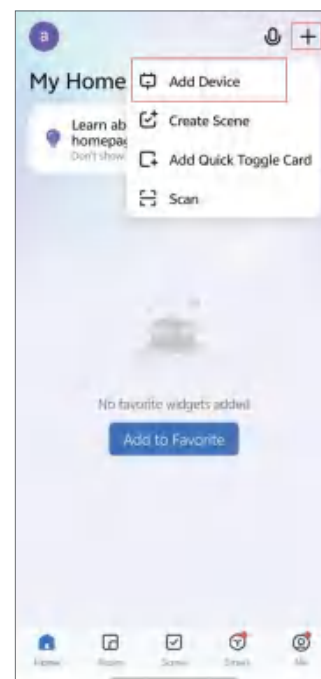

#### 4. Initial automatic scan for connected devices

If the fan has been operating for more than 3 minutes, you will be unable to search for devices. At this point, you need to reset your fan. Turn off the fan's main power and turn it back on. Within 30 seconds, press and hold the "ALL OFF" button on the remote control for 5 seconds. If the reset is successful, the buzzer will sound three long beeps, then you can add devices again.

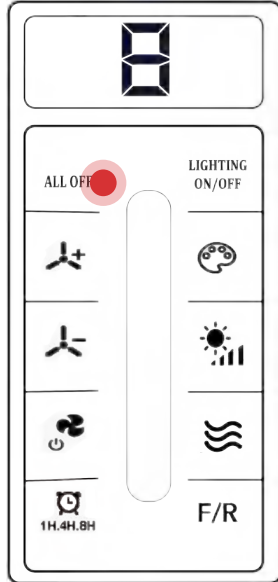
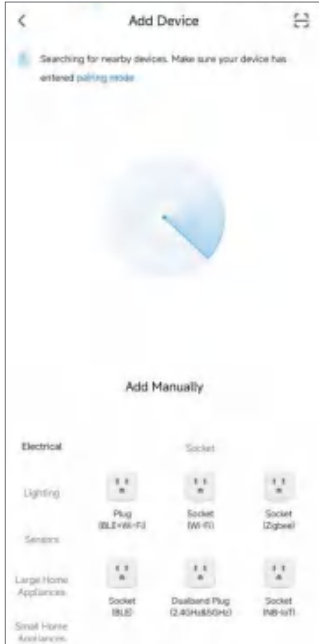

#### 5. Select the scanned fan

Tap the corresponding icon to connect.



#### 6. APP connection to WIFI

Enter the connected WIFI name and password.



#### 7. The fan is paired with the APP

- ① After the pairing is completed, you can customize the fan's name
- ② If pairing fails, please check whether the Wifi network and password are correct. If connection fails after multiple attempts, try connecting the fan manually as shown in Step 8 below.



## 8. Open the fan connection manually

Select "Fan" in "Lighting" (Bluetooth +WIFI).



## 8-1. Follow the prompt

After performing Steps ① and ②, once hear three consecutive beeps from the buzzer, tap "Next" in Step ③ to proceed to the network pairing procedure.

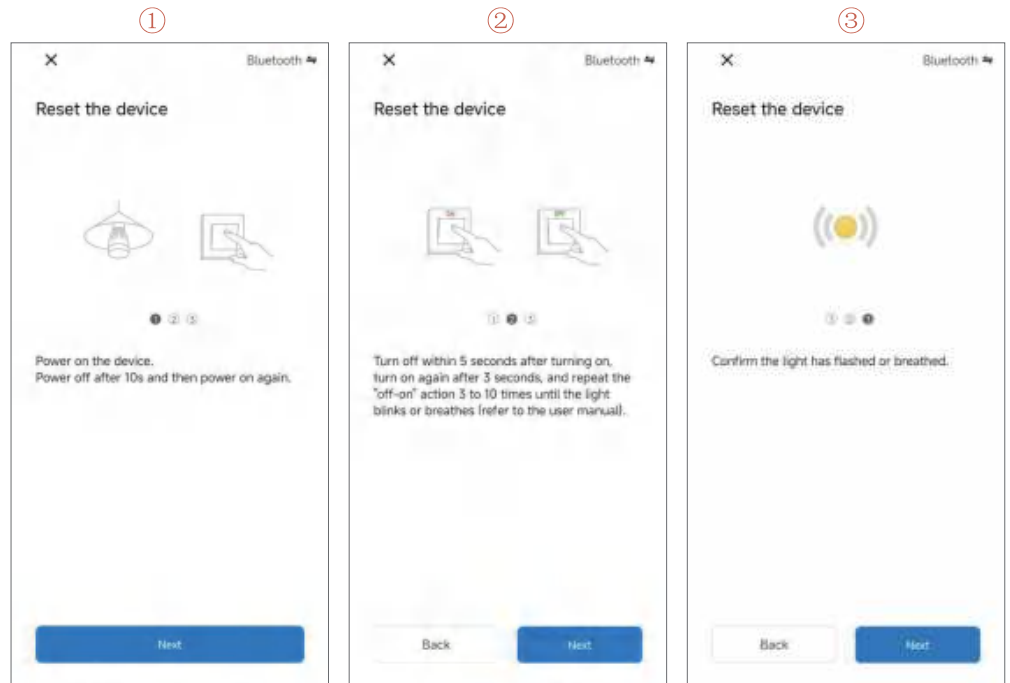

## 8-1. Follow the prompt

- ① Select 2.4 GHz Wi-fi Network and enter password.
- ② Connect your mobile phone to the device's hotspot.
- ③ Device Adding Timeout, Check demerit points and retry.
- ④ Follow the picture instructions to set up the device.

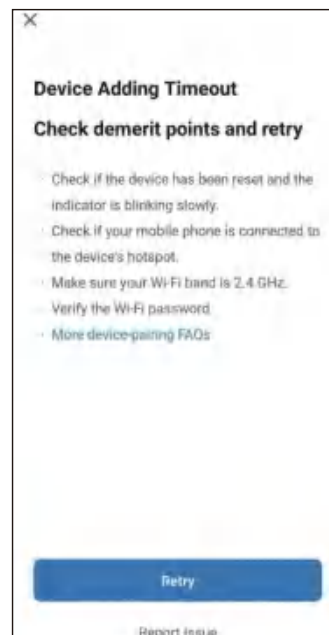
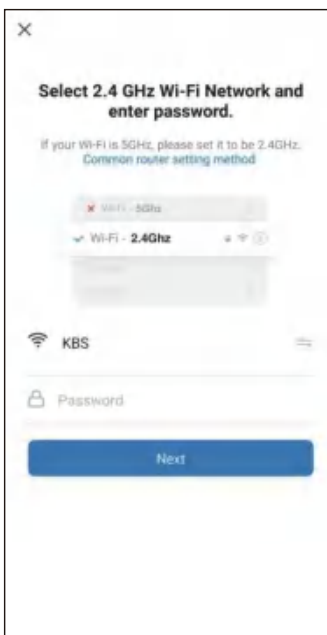

## 8-2. Manually finding a fan is complete

Manually find the fan successfully, start the connection (refer to 7).

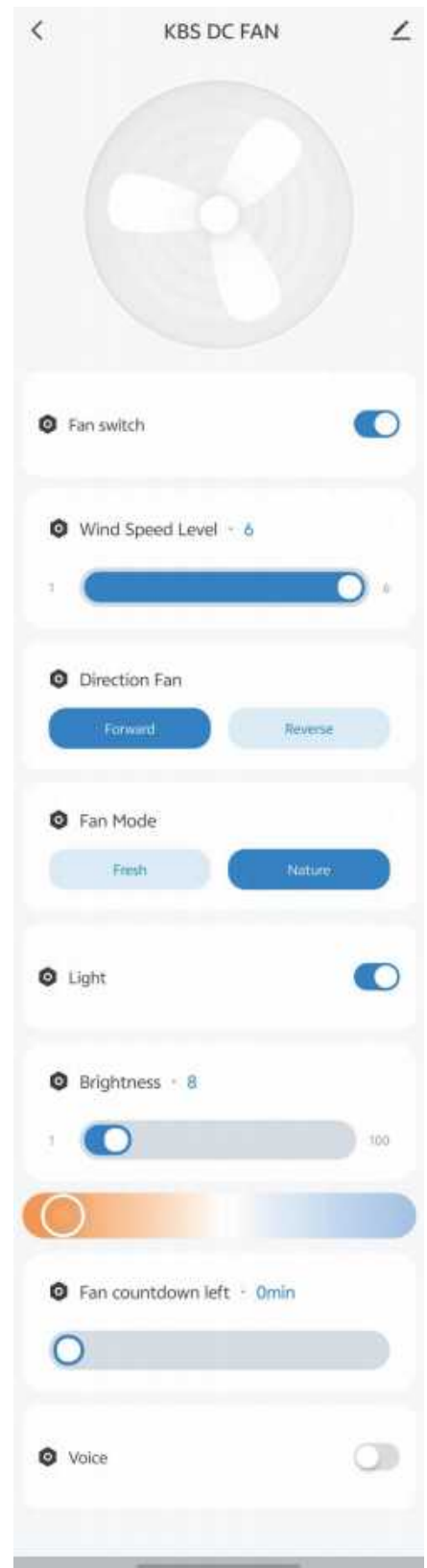
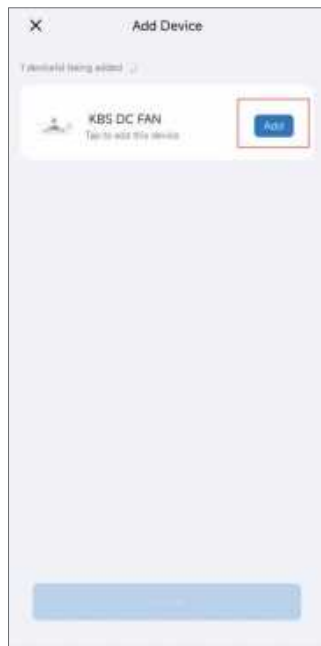

## 9. Connect successfully and enter the control interface

According to the interface, free adjustment.

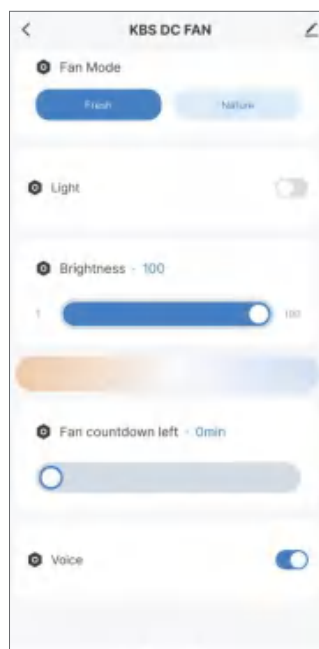
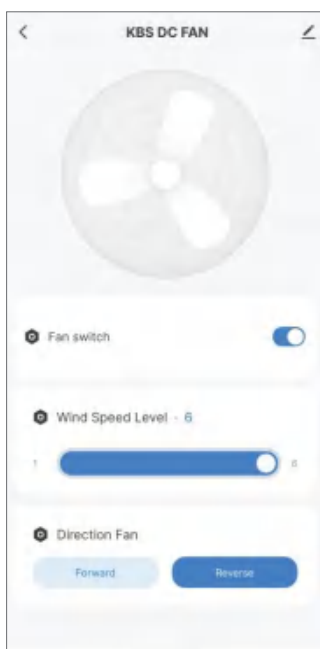

# Link skill to the Amazon Echo or Google Assistant

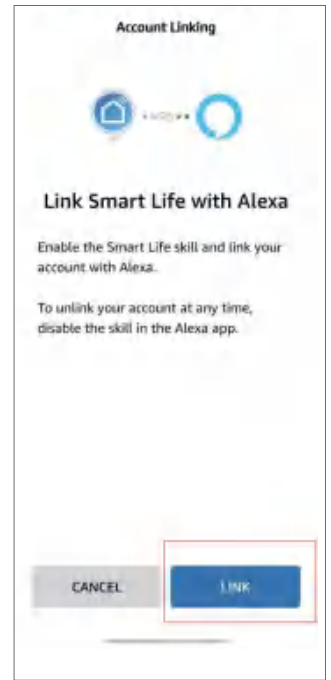
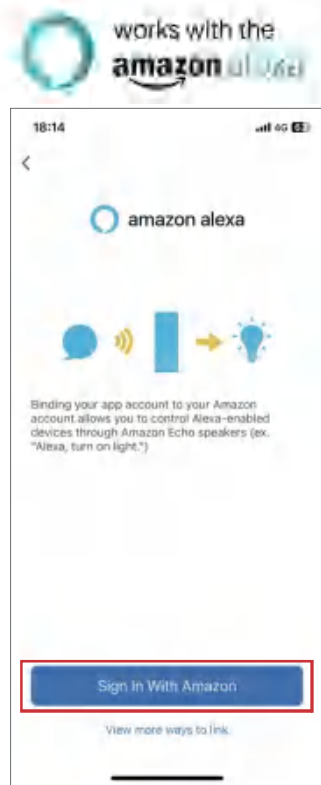
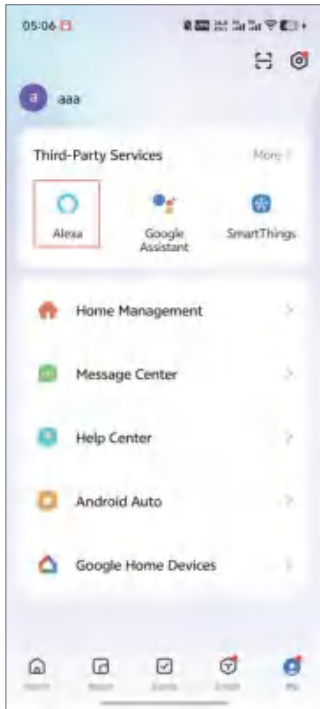

In the App, change the name of the device to an easily identifiable name such as bedroom light, bedroom fan.

Make sure your Amazon Echo device is powered on and connecting to your home Wi-Fi network.

## Common commands

- △ KBS DC Fan: <DEVICE NAME>
- Alexa, tum on/off <DEVICE NAME>.
- Alexa, what is the <DEVICE NAME> speed?
- Alexa, set the <DEVICE NAME> speed to 1/2/3/4/5/6.
- Alexa, set the bedroom <DEVICE NAME> speed to max.
- Alexa, turn up/decrease the bedroom <DEVICE NAME> speed.
- Alexa, set the <DEVICE NAME> to forward/reverse.
- Alexa, set the mode on the <DEVICE NAME> to fresh/nature.
- Alexa, set the countdown on the <DEVICE NAME> to cancel/1 hour/2 hour/4 hour/8 hour.

△ Light: <device name>

- Alexa, tum on/off <device name>.
- Alexa, set the <device name> to fifty percent.
- Alexa, make the <device name> warm white/white/cool white.
- Alexa, brighten/dim <device name>.
- Alexa, turn on/off response.

Note: "Alexa, turn on/off voice" – Controls the buzzer switch.

This function only applies to the buzzer sound for Tuya and Alexa control; the remote handle is silent by default.

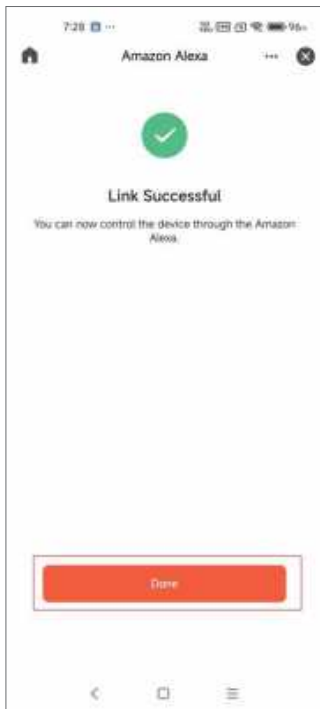

# Steps for adding to Alexa as "bedroom"

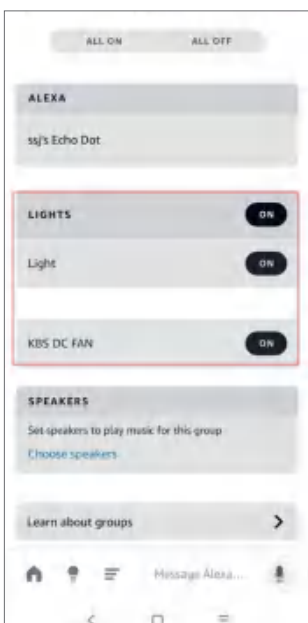
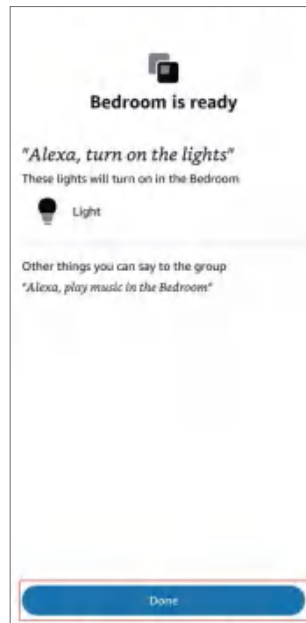
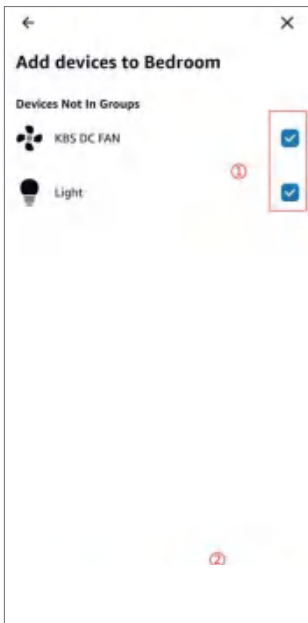
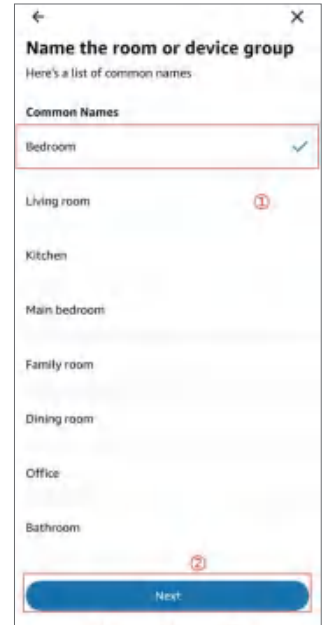
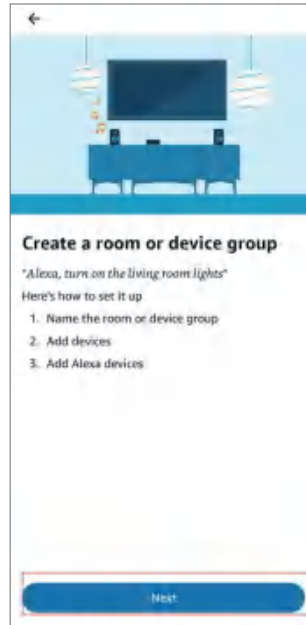
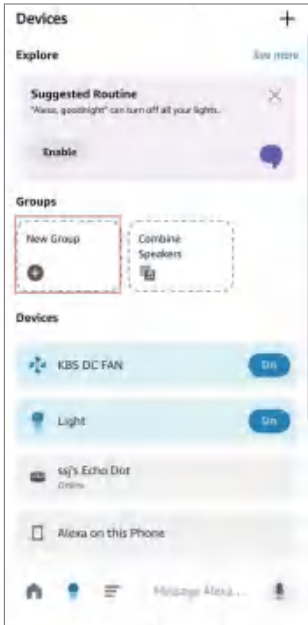



Register for Extended  
2 Years Warranty+2 Year Warranty

Within the First 7 days  
Scan QR code with your phone